

# Deutsche Meisterschaft der Schüler 2021

2021.09.19 - 2021.09.19

Horst-Korber-Sportzentrum, Am Glockenturm 3-5, 14053 Berlin

GERMANY,GER



**Deutscher Karate Verband e.V.**



# Deutsche Meisterschaft der Schüler 2021



GERMANY

2021.09.19 - 2021.09.19

Horst-Korber-Sportzentrum, Am Glockenturm 3-5, 14053 Berlin



## Statistics

Participating Countries: 1

Participating Regions: 15

Participating Team/Clubs: 118

	Competitors	Entries
Female	173	183
Male	188	207
<b>Total</b>	<b>361</b>	<b>390</b>

### Entries per Category

	Entries	Teams
Schüler A Kata Einzel Jungen	25	-
Schüler A Kata Einzel Mädchen	29	-
Schüler A Kumite Einzel Mädchen -38 kg	19	-
Schüler A Kumite Einzel Jungen +49 kg	28	-
Schüler A Kumite Einzel Jungen -38 kg	20	-
Schüler A Kumite Einzel Jungen -44 kg	27	-
Schüler A Kumite Einzel Jungen -49 kg	22	-
Schüler A Kumite Einzel Mädchen +49 kg	22	-
Schüler A Kumite Einzel Mädchen -44 kg	20	-
Schüler A Kumite Einzel Mädchen -49 kg	18	-
Schüler B Kata Einzel Jungen	19	-
Schüler B Kata Einzel Mädchen	25	-
Schüler B Kumite Einzel Jungen +38 kg	22	-
Schüler B Kumite Einzel Jungen -32 kg	20	-
Schüler B Kumite Einzel Jungen -38 kg	25	-
Schüler B Kumite Einzel Mädchen +36 kg	21	-
Schüler B Kumite Einzel Mädchen -30 kg	7	-
Schüler B Kumite Einzel Mädchen -36 kg	21	-
<b>Totals:</b>	<b>390</b>	<b>0</b>



## R1 G1/4 (6) Tatami 2 09:25

Teilnehmer	Kata	1T	1A	2T	2A	3T	3A	4T	4A	5T	5A	6T	6A	7T	7A	TEC	ATH	Extr	GesamRang
1 KOCH ALEXANDER (RPF)	061 NIPAIPO	6.6	(7.6)	6.6		(6.2)		6.6		19.8						19.8		6	
2 BRACHER JOEL (BW)	006 BASSAI DAI	(7.2)	6.8	6.8		(6.0)		7.0		20.6						20.6		5	
3 HORN DOMINIK (BER)	102 WANSHU	(8.0)	6.6	(6.4)		7.0		7.2		20.8						20.8		4	
4 REIM NICO (THÜ)	036 JION	(8.4)	8.0	(7.4)		7.4		8.2		23.6						23.6		3	
5 ALBIEN ALEXANDER (BRE)	041 KANKU SHO	(8.6)	8.6	(8.4)		8.4		8.6		25.6						25.6		1	
6 MINOR DANIEL (BAY)	041 KANKU SHO	8.2	(7.6)	(8.6)		8.2		8.4		24.8						24.8		2	

## R1 G2/4 (6) Tatami 1 09:30

Teilnehmer	Kata	1T	1A	2T	2A	3T	3A	4T	4A	5T	5A	6T	6A	7T	7A	TEC	ATH	Extr	GesamRang
1 ALF JIM (BW)	036 JION	(6.4)	(7.0)	6.6		6.6		7.0		20.2						20.2		5	
2 JAHNSMÜLLER ADRIAN (SAH)	001 ANAN	(8.0)	7.4	7.4		7.4		(7.2)		22.2						22.2		3	
3 STENSCHKE MALCOLM (BAY)	040 KANKU DAI	(7.8)	(6.8)	7.8		7.8		7.6		23.2						23.2		2	
4 SCHMIDTGEN MARC AUREL (SAC)	006 BASSAI DAI																		
5 KUMPFERT LUKAS (NRW)	012 ENPI	7.0	(8.0)	7.2		(6.2)		7.6		21.8						21.8		4	
6 KÖCHER MIKA (SAA)	012 ENPI	(8.2)	(7.4)	8.2		8.0		7.8		24.0						24.0		1	

## R1 G3/4 (6) Tatami 3 09:25

Teilnehmer	Kata	1T	1A	2T	2A	3T	3A	4T	4A	5T	5A	6T	6A	7T	7A	TEC	ATH	Extr	GesamRang
1 MOHR JAN (BAY)	006 BASSAI DAI	(7.6)	(6.8)	7.4		7.4		7.6		22.4						22.4		3	
2 GRÖPPER LEON (NRW)	036 JION	(8.0)	8.0	8.0		(8.2)		8.0		24.0						24.0		1	
3 LEHMANN FELIX (SH)	036 JION	7.0	(6.6)	7.2		(8.0)		7.0		21.2						21.2		6	
4 BÖHM LOUIS (RPF)	083 SEIPAI	7.4	(7.8)	(7.0)		7.4		7.2		22.0						22.0		5	
5 SPIES MAARTEN (HES)	083 SEIPAI	(7.6)	7.2	(6.8)		7.2		7.6		22.0						22.0		4	
6 KUNIYASU HARUAKI (BER)	006 BASSAI DAI	7.8	(8.4)	(7.4)		7.4		7.8		23.0						23.0		2	

## R1 G4/4 (6) Tatami 4 09:25

Teilnehmer	Kata	1T	1A	2T	2A	3T	3A	4T	4A	5T	5A	6T	6A	7T	7A	TEC	ATH	Extr	GesamRang
1 MEIER MIGUEL (NRW)	012 ENPI	(7.2)	7.2	7.2		(7.4)		7.4		21.8						21.8		2	
2 PFANNENSTIEL ASIM (BRE)	041 KANKU SHO	6.8	6.8	(6.6)		(7.6)		7.0		20.6						20.6		3	
3 SEISE FABIAN (THÜ)	006 BASSAI DAI	(7.0)	6.6	(6.2)		7.0		6.6		20.2						20.2		4	
4 BÖHM MIKA (RPF)	083 SEIPAI	(6.6)	(7.0)	6.6		6.8		6.8		20.2						20.2		5	
5 LÜNEBURG LINUS (HBG)	006 BASSAI DAI	6.2	(5.4)	5.8		6.0		(6.4)		18.0						18.0		6	
6 STAPEL DAVID (HES)	041 KANKU SHO	(7.4)	7.6	7.6		8.0		(8.4)		23.2						23.2		1	

## R2-G1

Teilnehmer	Kata	1T	1A	2T	2A	3T	3A	4T	4A	5T	5A	6T	6A	7T	7A	TEC	ATH	Extr	GesamRang
1 REIM NICO (THÜ)	021 GOJUSHIHO SHO	(6.8)	(7.8)	7.4		7.2		7.2		21.8						21.8		6	
2 JAHNSMÜLLER ADRIAN (SAH)	008 CHATANYARA KUSHANKU	(7.6)	(7.2)	7.6		7.4		7.4		22.4						22.4		5	
3 KUMPFERT LUKAS (NRW)	021 GOJUSHIHO SHO	7.0	7.0	7.0		(7.6)		(6.6)		21.0						21.0		7	
4 HORN DOMINIK (BER)	036 JION	6.6	(7.2)	7.2		7.0		(6.4)		20.8						20.8		8	
5 MINOR DANIEL (BAY)	015 GANKAKU	(8.6)	(7.8)	8.0		8.4		8.4		24.8						24.8		2	
6 ALBIEN ALEXANDER (BRE)	078 SANSI	(8.8)	(8.2)	8.4		8.2		8.8		25.4						25.4		1	
7 STENSCHKE MALCOLM (BAY)	015 GANKAKU	(7.4)	7.4	(8.2)		8.0		7.8		23.2						23.2		4	
8 KÖCHER MIKA (SAA)	021 GOJUSHIHO SHO	(8.0)	(7.2)	7.8		7.8		8.0		23.6						23.6		3	

## R2-G2

Teilnehmer	Kata	1T	1A	2T	2A	3T	3A	4T	4A	5T	5A	6T	6A	7T	7A	TEC	ATH	Extr	GesamRang
1 KUNIYASU HARUAKI (BER)	041 KANKU SHO	(7.6)	7.6	(7.2)		7.4		7.6		22.6						22.6		5	
2 MEIER MIGUEL (NRW)	041 KANKU SHO	(7.2)	(8.8)	7.4		7.8		8.0		23.2						23.2		4	
3 STAPEL DAVID (HES)	020 GOJUSHIHO DAI	(8.2)	(9.2)	8.8		8.6		9.0		26.4						26.4		1	
4 SEISE FABIAN (THÜ)	036 JION	7.4	(8.0)	(7.0)		7.0		7.2		21.6						21.6		8	
5 MOHR JAN (BAY)	040 KANKU DAI	(7.0)	(7.8)	7.6		7.6		7.0		22.2						22.2		6	
6 SPIES MAARTEN (HES)	012 ENPI	7.4	7.6	(7.8)		7.0		(6.6)		22.0						22.0		7	
7 GRÖPPER LEON (NRW)	006 BASSAI DAI	7.8	(8.2)	8.0		8.0		(7.6)		23.8						23.8		3	
8 PFANNENSTIEL ASIM (BRE)	078 SANSI	8.0	8.6	(7.2)		(8.8)		8.8		25.4						25.4		2	

## R3-G1

Teilnehmer	Kata	1T	1A	2T	2A	3T	3A	4T	4A	5T	5A	6T	6A	7T	7A	TEC	ATH	Extr	GesamRang
1 KÖCHER MIKA (SAA)	041 KANKU SHO	(7.8)	7.6	(6.8)		7.4		7.6		22.6						22.6		3	
2 ALBIEN ALEXANDER (BRE)	020 GOJUSHIHO DAI	8.2	8.2	(7.6)		8.0		(8.4)		24.4						24.4		2	
3 STENSCHKE MALCOLM (BAY)	021 GOJUSHIHO SHO	(7.6)	7.2	7.4		(7.0)		7.4		22.0						22.0		4	
4 MINOR DANIEL (BAY)	021 GOJUSHIHO SHO	8.6	(8.8)	(8.2)		8.4		8.6		25.6						25.6		1	

## R3-G2

	Teilnehmer	Kata	1 T	1 A	2 T	2 A	3 T	3 A	4 T	4 A	5 T	5 A	6 T	6 A	7 T	7 A	TEC	ATH	Extra	Gesam	Rang
1	GRÖPPER LEON (NRW)	012 ENPI	7.6	(7.8)			(7.4)		7.8		7.8						23.2			23.2	3
2	MEIER MIGUEL (NRW)	021 GOJUSHIHO SHO	(6.8)		7.2		(8.2)		8.2		7.4						22.8			22.8	4
3	STAPEL DAVID (HES)	021 GOJUSHIHO SHO	9.0		(8.4)		8.8		(9.2)		8.4						26.2			26.2	1
4	PFANNENSTIEL ASIM (BRE)	021 GOJUSHIHO SHO	(8.6)		8.6		8.4		8.6		(8.0)						25.6			25.6	2

#### R4 Bronze Medal Match 1

	Teilnehmer	Kata	1 T	1 A	2 T	2 A	3 T	3 A	4 T	4 A	5 T	5 A	6 T	6 A	7 T	7 A	TEC	ATH	Extra	Gesam	Rang
1	ALBIEN ALEXANDER (BRE)	078 SANSAI	(8.2)		8.2		(8.6)		(8.4)		8.2		(8.0)		8.4		24.8			24.8	1
2	GRÖPPER LEON (NRW)	036 JION	(7.8)		7.8		(8.2)		(8.0)		8.0		(7.6)		8.0		23.8			23.8	2





#### R4 Bronze Medal Match 2

	Teilnehmer	Kata	1 T	1 A	2 T	2 A	3 T	3 A	4 T	4 A	5 T	5 A	6 T	6 A	7 T	7 A	TEC	ATH	Extra	Gesam	Rang
1	PFANNENSTIEL ASIM (BRE)	078 SANSAI	(8.0)		(7.8)		7.8		7.8		7.8		(7.2)		(7.6)		23.4			23.4	1
2	KÖCHER MIKA (SAA)	012 ENPI	7.6		7.6		(8.2)		(8.2)		(7.4)		(7.4)		8.2		23.4			23.4	2

#### R4 Gold Medal Match

	Teilnehmer	Kata	1 T	1 A	2 T	2 A	3 T	3 A	4 T	4 A	5 T	5 A	6 T	6 A	7 T	7 A	TEC	ATH	Extra	Gesam	Rang
1	STAPEL DAVID (HES)	078 SANSAI	(7.6)		(7.8)		7.8		8.2		(8.4)		8.0		(8.6)		24.0			24.0	2
2	MINOR DANIEL (BAY)	099 UNSU	(8.4)		(8.2)		8.4		8.4		(8.6)		(8.2)		8.4		25.2			25.2	1

#### Results

1	MINOR DANIEL	TUS FEUCHTWANGEN ABT. KARATE		GERMANY
2	STAPEL DAVID	TSG 1885 NEU ISENBURG E.V.		GERMANY
3	ALBIEN ALEXANDER	TUS HUCHTING V. 1904 E. V. - ABT. KARATE		GERMANY
3	PFANNENSTIEL ASIM	SFL - BREMERHAVEN E.V.		GERMANY

**R1 G1/4 (8) Tatami 1 09:00**

Teilnehmer	Kata	1 T	1 A	2 T	2 A	3 T	3 A	4 T	4 A	5 T	5 A	6 T	6 A	7 T	7 A	TEC	ATH	Extra	GesamRang	
1	GNERLICH MARLENE (BRA)																			
2	SCHAEER SOPHIE (SH)																			
3	KESTANE TALIA (NRW)	006 BASSAI DAI	(6.8)	7.6		7.6		(7.9)		7.2							22.4			22.4 4
4	BASLER LAURA (BW)	036 JION	(7.4)	(6.8)		7.2		7.3		6.8							21.3			21.3 6
5	DREWES LEYLA-ORCHIDEA (NS)	041 KANKU SHO	7.8	(7.4)		7.4		(8.1)		8.0							23.2			23.2 2
6	LEGLER JULIA (BAY)	020 GOJUSHIHO DAI	8.2	(8.4)		(8.0)		8.3		8.2							24.7			24.7 1
7	POH NADINE SOPHIE (RPF)	068 PAPUREN	(8.0)	(7.6)		7.6		7.6		7.6							22.8			22.8 3
8	HABERLAND PIA (THÜ)	006 BASSAI DAI	7.6	(8.0)		7.2		7.4		(7.0)							22.2			22.2 5

**R1 G2/4 (7) Tatami 2 09:00**

Teilnehmer	Kata	1 T	1 A	2 T	2 A	3 T	3 A	4 T	4 A	5 T	5 A	6 T	6 A	7 T	7 A	TEC	ATH	Extra	GesamRang	
1	GUTZEIT NELLY (BW)	021 GOJUSHIHO SHO	(7.8)	7.6		7.4		(7.2)		7.4							22.4			22.4 3
2	DALINGE LILOU (HBG)	006 BASSAI DAI	(5.8)	(6.8)		6.4		6.6		6.2							19.2			19.2 6
3	SCHUBERT ALICIA (SAC)	070 PINAN SHODAN	(6.8)	6.6		6.6		6.0		(5.6)							19.2			19.2 7
4	STEVENS CLAIRE (HES)	012 ENPI	7.6	(8.0)		7.6		(6.8)		7.2							22.4			22.4 4
5	TAHIRI NADA (NRW)	036 JION	7.6	7.4		7.2		(7.0)		(8.4)							22.2			22.2 5
6	KOLLMANN MARA (SAH)	001 ANAN	8.0	(8.4)		8.0		(7.6)		8.2							24.2			24.2 2
7	SIEBERT RONJA (BAY)	067 PAIKU	8.4	8.6		(8.2)		8.4		(8.8)							25.4			25.4 1

**R1 G3/4 (7) Tatami 3 09:00**

Teilnehmer	Kata	1 T	1 A	2 T	2 A	3 T	3 A	4 T	4 A	5 T	5 A	6 T	6 A	7 T	7 A	TEC	ATH	Extra	GesamRang	
1	SORA LIANE (BW)	036 JION	(6.8)	7.0		6.8		7.2		(7.4)							21.0			21.0 7
2	STROH VENERA (RPF)	083 SEIPAI	7.4	(6.8)		7.6		7.8		(8.0)							22.8			22.8 5
3	SCHMIDT KLARA JOHANNA (HBG)	041 KANKU SHO	(8.2)	7.6		8.0		(7.4)		7.8							23.4			23.4 3
4	REICHEL ANNA (HES)	041 KANKU SHO	(7.8)	7.4		(6.6)		7.0		7.2							21.6			21.6 6
5	GEBAUER LISA (BAY)	011 CHINTO	(8.6)	(6.8)		8.4		7.2		7.6							23.2			23.2 4
6	KÜSTERS FRIDA (NRW)	036 JION	(9.0)	(7.2)		8.8		8.0		8.4							25.2			25.2 2
7	LÜCK ALYSSA LILLY (BRE)	002 ANAN DAI	8.8	(9.0)		9.0		(8.4)		8.6							26.4			26.4 1

**R1 G4/4 (7) Tatami 4 09:00**

Teilnehmer	Kata	1 T	1 A	2 T	2 A	3 T	3 A	4 T	4 A	5 T	5 A	6 T	6 A	7 T	7 A	TEC	ATH	Extra	GesamRang	
1	WINSTEL NELE (RPF)	012 ENPI	7.4	(6.8)		7.6		(8.0)		7.4							22.4			22.4 3
2	DRISSEN ELSA (THÜ)	036 JION	7.0	7.2		(6.8)		7.4		(7.8)							21.6			21.6 5
3	RIPS MAILIN (NRW)	036 JION	8.4	(7.6)		8.2		(8.6)		8.2							24.8			24.8 1
4	GALLERT LILLI (BW)	036 JION	(6.8)	7.4		7.2		(7.8)		7.0							21.6	0.01		21.61 4
5	BOBBERT AITANA (BAY)	002 ANAN DAI	8.0	8.0		(6.6)		(8.4)		8.4							24.4			24.4 2
6	WEIKERT JOSEPHIN (SAH)	040 KANKU DAI	(5.8)	6.4		6.4		6.2		(6.8)							19.0			19.0 6
7	EBERSBACH RONJA ROMY (SAC)																			

**R2-G1**

Teilnehmer	Kata	1 T	1 A	2 T	2 A	3 T	3 A	4 T	4 A	5 T	5 A	6 T	6 A	7 T	7 A	TEC	ATH	Extra	GesamRang	
1	LEGLER JULIA (BAY)	008 CHATANYARA KUSHANKU	7.8	(7.6)		(8.4)		8.0		8.2							24.0			24.0 1
2	DREWES LEYLA-ORCHIDEA (NS)	020 GOJUSHIHO DAI	7.4	(7.0)		(7.6)		7.2		7.4							22.0			22.0 5
3	KOLLMANN MARA (SAH)	008 CHATANYARA KUSHANKU	(6.6)	(7.4)		7.2		7.0		7.0							21.2			21.2 8
4	POH NADINE SOPHIE (RPF)	002 ANAN DAI	7.0	(6.8)		(7.6)		7.4		7.6							22.0			22.0 6
5	GUTZEIT NELLY (BW)	020 GOJUSHIHO DAI	(7.4)	(8.0)		8.0		7.6		8.0							23.6			23.6 3
6	SIEBERT RONJA (BAY)	001 ANAN	8.0	(7.4)		(8.2)		8.2		7.8							24.0			24.0 2
7	STEVENS CLAIRE (HES)	021 GOJUSHIHO SHO	7.6	(7.8)		7.8		(7.4)		7.4							22.8			22.8 4
8	KESTANE TALIA (NRW)	021 GOJUSHIHO SHO	(7.0)	7.0		(7.6)		7.2		7.0							21.2			21.2 7

**R2-G2**

Teilnehmer	Kata	1 T	1 A	2 T	2 A	3 T	3 A	4 T	4 A	5 T	5 A	6 T	6 A	7 T	7 A	TEC	ATH	Extra	GesamRang	
1	WINSTEL NELE (RPF)	036 JION	7.2	(7.6)		7.4		(7.0)		7.4							22.0			22.0 3
2	KÜSTERS FRIDA (NRW)	021 GOJUSHIHO SHO	(6.6)	6.8		6.8		7.4		(7.6)							21.0			21.0 6
3	RIPS MAILIN (NRW)	012 ENPI	(7.0)	7.2		7.2		(8.0)		7.2							21.6			21.6 4
4	SCHMIDT KLARA JOHANNA (HBG)	021 GOJUSHIHO SHO	6.8	(6.4)		7.4		(7.8)		7.4							21.6			21.6 5
5	GEBAUER LISA (BAY)	048 KUSANKU	(6.4)	6.8		(7.0)		6.6		6.6							20.0			20.0 8
6	BOBBERT AITANA (BAY)	068 PAPUREN	(7.6)	7.8		(8.0)		7.6		8.0							23.4			23.4 2
7	GALLERT LILLI (BW)	027 HEIAN SANDAN	6.6	(7.4)		7.4		(6.4)		6.8							20.8			20.8 7
8	LÜCK ALYSSA LILLY (BRE)	068 PAPUREN	8.0	(7.6)		7.8		(8.2)		7.8							23.6			23.6 1



Deutsche Meisterschaft der Schüler 2021 - 2021-09-19  
Schüler A Kata Einzel Mädchen



## Tie Match 1-3

Teilnehmer	Kata	1T	1A	2T	2A	3T	3A	4T	4A	5T	5A	6T	6A	7T	7A	TEC	ATH	Extra	GesamRang
1 GALLERT LILLI (BW)	040 KANKU DAI	(6.8)		6.8		6.8		(7.4)		7.4						21.0			21.0 1
2 DRISSEN ELSA (THÜ)	021 GOJUSHIHO SHO	(7.2)		7.2		(6.4)		6.8		6.8						20.8			20.8 2

## R3-G1

Teilnehmer	Kata	1T	1A	2T	2A	3T	3A	4T	4A	5T	5A	6T	6A	7T	7A	TEC	ATH	Extra	GesamRang
1 STEVENS CLAIRE (HES)	099 UNSU	8.0		(7.8)		7.8		7.8		(8.2)						23.6			23.6 4
2 SIEBERT RONJA (BAY)	002 ANAN DAI	(8.4)		(8.2)		8.4		8.4		8.4						25.2			25.2 2
3 GUTZEIT NELLY (BW)	041 KANKU SHO	(7.8)		(8.0)		8.0		8.0		8.0						24.0			24.0 3
4 LEGLER JULIA (BAY)	068 PAPUREN	(8.6)		(8.0)		8.2		8.6		8.6						25.4			25.4 1

## R3-G2

Teilnehmer	Kata	1T	1A	2T	2A	3T	3A	4T	4A	5T	5A	6T	6A	7T	7A	TEC	ATH	Extra	GesamRang
1 BOBBERT AITANA (BAY)	001 ANAN	7.8		(8.4)		(7.2)		7.2		7.4						22.4			22.4 3
2 WINSTEL NELE (RPF)	041 KANKU SHO	7.6		7.2		7.6		(7.8)		(6.8)						22.4			22.4 4
3 LÜCK ALYSSA_LILLY (BRE)	008 CHATANYARA KUSHANKU	(8.2)		(8.0)		8.2		8.0		8.0						24.2			24.2 1
4 RIPS MAILIN (NRW)	035 JIIN	8.0		(8.2)		8.0		8.2		(7.8)						24.2			24.2 2

## R4 Bronze Medal Match 1

Teilnehmer	Kata	1T	1A	2T	2A	3T	3A	4T	4A	5T	5A	6T	6A	7T	7A	TEC	ATH	Extra	GesamRang
1 SIEBERT RONJA (BAY)	064 OHAN DAI	(8.2)		(8.2)		(8.2)		(8.2)		8.2		8.2		8.2		24.6			24.6 1
2 BOBBERT AITANA (BAY)	008 CHATANYARA KUSHANKU	(8.0)		7.8		(7.6)		8.0		(8.6)		(7.6)		7.8		23.6			23.6 2

## R4 Bronze Medal Match 2

Teilnehmer	Kata	1T	1A	2T	2A	3T	3A	4T	4A	5T	5A	6T	6A	7T	7A	TEC	ATH	Extra	GesamRang
1 GUTZEIT NELLY (BW)	020 GOJUSHIHO DAI	(8.4)		(8.0)		8.0		(7.8)		8.0		(7.8)		8.0		24.0			24.0 2
2 RIPS MAILIN (NRW)	036 JION	(8.2)		8.2		(8.4)		8.2		(7.8)		8.2		(8.4)		24.6			24.6 1

## R4 Gold Medal Match

Teilnehmer	Kata	1T	1A	2T	2A	3T	3A	4T	4A	5T	5A	6T	6A	7T	7A	TEC	ATH	Extra	GesamRang
1 LEGLER JULIA (BAY)	009 CHIBANA NO KUSHANKU	(8.4)		8.4		8.4		(8.6)		8.4		(8.2)		(8.6)		25.2			25.2 1
2 LÜCK ALYSSA_LILLY (BRE)	002 ANAN DAI	(8.2)		(8.0)		(8.6)		8.2		8.2		(8.4)		8.4		24.8			24.8 2

## Results

1	LEGLER JULIA	ASIA SPORTS WALDKRAIBURG E.V.		GERMANY
2	LÜCK ALYSSA LILLY	KARATE SCHULE NIPPON BREMERHAVEN E.V.		GERMANY
3	SIEBERT RONJA	OKINAWA KARATE TUS ALZTAL GARCHING		GERMANY
3	RIPS MAILIN	KAITEN BEDBURG-HAU E.V.		GERMANY

# Schüler A Kumite Einzel Jungen -38 kg

Deutsche Meisterschaft der Schüler 2021, Horst-Korber-Sportzentrum, Am Glockenturm 3-5, 14053 Berlin, GER

Tatami  
4 13:10

Pool  
1/1

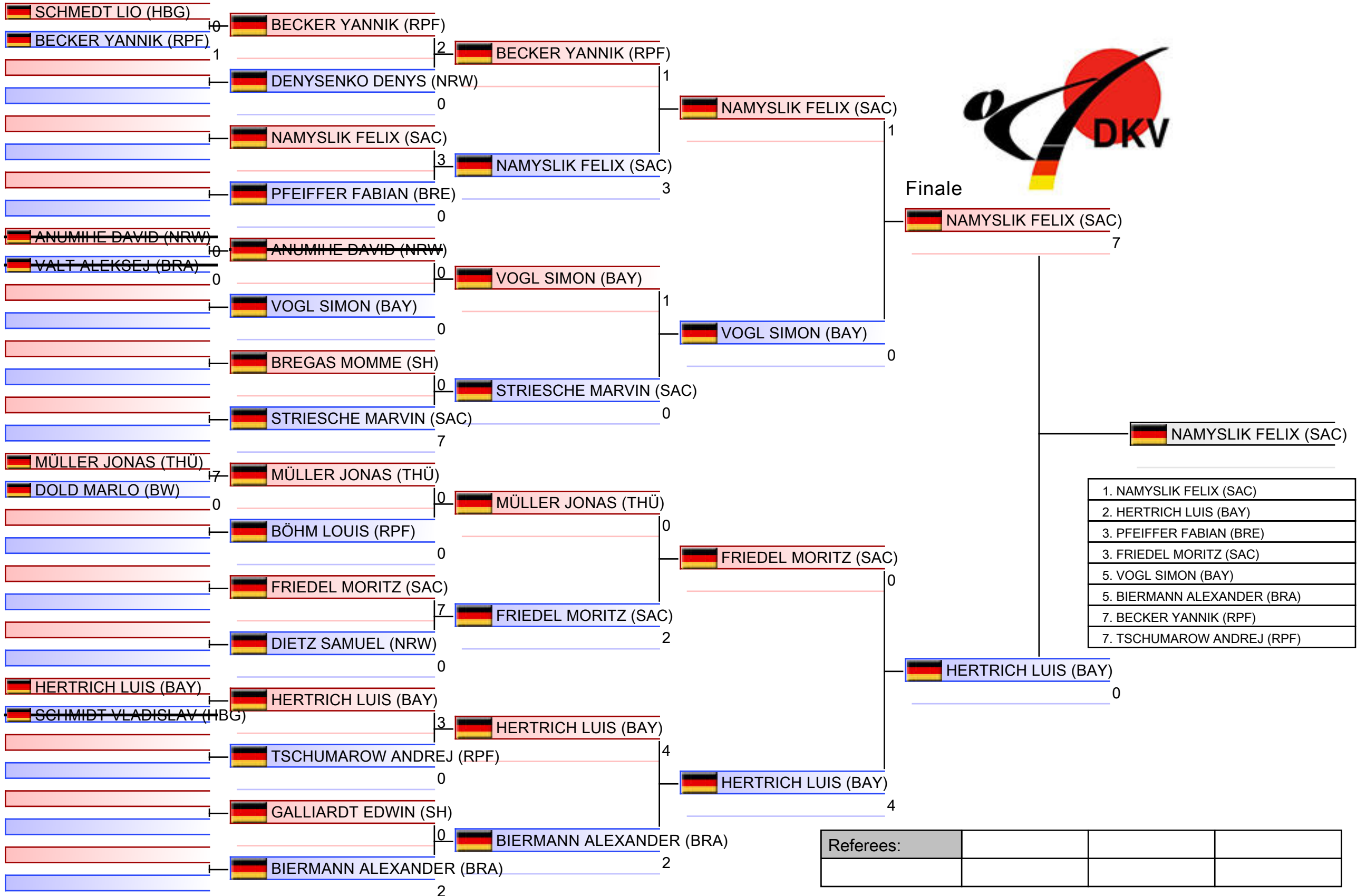

# Schüler A Kumite Einzel Jungen -38 kg

Deutsche Meisterschaft der Schüler 2021

Tatami  
4 14:20

Pool  
1

(c)sportdata GmbH & Co KG 2000-2021(2021-09-19 22:28) -WKF Approved- v 9.8.8 build 1 (2021-07-19) Lizenz: SDIL Sportdata Internal License 2021 (expire 2021-12-31)

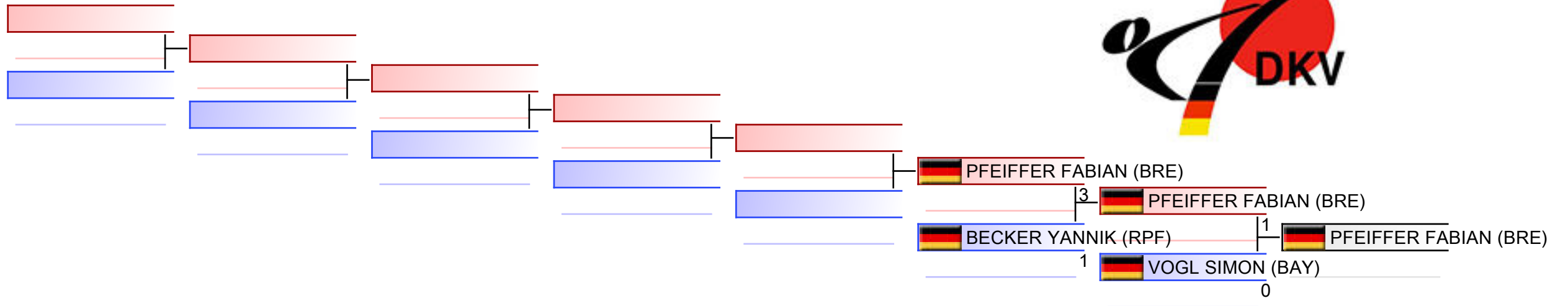

## TROSTRUNDE: (1)

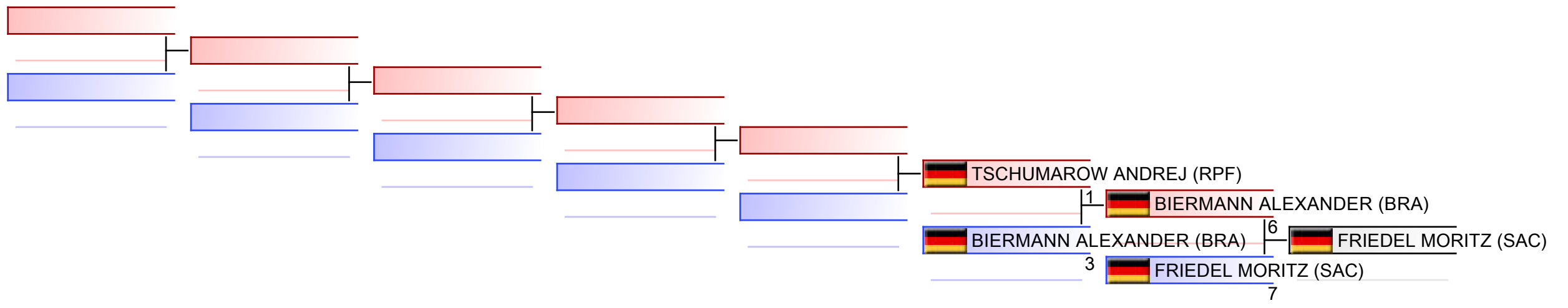

Referees:							
-----------	--	--	--	--	--	--	--



# Schüler A Kumite Einzel Jungen -44 kg

Deutsche Meisterschaft der Schüler 2021, Horst-Korber-Sportzentrum, Am Glockenturm 3-5, 14053 Berlin, GER

Tatami  
6 13:20

Pool  
1/2

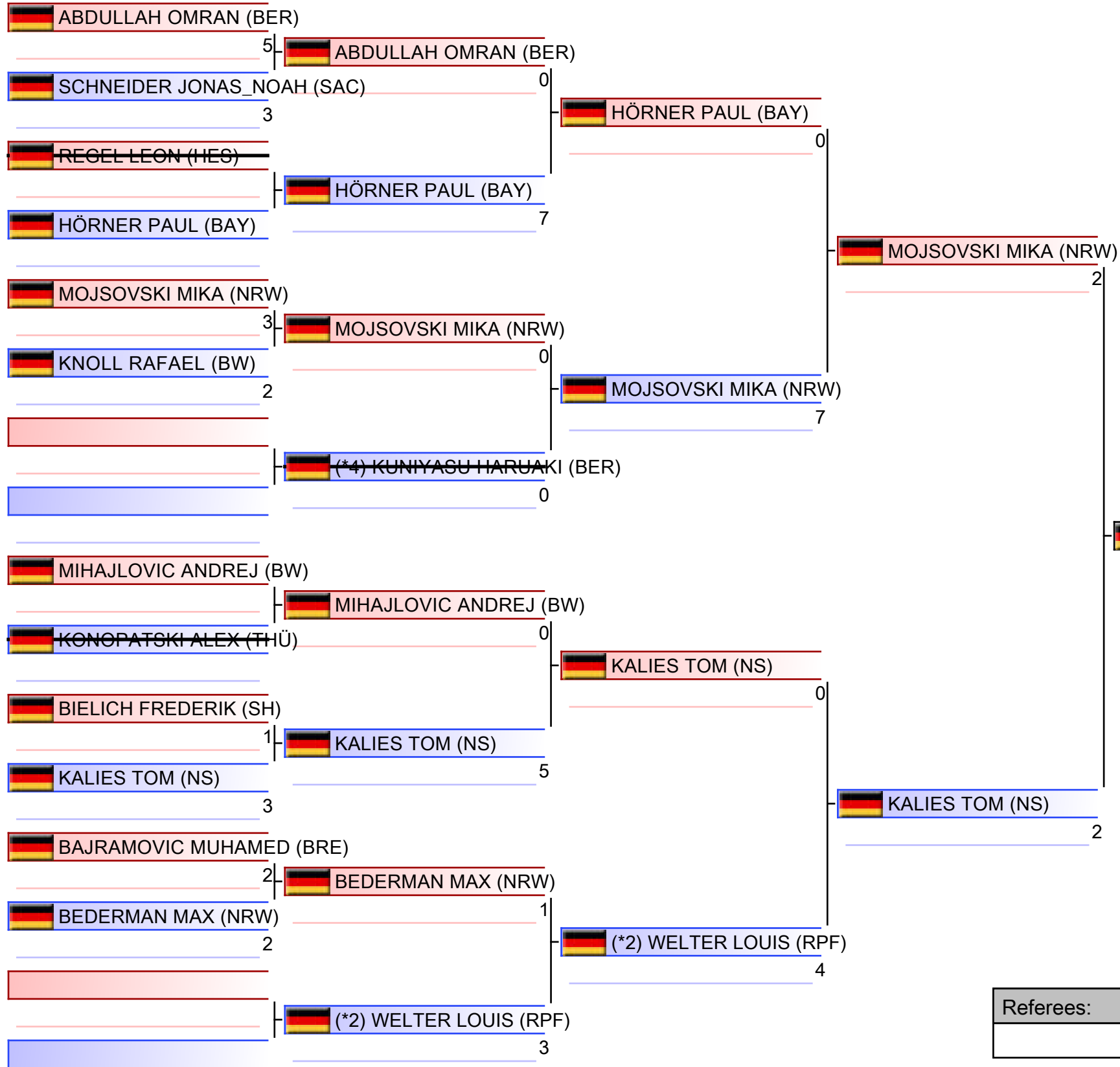

1. ALTKEMPER SAM (NRW)
2. KALIES TOM (NS)
3. BECKER FINLEY (RPF)
3. MOJSOVSKI MIKA (NRW)
5. CHATAEV_ISLAM ADAM (SH)
5. WELTER LOUIS (RPF)
7. JÄGER MORITZ (SAC)
7. BIELICH FREDERIK (SH)

\*Gesetzt

Referees:			

# Schüler A Kumite Einzel Jungen -44 kg

Deutsche Meisterschaft der Schüler 2021, Horst-Korber-Sportzentrum, Am Glockenturm 3-5, 14053 Berlin, GER

Tatami  
6 14:05

Pool  
2/2

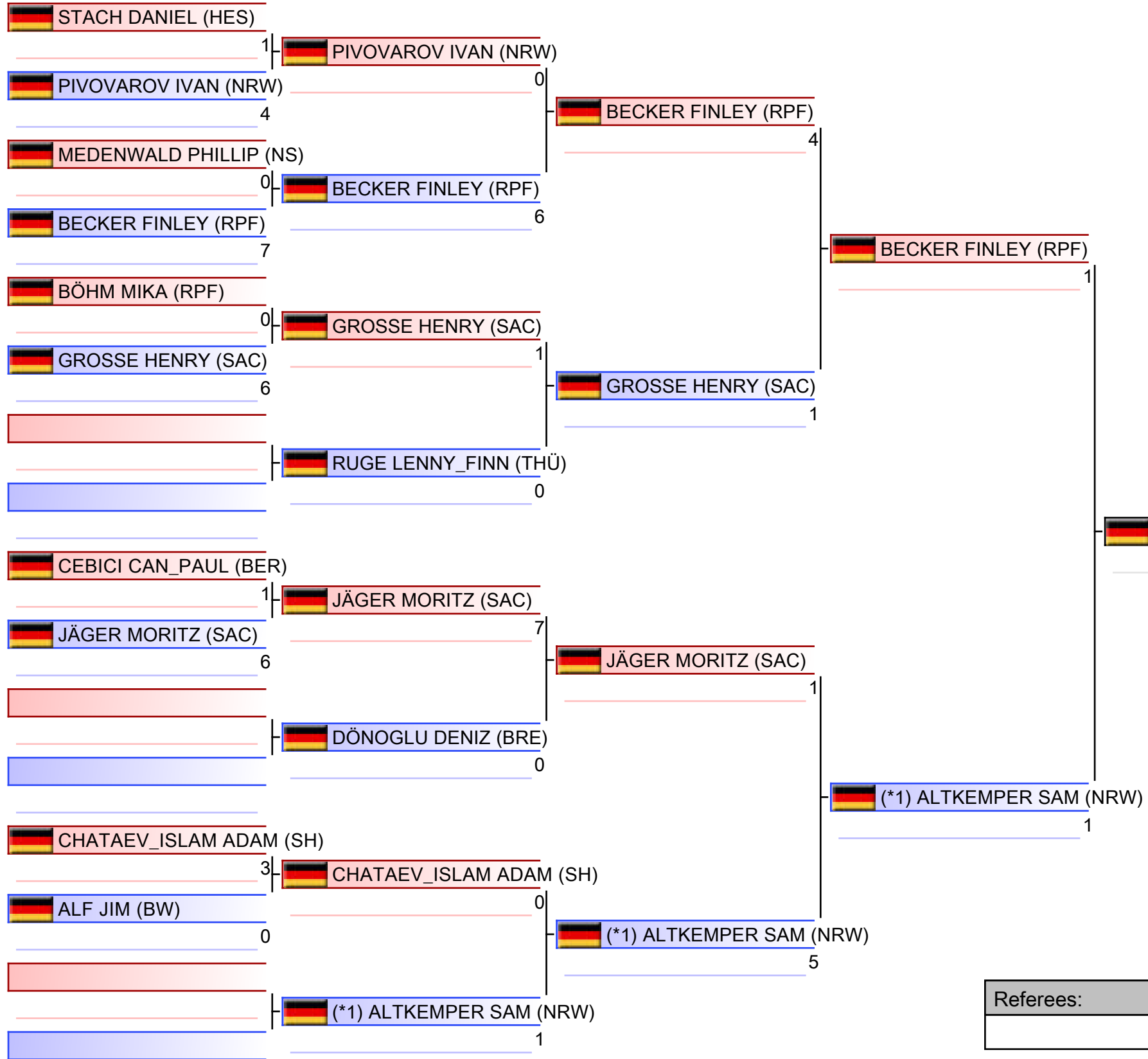

1. ALTKEMPER SAM (NRW)
2. KALIES TOM (NS)
3. BECKER FINLEY (RPF)
3. MOJSOVSKI MIKA (NRW)
5. CHATAEV_ISLAM ADAM (SH)
5. WELTER LOUIS (RPF)
7. JÄGER MORITZ (SAC)
7. BIELICH FREDERIK (SH)

\*Gesetzt

Referees:			

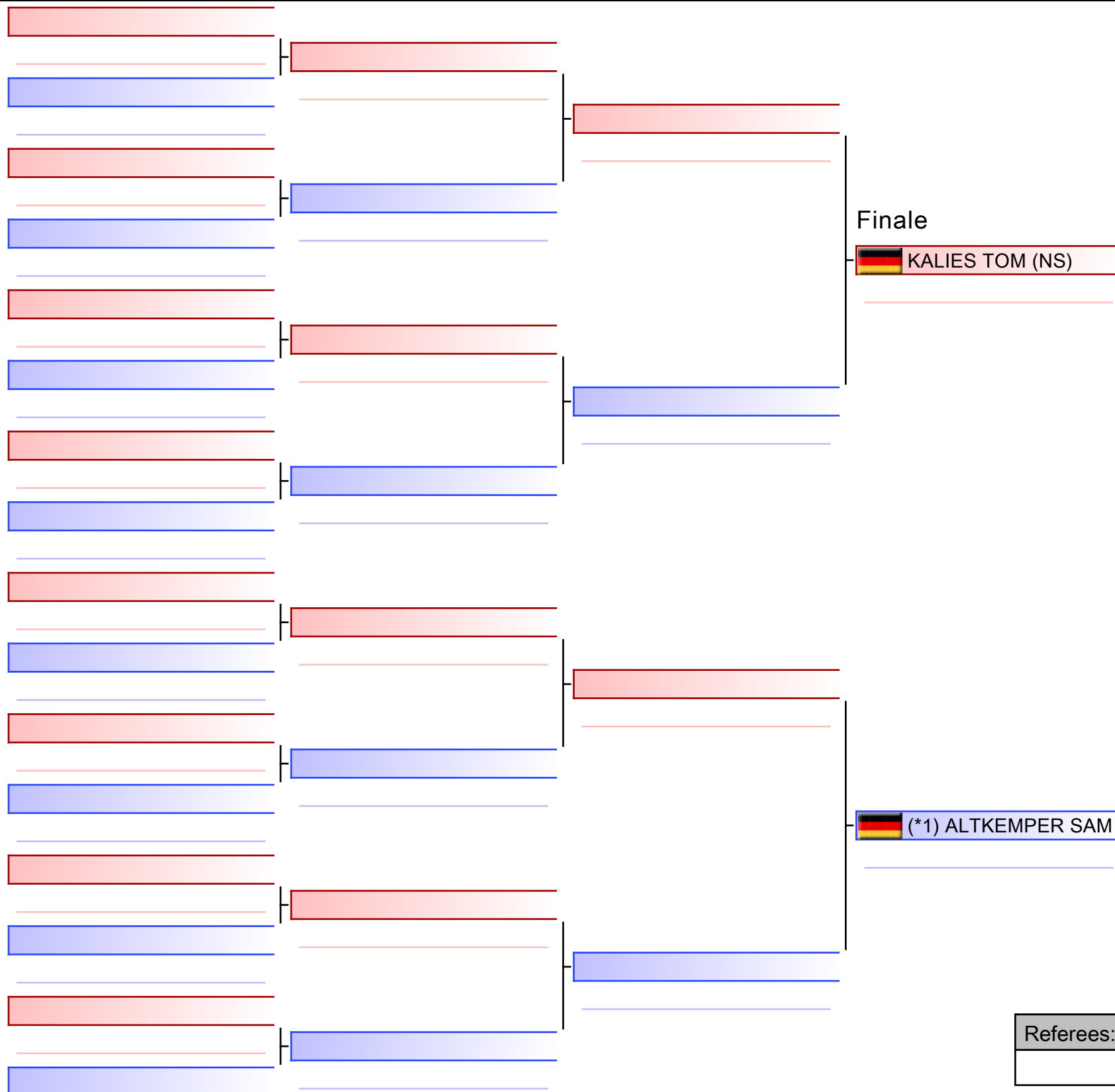

**Finale**

**KALIES TOM (NS)**

1

**(\*1) ALTKEMPER SAM (NRW)**

**(\*1) ALTKEMPER SAM (NRW)**

2

1. ALTKEMPER SAM (NRW)
2. KALIES TOM (NS)
3. BECKER FINLEY (RPF)
3. MOJSOVSKI MIKA (NRW)
5. CHATAEV_ISLAM ADAM (SH)
5. WELTER LOUIS (RPF)
7. JÄGER MORITZ (SAC)
7. BIELICH FREDERIK (SH)

\*Gesetzt

Referees:			

# Schüler A Kumite Einzel Jungen -44 kg

Deutsche Meisterschaft der Schüler 2021

Tatami  
6 14:55

Pool  
1,2

(c)sportdata GmbH & Co KG 2000-2021(2021-09-19 22:28) -WKF Approved- v 9.8.8 build 1 (2021-07-19) Lizenz: SDIL Sportdata Internal License 2021 (expire 2021-12-31)

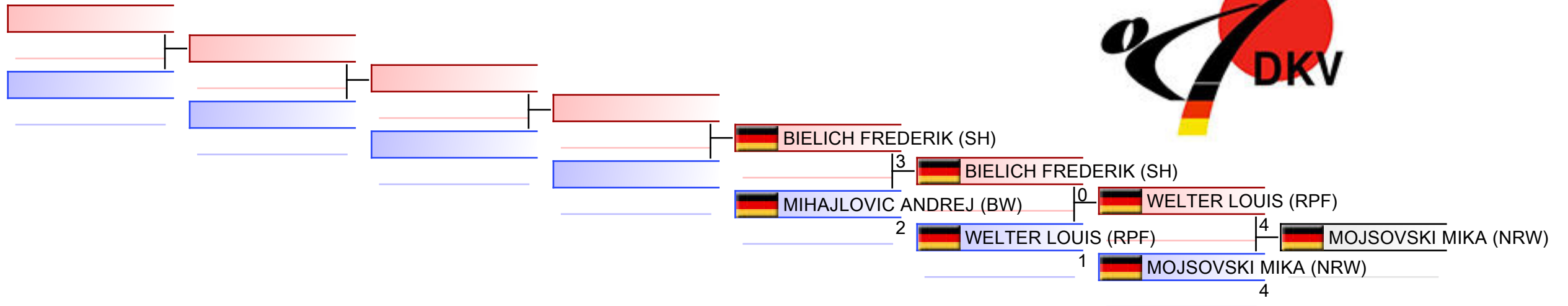

## TROSTRUNDE: (1,2)

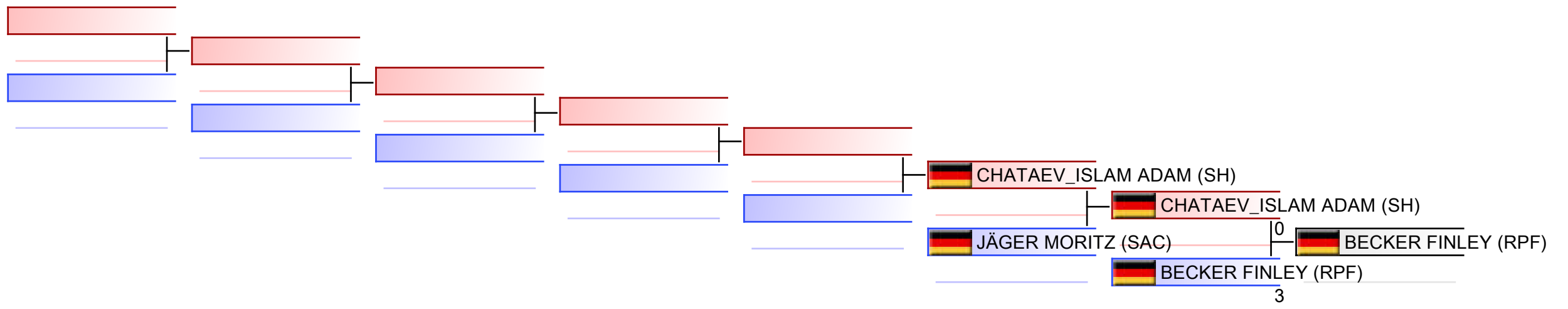

Referees:							
-----------	--	--	--	--	--	--	--

# Schüler A Kumite Einzel Jungen -44 kg

Deutsche Meisterschaft der Schüler 2021

Tatami  
6 14:55

Pool  
1

(c)sportdata GmbH & Co KG 2000-2021(2021-09-19 22:28) -WKF Approved- v 9.8.8 build 1 (2021-07-19) Lizenz: SDIL Sportdata Internal License 2021 (expire 2021-12-31)

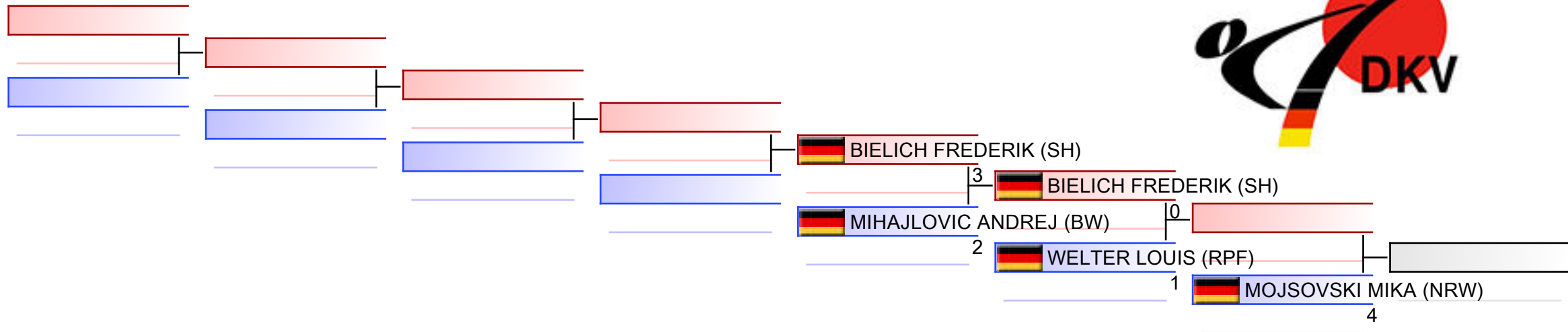

## TROSTRUNDE: (1)

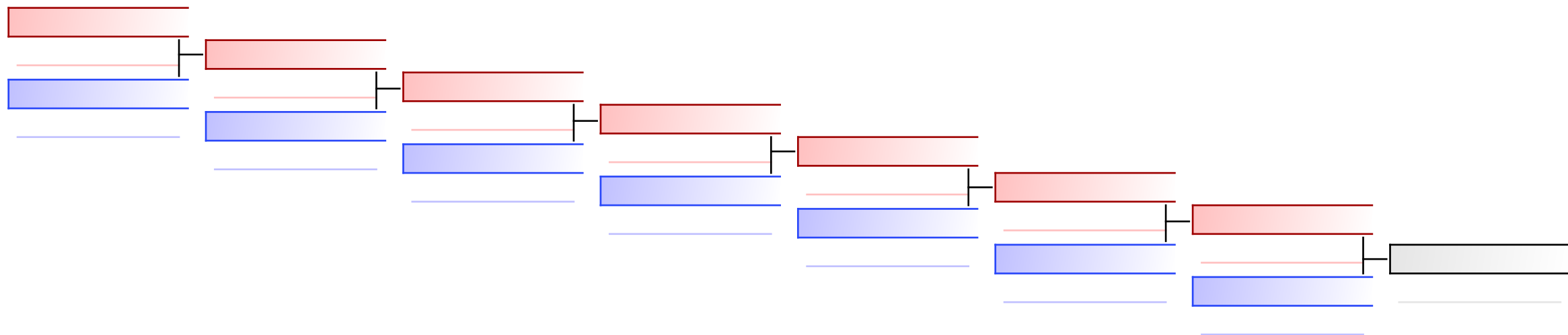

Referees:							
-----------	--	--	--	--	--	--	--

# Schüler A Kumite Einzel Jungen -44 kg

Deutsche Meisterschaft der Schüler 2021

Tatami  
6 15:05

Pool  
2

(c)sportdata GmbH & Co KG 2000-2021(2021-09-19 22:28) -WKF Approved- v 9.8.8 build 1 (2021-07-19) Lizenz: SDIL Sportdata Internal License 2021 (expire 2021-12-31)

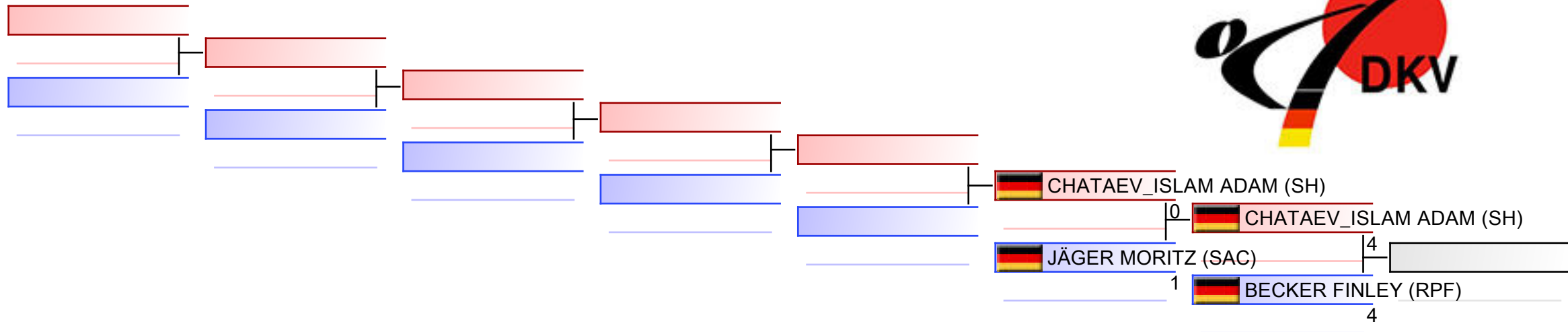

## TROSTRUNDE: (2)

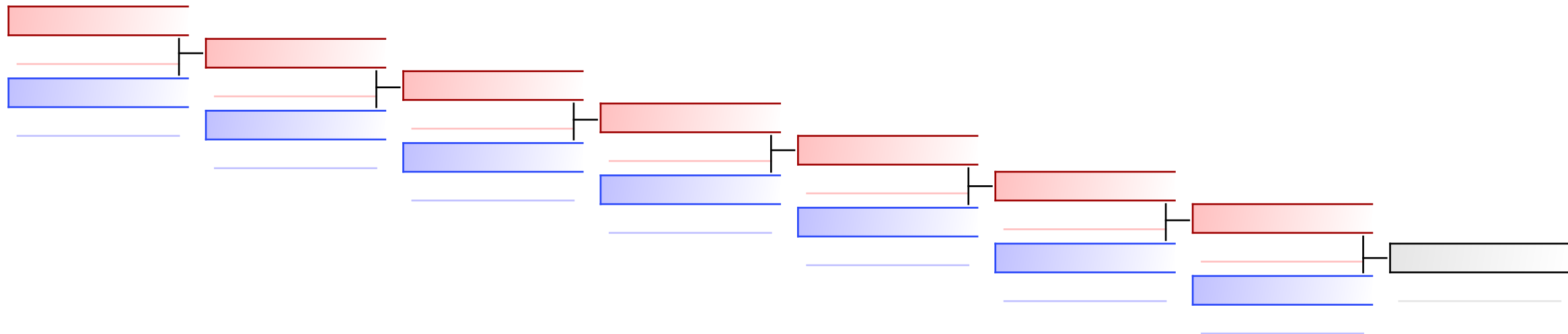

Referees:							
-----------	--	--	--	--	--	--	--

# Schüler A Kumite Einzel Jungen -49 kg

Deutsche Meisterschaft der Schüler 2021, Horst-Korber-Sportzentrum, Am Glockenturm 3-5, 14053 Berlin, GER

Tatami  
5 14:05

Pool  
1/1

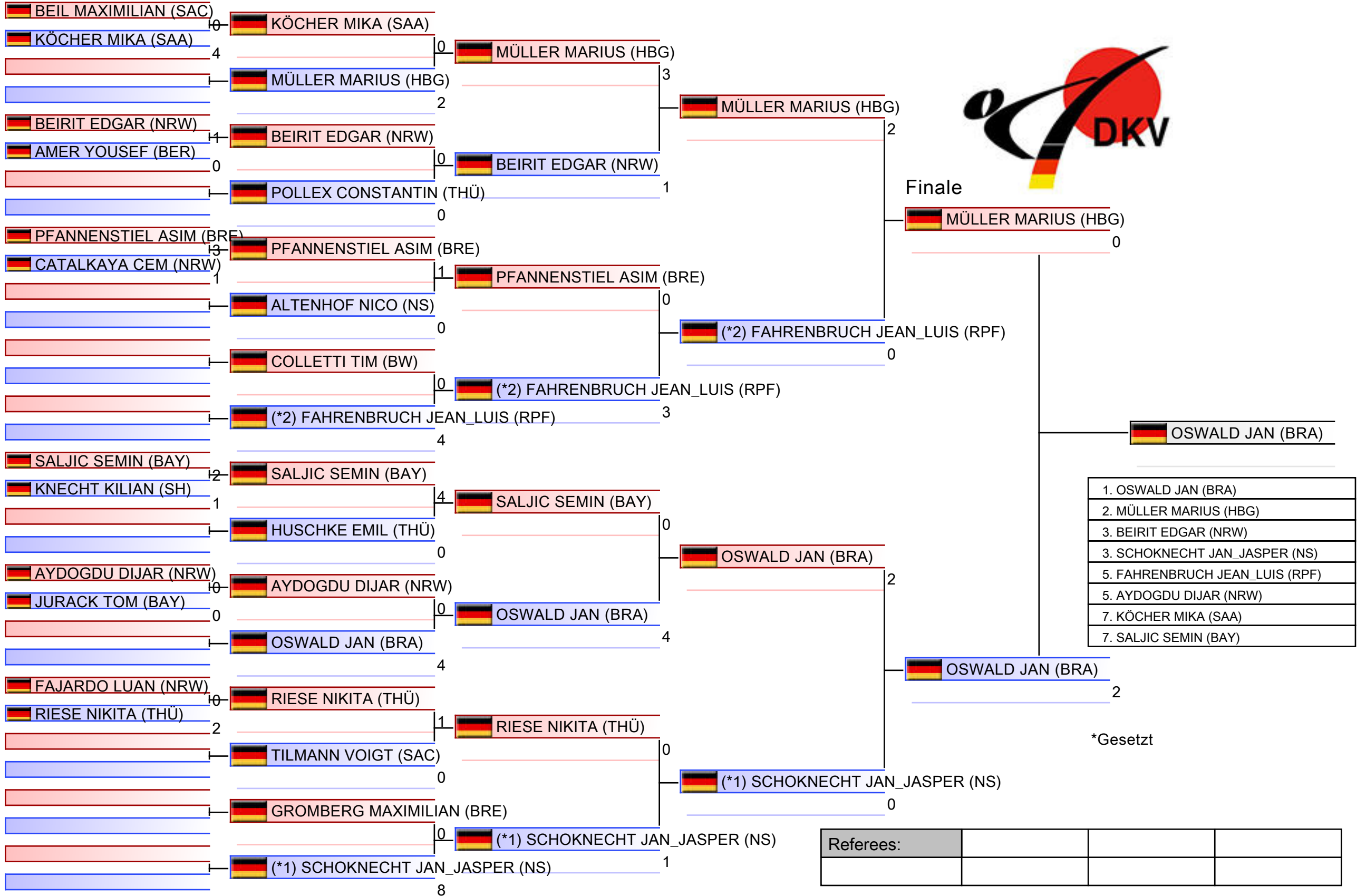

# Schüler A Kumite Einzel Jungen -49 kg

Deutsche Meisterschaft der Schüler 2021

Tatami  
5 15:20

Pool  
1

(c)sportdata GmbH & Co KG 2000-2021(2021-09-19 22:28) -WKF Approved- v 9.8.8 build 1 (2021-07-19) Lizenz: SDIL Sportdata Internal License 2021 (expire 2021-12-31)

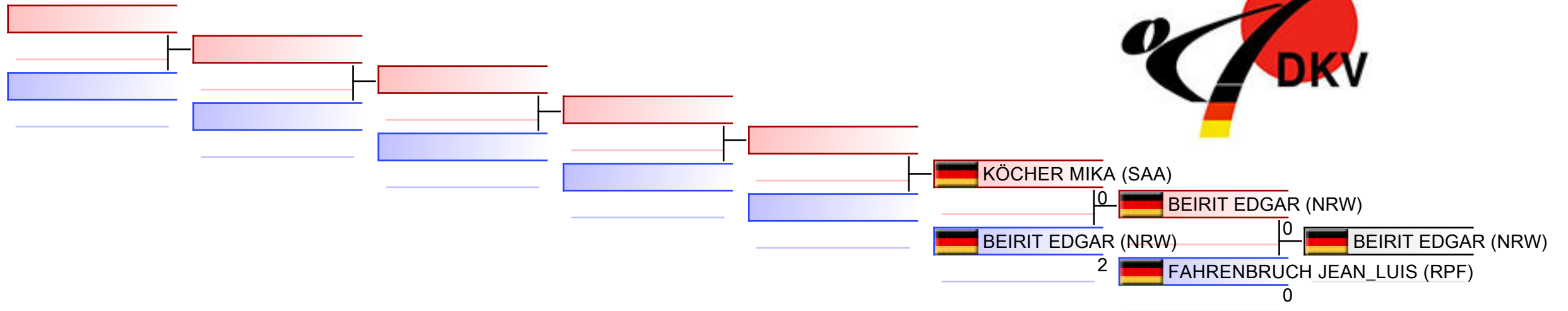

## TROSTRUNDE: (1)

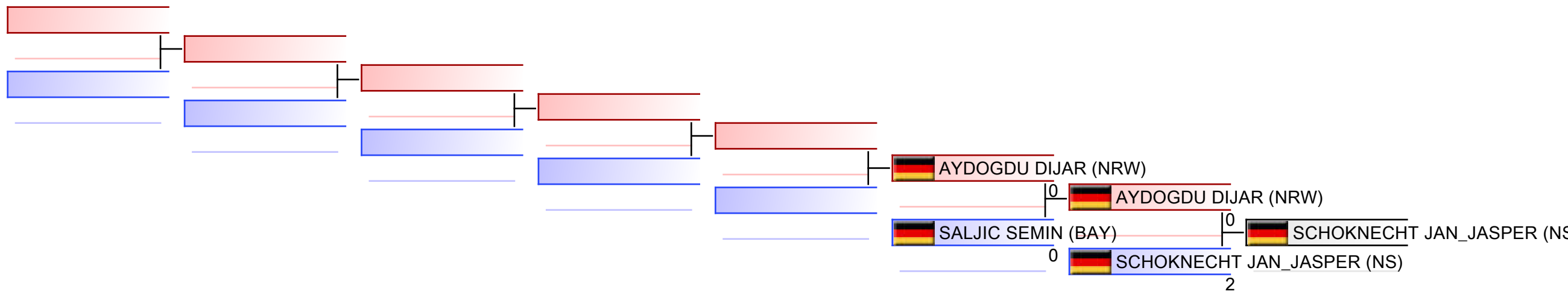

Referees:							
-----------	--	--	--	--	--	--	--



# Schüler A Kumite Einzel Jungen +49 kg

Deutsche Meisterschaft der Schüler 2021, Horst-Korber-Sportzentrum, Am Glockenturm 3-5, 14053 Berlin, GER

Tatami  
5 13:20

Pool  
1/2

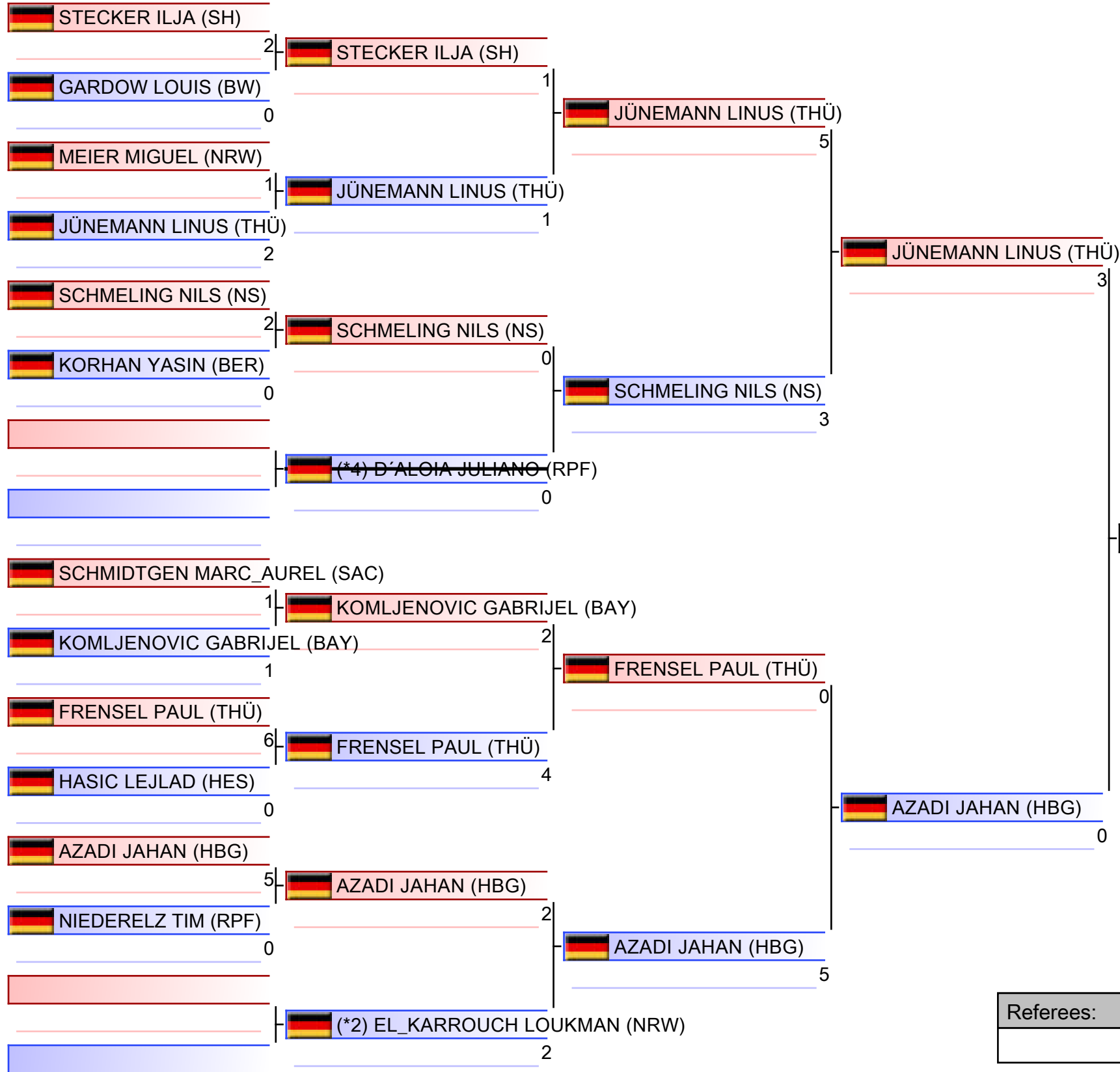

1. BRÜCKNER MALTE (SAH)
2. JÜNEMANN LINUS (THÜ)
3. AZADI JAHAN (HBG)
3. HERZOG WILHELM (SAC)
5. SCHMELING NILS (NS)
5. SCHWARZBECK NICK_MARLO (BW)
7. MEIER MIGUEL (NRW)
7. KURZ PHIL (RPF)

\*Gesetzt

Referees:			

# Schüler A Kumite Einzel Jungen +49 kg

Deutsche Meisterschaft der Schüler 2021, Horst-Korber-Sportzentrum, Am Glockenturm 3-5, 14053 Berlin, GER

Tatami  
4 14:45

Pool  
2/2

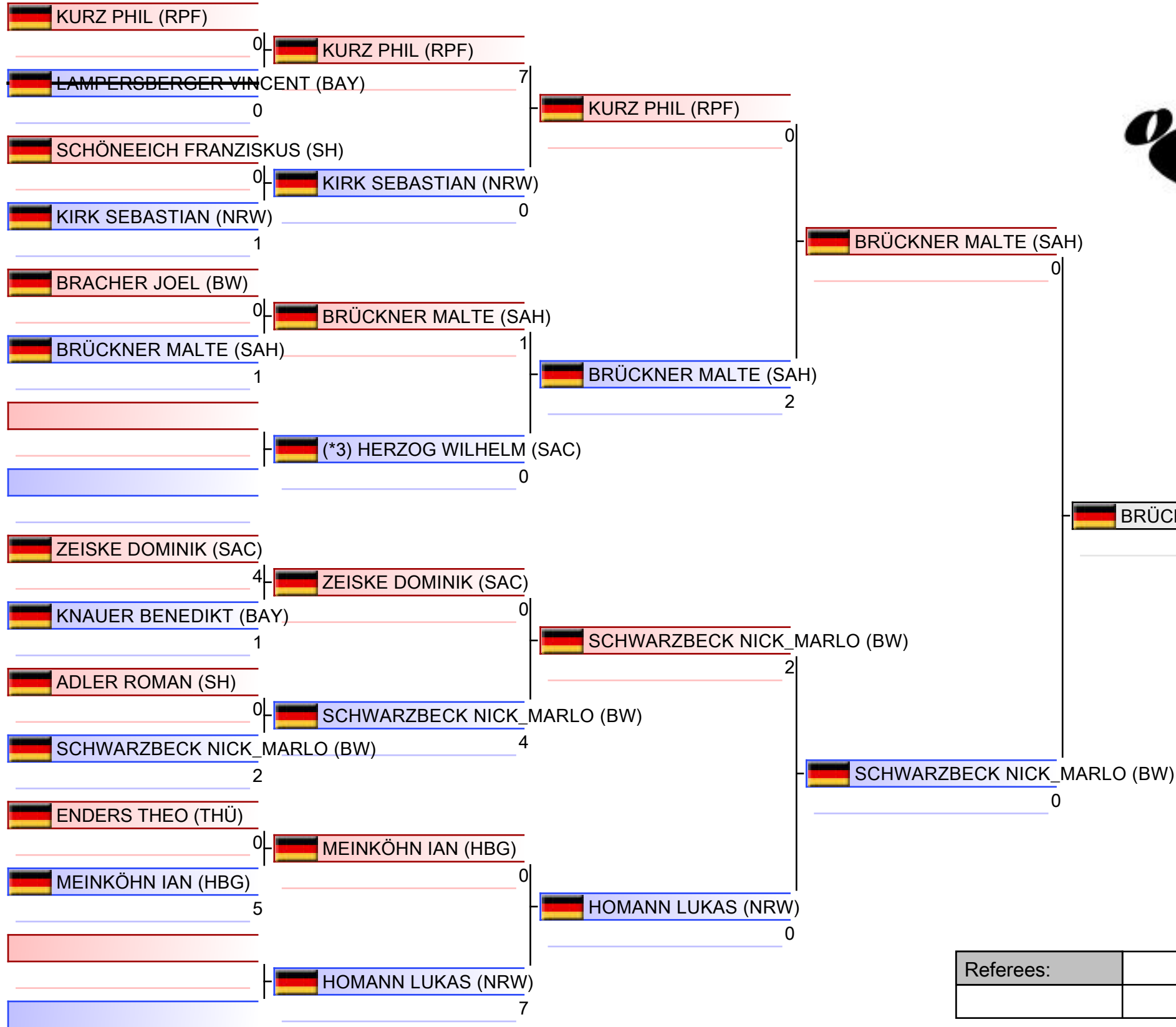

1. BRÜCKNER MALTE (SAH)
2. JÜNEMANN LINUS (THÜ)
3. AZADI JAHAN (HBG)
3. HERZOG WILHELM (SAC)
5. SCHMELING NILS (NS)
5. SCHWARZBECK NICK_MARLO (BW)
7. MEIER MIGUEL (NRW)
7. KURZ PHIL (RPF)

\*Gesetzt

Referees:			

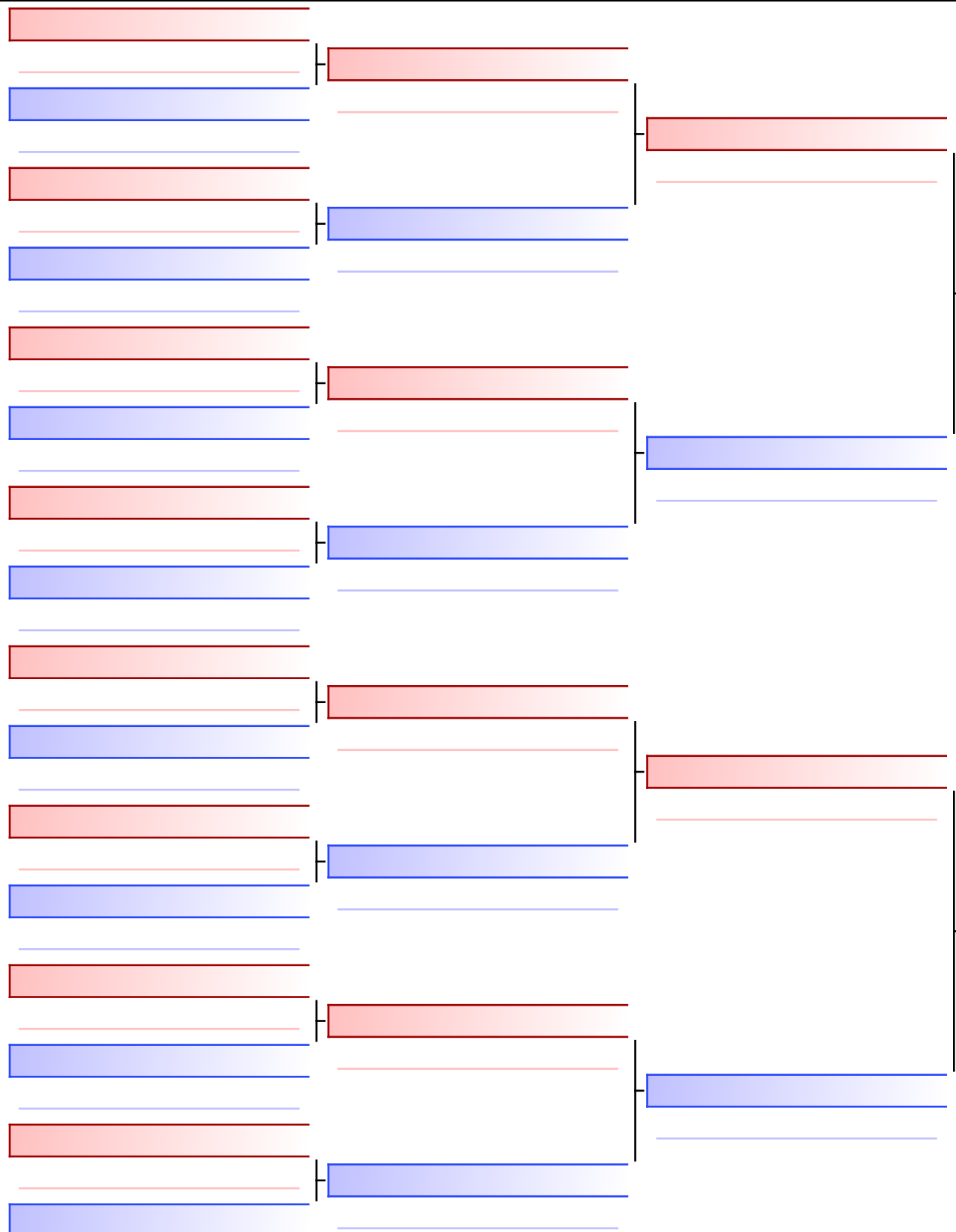

**Finale**

**JÜNEMANN LINUS (THÜ)**

1

**BRÜCKNER MALTE (SAH)**

**BRÜCKNER MALTE (SAH)**

2

1. BRÜCKNER MALTE (SAH)
2. JÜNEMANN LINUS (THÜ)
3. AZADI JAHAN (HBG)
3. HERZOG WILHELM (SAC)
5. SCHMELING NILS (NS)
5. SCHWARZBECK NICK_MARLO (BW)
7. MEIER MIGUEL (NRW)
7. KURZ PHIL (RPF)

\*Gesetzt

Referees:			

# Schüler A Kumite Einzel Jungen +49 kg

Deutsche Meisterschaft der Schüler 2021

Tatami  
4 15:35

Pool  
1,2

(c)sportdata GmbH & Co KG 2000-2021(2021-09-19 22:28) -WKF Approved- v 9.8.8 build 1 (2021-07-19) Lizenz: SDIL Sportdata Internal License 2021 (expire 2021-12-31)

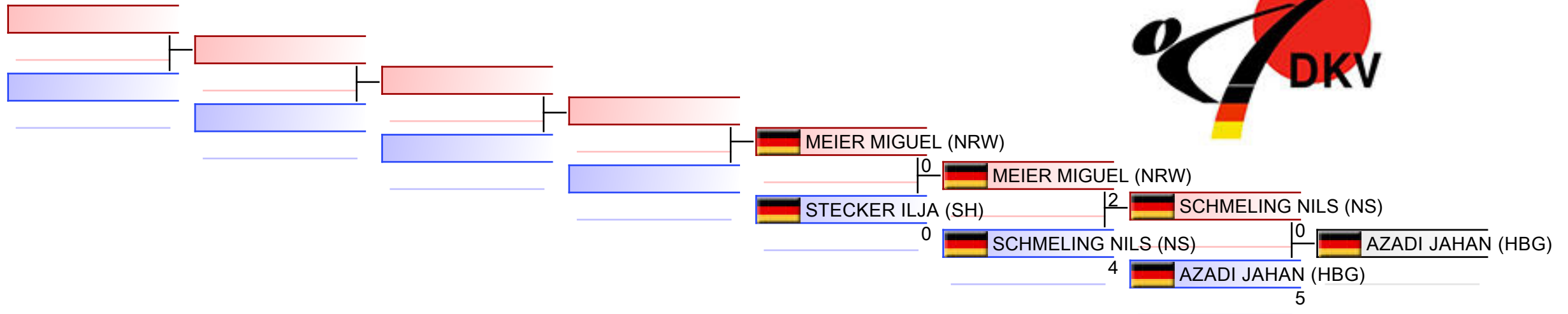

## TROSTRUNDE: (1,2)

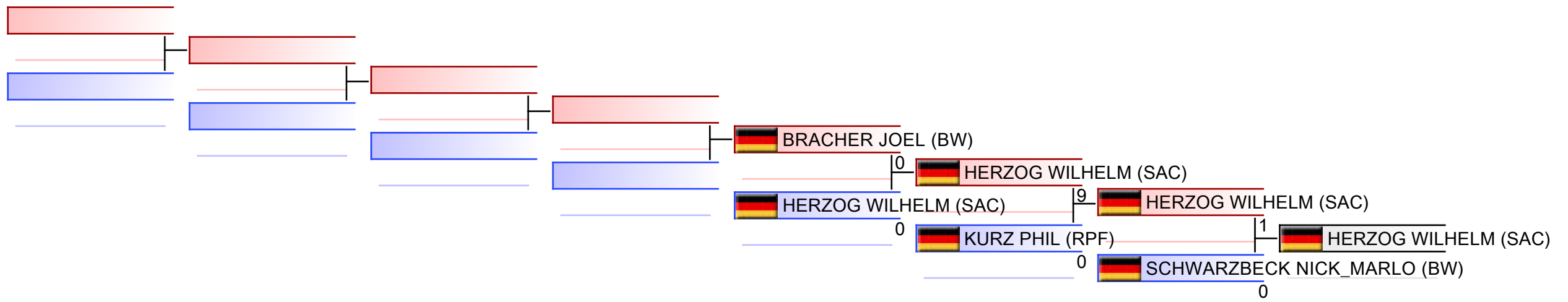

Referees:							
-----------	--	--	--	--	--	--	--

# Schüler A Kumite Einzel Mädchen -44 kg

Deutsche Meisterschaft der Schüler 2021, Horst-Korber-Sportzentrum, Am Glockenturm 3-5, 14053 Berlin, GER

Tatami  
3 13:20

Pool  
1/1

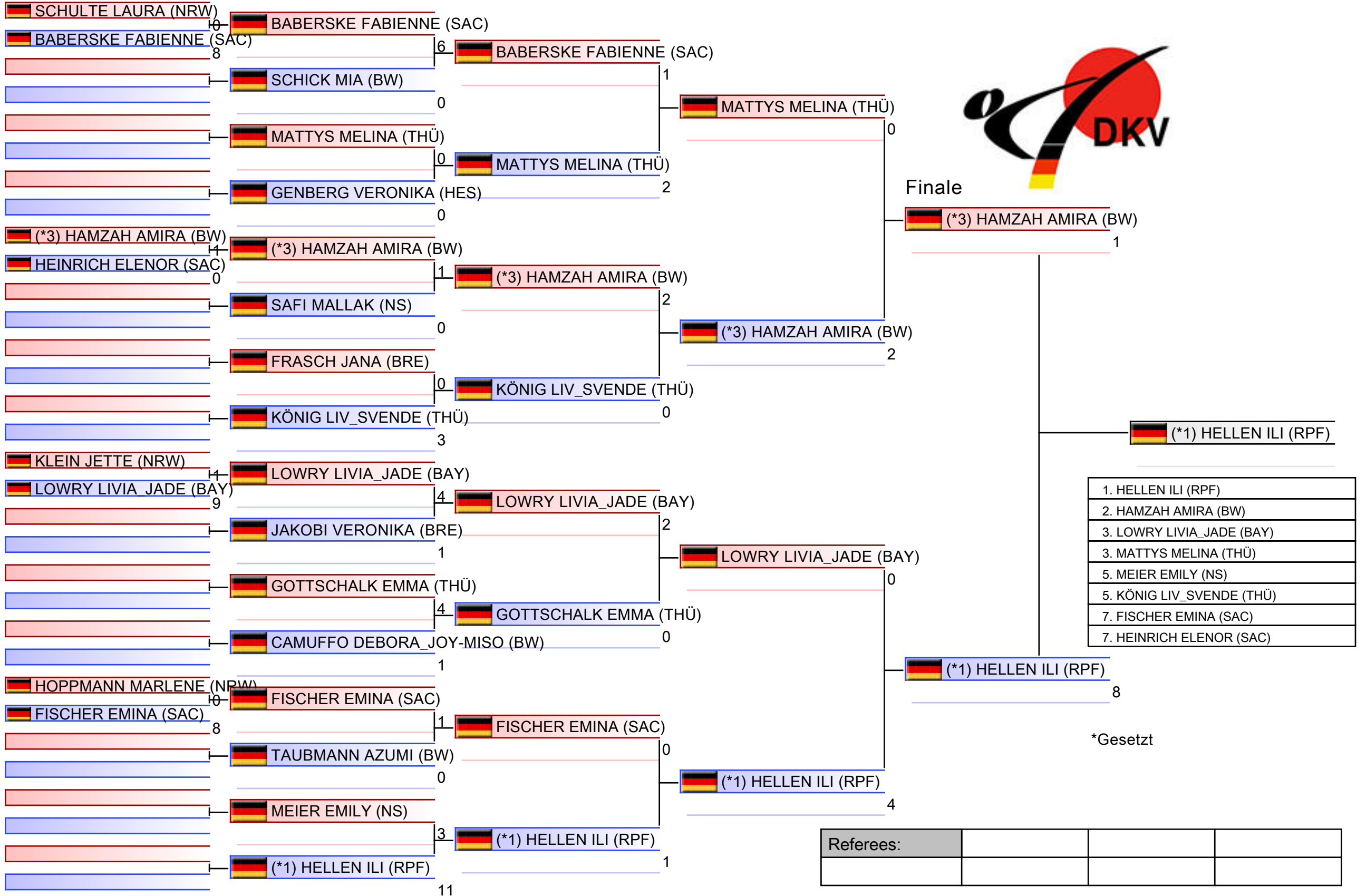

# Schüler A Kumite Einzel Mädchen -44 kg

Deutsche Meisterschaft der Schüler 2021

Tatami  
3 14:30

Pool  
1

(c)sportdata GmbH & Co KG 2000-2021(2021-09-19 22:28) -WKF Approved- v 9.8.8 build 1 (2021-07-19) Lizenz: SDIL Sportdata Internal License 2021 (expire 2021-12-31)

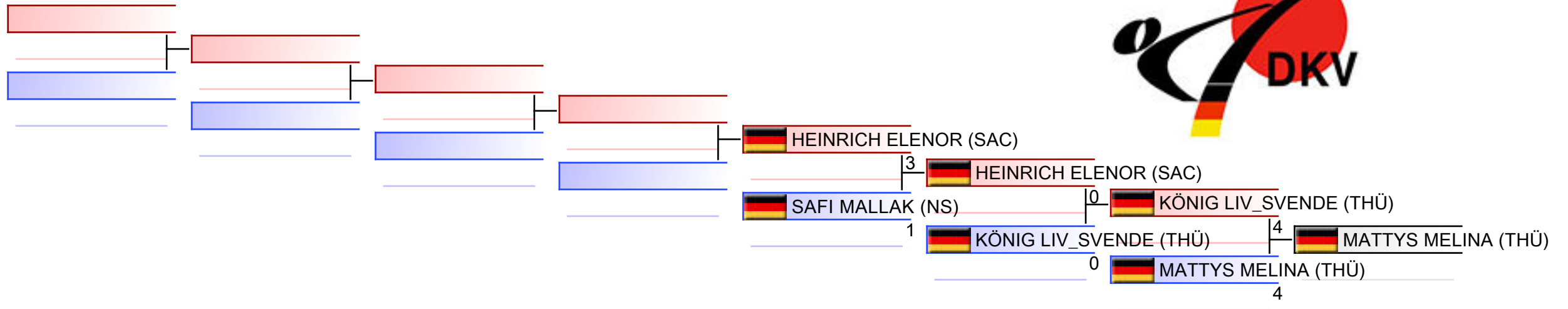

## TROSTRUNDE: (1)

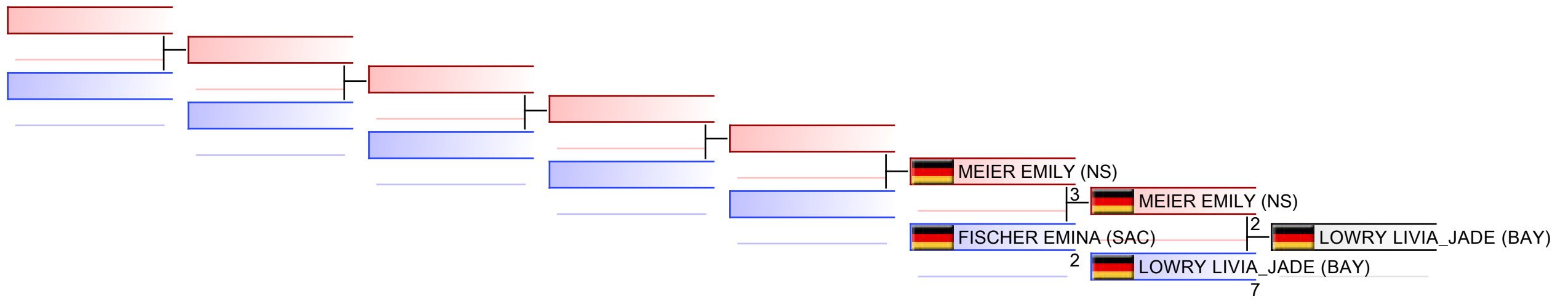

Referees:							
-----------	--	--	--	--	--	--	--

# Schüler A Kumite Einzel Mädchen -49 kg

Deutsche Meisterschaft der Schüler 2021, Horst-Korber-Sportzentrum, Am Glockenturm 3-5, 14053 Berlin, GER

Tatami  
4 11:45

Pool  
1/1

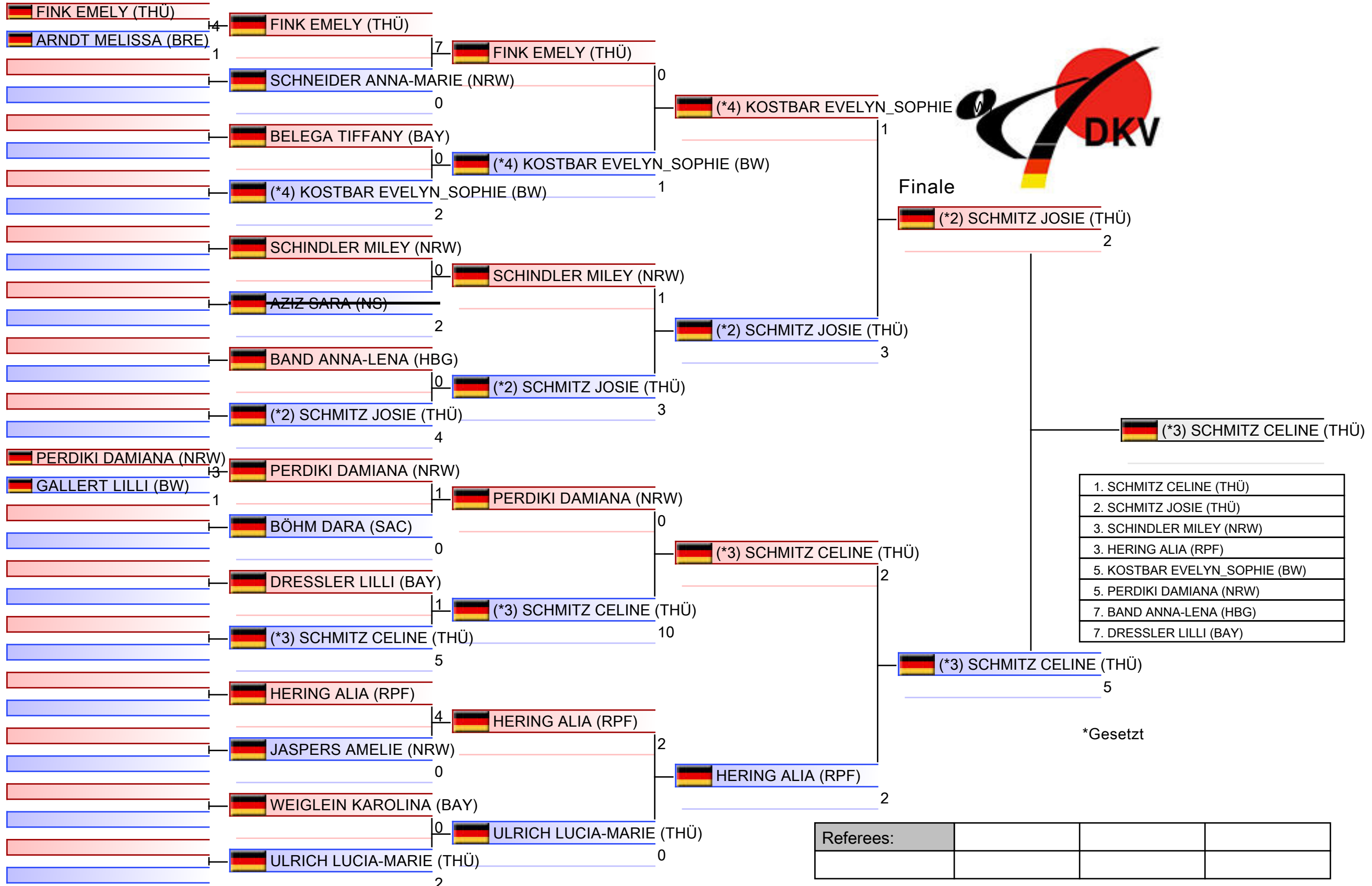

# Schüler A Kumite Einzel Mädchen -49 kg

Deutsche Meisterschaft der Schüler 2021

Tatami  
4 12:45

Pool  
1

(c)sportdata GmbH & Co KG 2000-2021(2021-09-19 22:28) -WKF Approved- v 9.8.8 build 1 (2021-07-19) Lizenz: SDIL Sportdata Internal License 2021 (expire 2021-12-31)

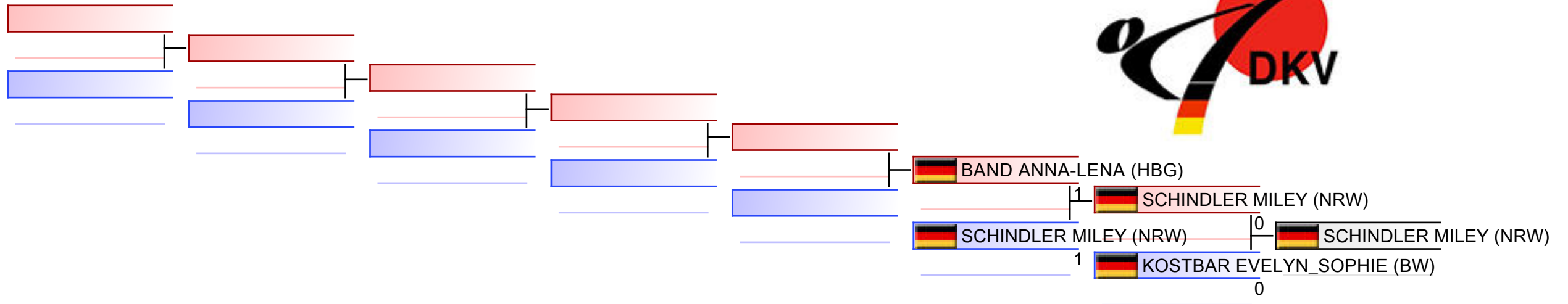

## TROSTRUNDE: (1)

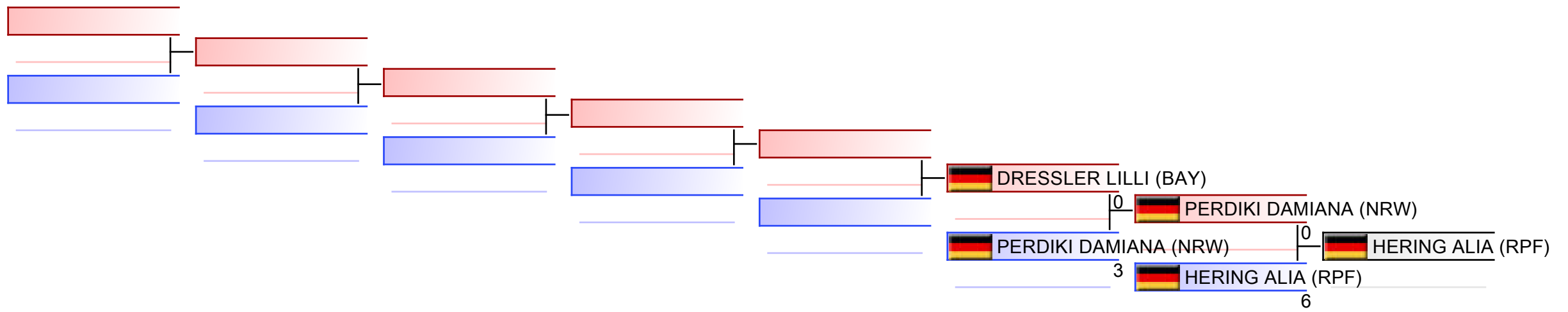

Referees:							
-----------	--	--	--	--	--	--	--



# Schüler A Kumite Einzel Mädchen +49 kg

Deutsche Meisterschaft der Schüler 2021, Horst-Korber-Sportzentrum, Am Glockenturm 3-5, 14053 Berlin, GER

Tatami  
1 14:00

Pool  
1/1

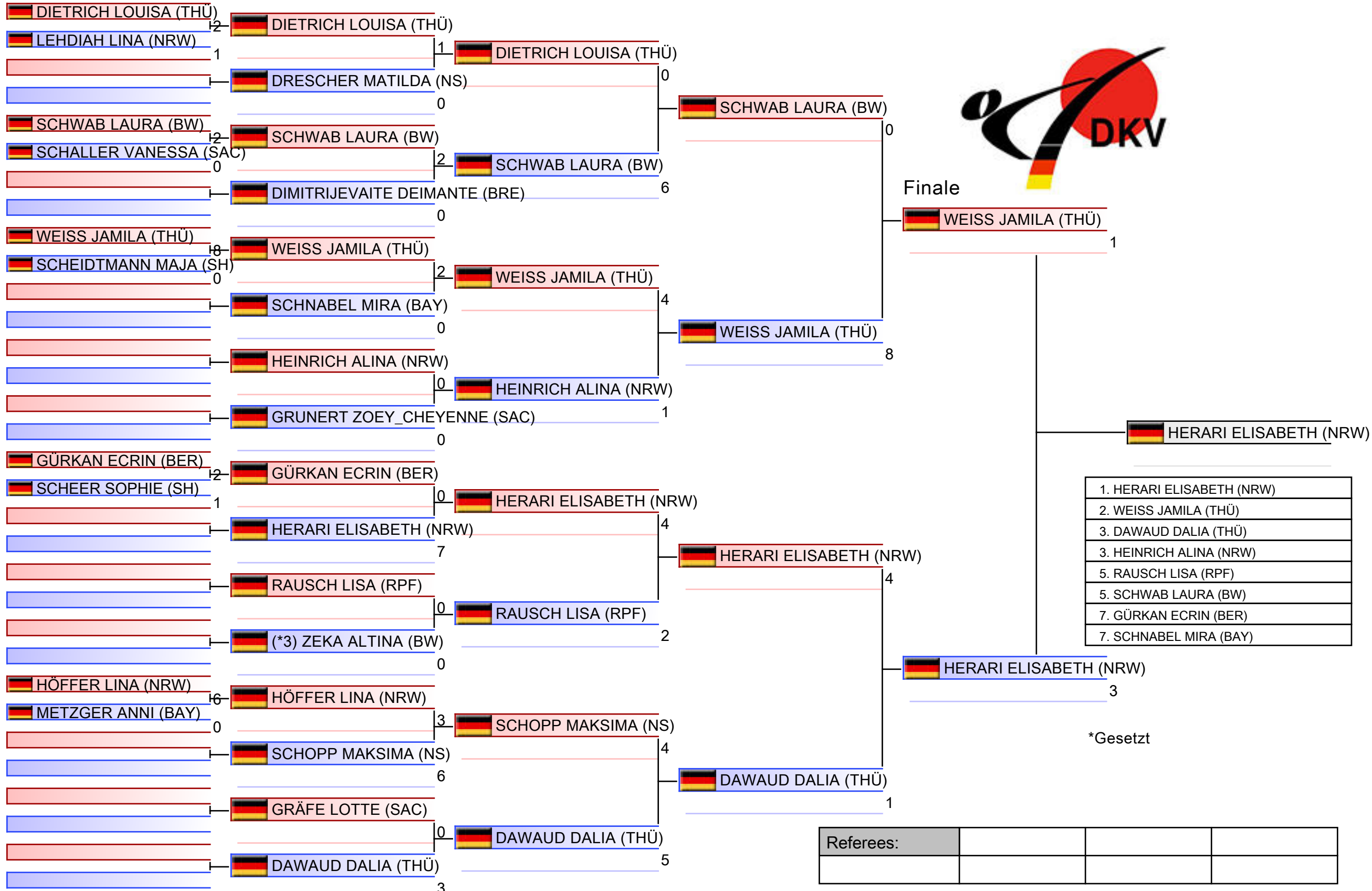

# Schüler A Kumite Einzel Mädchen +49 kg

Deutsche Meisterschaft der Schüler 2021

Tatami  
1 15:10

Pool  
1

(c)sportdata GmbH & Co KG 2000-2021(2021-09-19 22:28) -WKF Approved- v 9.8.8 build 1 (2021-07-19) Lizenz: SDIL Sportdata Internal License 2021 (expire 2021-12-31)

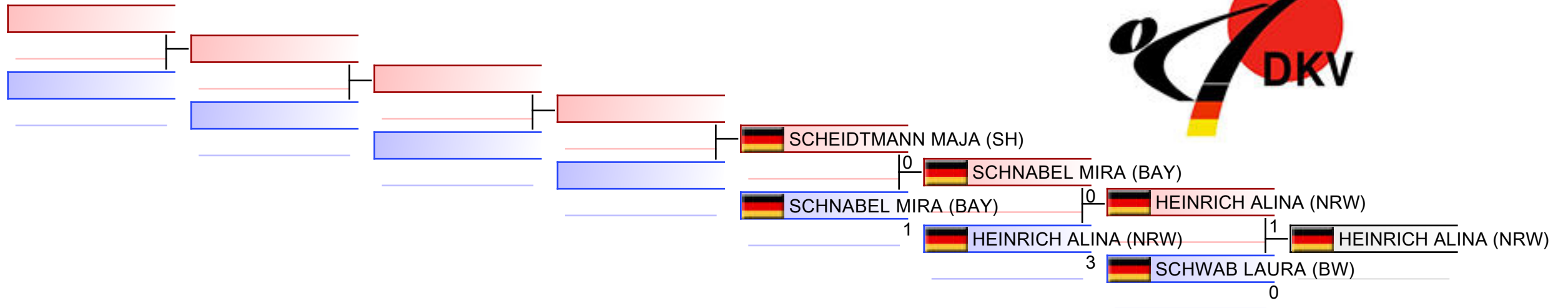

## TROSTRUNDE: (1)

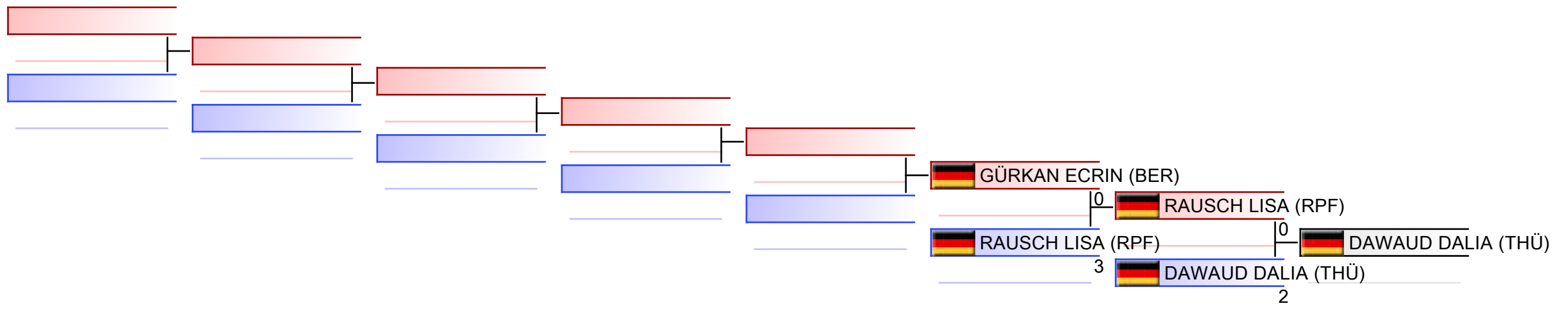

Referees:							
-----------	--	--	--	--	--	--	--

# Schüler A Kumite Einzel Mädchen -38 kg

Deutsche Meisterschaft der Schüler 2021, Horst-Korber-Sportzentrum, Am Glockenturm 3-5, 14053 Berlin, GER

Tatami  
2 13:35

Pool  
1/1

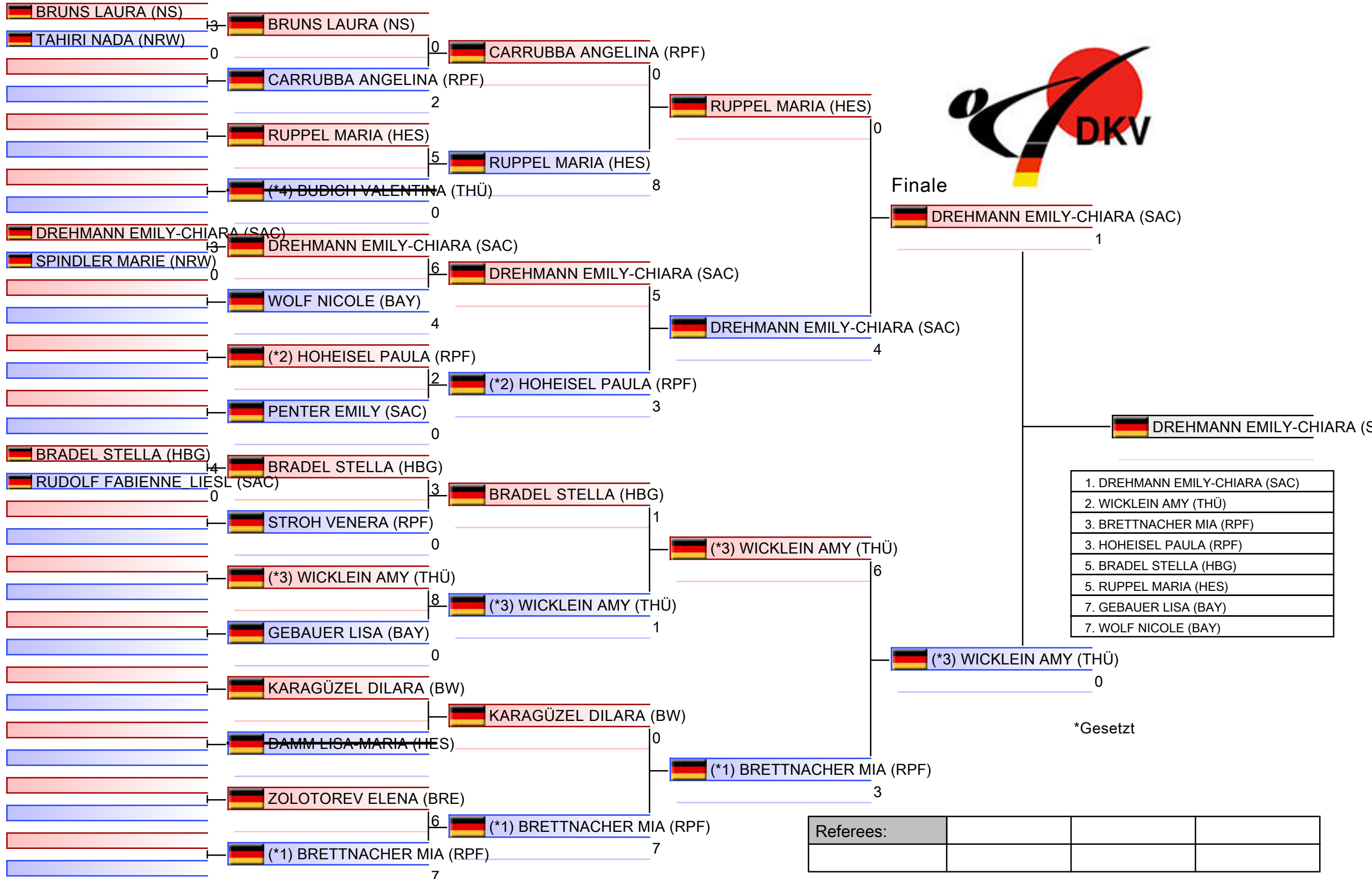

# Schüler A Kumite Einzel Mädchen -38 kg

Deutsche Meisterschaft der Schüler 2021

Tatami  
2 14:45

Pool  
1

(c)sportdata GmbH & Co KG 2000-2021(2021-09-19 22:28) -WKF Approved- v 9.8.8 build 1 (2021-07-19) Lizenz: SDIL Sportdata Internal License 2021 (expire 2021-12-31)

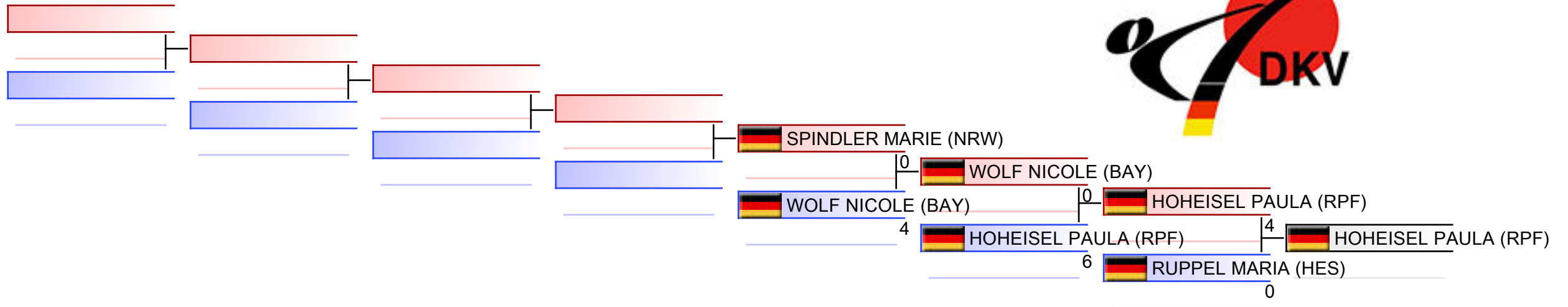

## TROSTRUNDE: (1)

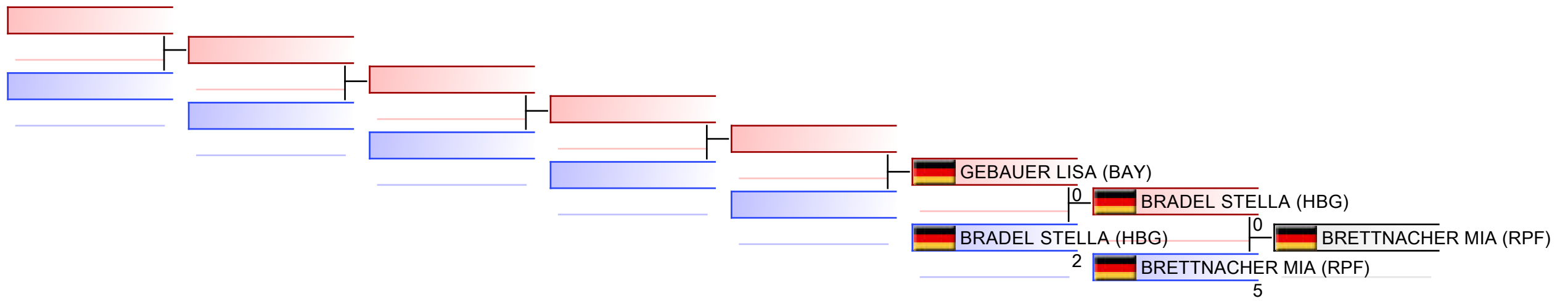

Referees:							
-----------	--	--	--	--	--	--	--

R1 G1/2 (10) Tatami 5 09:00

Teilnehmer	Kata	1T	1A	2T	2A	3T	3A	4T	4A	5T	5A	6T	6A	7T	7A	TEC	ATH	Extr	Gesam	Rang
1 KISTNER ANDREJ (BW)	SEISAN	7.2	(6.6)			6.8		7.2		(7.4)						21.2			21.2	6
2 PIRES VICTOR_TSOY_SIMOES (BER)	036 JION	(6.8)		7.2		(8.2)		6.8		7.0						21.0			21.0	7
3 SABANOVIC SAID (BAY)	029 HEIAN GODAN	6.6	(6.4)			(7.0)		6.4		6.4						19.4			19.4	10
4 BALLEWSKI MORITZ (THÜ)	006 BASSAI DAI	7.0	(7.8)			7.4		7.4		(6.8)						21.8			21.8	3
5 POISEL LUDWIG (BAY)	036 JION	6.6	6.8	(7.2)		6.6		(6.2)								20.0			20.0	9
6 KUNIYASU SHOUTA (BER)	040 KANKU DAI	7.8	(7.6)			(8.4)		7.6		8.0						23.4			23.4	2
7 JASON RICHTER (NRW)	012 ENPI	(7.6)		8.0		(8.6)		8.0		8.2						24.2			24.2	1
8 ANNAFIA MOHAMED_NOUR (NRW)	025 HEIAN SHODAN	7.4	(7.0)			7.0		(7.8)		7.0						21.4			21.4	5
9 FRASCH VIKTOR (BRE)	036 JION	(6.4)		7.2		(7.4)		7.0		6.4						20.6			20.6	8
10 BOLAND_BAKHSH ARIAN (RPF)	006 BASSAI DAI	7.2	6.8	7.6		(6.6)		(7.8)								21.6			21.6	4

R1 G2/2 (8) Tatami 6 09:00

Teilnehmer	Kata	1T	1A	2T	2A	3T	3A	4T	4A	5T	5A	6T	6A	7T	7A	TEC	ATH	Extr	Gesam	Rang
1 BUCKERT JONAS (THÜ)	012 ENPI	(6.8)		(7.2)		6.8		6.8		7.2						20.8			20.8	6
2 VÖLKER JOHN (RPF)	026 HEIAN NIDAN	6.4	(7.4)			6.6		(6.0)		6.6						19.6			19.6	7
3 SABANOVIC OMER (BAY)	026 HEIAN NIDAN	6.2	(6.4)			6.2		(5.8)		6.4						18.8			18.8	8
4 AETHNER RUBEN (BRE)	006 BASSAI DAI	7.4	(8.6)			7.2		6.6		(6.2)						21.2			21.2	5
5 IOANNIS NIKOLAIDIS (NRW)	021 GOJUSHIHO SHO	(6.8)		(8.0)		7.4		7.4		7.8						22.6			22.6	3
6 PFEIL MARLO (THÜ)	006 BASSAI DAI	7.4	(8.2)			(7.0)		7.0		7.0						21.4			21.4	4
7 ILLI DANIIL (BER)	036 JION	7.8	(8.4)			(7.2)		7.8		8.0						23.6			23.6	2
8 ELKAIEM MOHAMED (NRW)	012 ENPI	(8.2)		(8.6)		8.2		8.4		8.4						25.0			25.0	1

R2-G1

Teilnehmer	Kata	1T	1A	2T	2A	3T	3A	4T	4A	5T	5A	6T	6A	7T	7A	TEC	ATH	Extr	Gesam	Rang
1 BOLAND_BAKHSH ARIAN (RPF)	012 ENPI	(6.8)		6.8		6.8		(6.6)		6.8						20.4			20.4	4
2 KUNIYASU SHOUTA (BER)	041 KANKU SHO	(7.8)		7.4		(7.2)		7.4		7.4						22.2			22.2	2
3 JASON RICHTER (NRW)	021 GOJUSHIHO SHO	(8.0)		7.8		7.8		(7.6)		7.8						23.4			23.4	1
4 BALLEWSKI MORITZ (THÜ)	036 JION	(7.2)		7.2		(7.0)		7.0		7.0						21.2			21.2	3

R2-G2

Teilnehmer	Kata	1T	1A	2T	2A	3T	3A	4T	4A	5T	5A	6T	6A	7T	7A	TEC	ATH	Extr	Gesam	Rang
1 IOANNIS NIKOLAIDIS (NRW)	012 ENPI	(7.8)		(7.4)		7.4		7.6		7.6						22.6			22.6	3
2 PFEIL MARLO (THÜ)	036 JION	7.2		7.0		(6.8)		(7.4)		7.0						21.2			21.2	4
3 ILLI DANIIL (BER)	021 GOJUSHIHO SHO	(8.2)		7.8		(7.2)		7.8		8.2						23.8			23.8	2
4 ELKAIEM MOHAMED (NRW)	041 KANKU SHO	(8.6)		8.2		8.4		8.6		(8.0)						25.2			25.2	1

R3 Bronze Medal Match 1

Teilnehmer	Kata	1T	1A	2T	2A	3T	3A	4T	4A	5T	5A	6T	6A	7T	7A	TEC	ATH	Extr	Gesam	Rang
1 KUNIYASU SHOUTA (BER)	021 GOJUSHIHO SHO	(6.8)		(7.6)		7.6		(7.8)		7.4		(6.8)		7.6		22.6			22.6	1
2 IOANNIS NIKOLAIDIS (NRW)	036 JION	(6.4)		(7.0)		(7.2)		7.2		(7.8)		7.2		7.0		21.4			21.4	2





R3 Bronze Medal Match 2

Teilnehmer	Kata	1T	1A	2T	2A	3T	3A	4T	4A	5T	5A	6T	6A	7T	7A	TEC	ATH	Extr	Gesam	Rang
1 BALLEWSKI MORITZ (THÜ)	012 ENPI	6.8		(7.4)		(7.4)		6.8		(6.6)		(6.6)		6.8		20.4			20.4	2
2 ILLI DANIIL (BER)	012 ENPI	7.6		(7.8)		(8.0)		7.4		(6.4)		(7.2)		7.2		22.2			22.2	1

R3 Gold Medal Match

Teilnehmer	Kata	1T	1A	2T	2A	3T	3A	4T	4A	5T	5A	6T	6A	7T	7A	TEC	ATH	Extr	Gesam	Rang
1 JASON RICHTER (NRW)	041 KANKU SHO	(8.2)		(7.4)		(7.6)		7.8		(8.0)		7.8		8.0		23.6			23.6	2
2 ELKAIEM MOHAMED (NRW)	021 GOJUSHIHO SHO	(8.6)		(7.0)		8.0		(7.4)		7.8		(8.2)		8.2		24.0			24.0	1

Results

1	ELKAIEM MOHAMED	BLACK LION SHOTOKAN KARATE KÖLN E.V.		GERMANY
2	JASON RICHTER	SHOTOKAN KARATE DOJO SATORI HILDEN E.V.		GERMANY
3	KUNIYASU SHOUTA	LV_BERLIN		GERMANY
3	ILLI DANIIL	LV_BERLIN		GERMANY

**Schüler B Kata Einzel Mädchen**
**R1 G1/4 (7) Tatami 5 09:30**

Teilnehmer	Kata	1T	1A	2T	2A	3T	3A	4T	4A	5T	5A	6T	6A	7T	7A	TEC	ATH	Extr	Gesam	Rang
1 LANGERER LAETIZIA (NS)	021 GOJUSHIHO SHO	7.4	(7.6)			7.4		7.6		(6.6)						22.4			22.4	3
2 BIEDEMANN HANNAH (BW)	012 ENPI	7.6	(7.2)	(7.8)				7.8		7.6						23.0			23.0	2
3 WALTHER MATHILDA (THÜ)	006 BASSAI DAI	6.8	(6.6)			6.8		(7.2)		7.0						20.6			20.6	6
4 SCHAUDIG LUISA (RPF)	020 GOJUSHIHO DAI	7.8	8.2	(7.6)				(8.4)		7.8						23.8			23.8	1
5 BESANCON JOEL JOSEPHINE (SAH)	041 KANKU SHO	(5.8)		6.6		6.6		(6.8)		6.8						20.0			20.0	7
6 WIENBECK RANI (BRE)	041 KANKU SHO	7.0		7.0		(7.2)		(6.2)		7.0						21.0			21.0	5
7 TANK VANESSA (NRW)	026 HEIAN NIDAN	(7.4)		7.2		7.4		(7.0)		7.2						21.8			21.8	4

**R1 G2/4 (6) Tatami 6 09:30**

Teilnehmer	Kata	1T	1A	2T	2A	3T	3A	4T	4A	5T	5A	6T	6A	7T	7A	TEC	ATH	Extr	Gesam	Rang
1 GRUBER DARIA (BRA)	012 ENPI	(7.2)		(8.2)		8.2		8.2		7.6						24.0			24.0	2
2 ASSMANN LINNEA (SAH)	001 ANAN	7.8		7.8		(7.0)		(8.0)		8.0						23.6			23.6	3
3 EHLING MAGDALENA (BAY)	041 KANKU SHO	(6.6)		6.8		6.8		(7.6)		6.8						20.4			20.4	6
4 UCAR BESIME_FIDANZIA (NRW)	029 HEIAN GODAN	(7.0)		7.4		7.8		(8.2)		7.4						22.6			22.6	4
5 HUBRICH TALIA (BER)	036 JION	(6.8)		7.0		7.4		(8.6)		7.0						21.4			21.4	5
6 BIEDEMANN GRETA (BW)	012 ENPI	(7.6)		8.0		8.6		(8.8)		8.6						25.2			25.2	1

**R1 G3/4 (6) Tatami 2 09:45**

Teilnehmer	Kata	1T	1A	2T	2A	3T	3A	4T	4A	5T	5A	6T	6A	7T	7A	TEC	ATH	Extr	Gesam	Rang
1 MÜLLER SARAH (BAY)	036 JION	(7.2)		6.2		(5.8)		5.8		5.8						17.8			17.8	5
2 FEYGIN EMILY (NRW)	021 GOJUSHIHO SHO	6.8		(7.4)		(5.4)		6.4		6.8						20.0			20.0	4
3 RÖDER LUISE (THÜ)	006 BASSAI DAI	7.8		(8.0)		7.8		(7.2)		7.8						23.4			23.4	1
4 BONITZ SOPHIA (SAC)	005 BASSAI	(7.0)		(7.2)		7.2		7.0		7.2						21.4			21.4	3
5 GOETHE MARIEL (BW)	040 KANKU DAI	(7.6)		(7.2)		7.6		7.6		7.6						22.8			22.8	2
6 TECKERT EMMA (NS)	012 ENPI																			

**R1 G4/4 (6) Tatami 3 09:45**

Teilnehmer	Kata	1T	1A	2T	2A	3T	3A	4T	4A	5T	5A	6T	6A	7T	7A	TEC	ATH	Extr	Gesam	Rang
1 LAMPERSBERGER EMILIA (BAY)	029 HEIAN GODAN	(6.4)		(7.0)		6.6		6.8		6.8						20.2			20.2	6
2 BELZ AILA (BW)	036 JION	(7.0)		(7.4)		7.2		7.2		7.2						21.6			21.6	5
3 BIYIK ECRIN (NRW)	090 SHISOCHIN	(7.4)		8.0		8.0		7.8		(8.2)						23.8			23.8	3
4 LANGERER STELLA (NS)	021 GOJUSHIHO SHO	8.4		(7.8)		8.4		8.2		(8.6)						25.0			25.0	2
5 ISKANDARYAN ANNE-MARIE (RPF)	012 ENPI	8.8		(8.4)		8.6		8.6		(9.0)						26.0			26.0	1
6 LIPPERT HELENA (THÜ)	006 BASSAI DAI	(8.6)		8.2		7.8		(7.4)		7.6						23.6			23.6	4

**R2-G1**

Teilnehmer	Kata	1T	1A	2T	2A	3T	3A	4T	4A	5T	5A	6T	6A	7T	7A	TEC	ATH	Extr	Gesam	Rang
1 BIEDEMANN HANNAH (BW)	021 GOJUSHIHO SHO	(7.4)		(8.4)		7.8		7.8		7.6						23.2			23.2	4
2 UCAR BESIME_FIDANZIA (NRW)	GOJUSHIHO SHO	7.0		(7.2)		7.2		6.8		(6.6)						21.0			21.0	7
3 LANGERER LAETIZIA (NS)	041 KANKU SHO	(8.2)		7.6		7.4		7.4		(7.2)						22.4			22.4	5
4 SCHAUDIG LUISA (RPF)	041 KANKU SHO	(8.6)		8.0		(7.6)		8.4		8.0						24.4			24.4	2
5 GRUBER DARIA (BRA)	021 GOJUSHIHO SHO	8.4		(8.6)		8.2		(7.6)		7.8						24.4			24.4	3
6 TANK VANESSA (NRW)	028 HEIAN YONDAN	(6.6)		(6.8)		6.8		6.6		6.6						20.0			20.0	8
7 ASSMANN LINNEA (SAH)	008 CHATANYARA KUSHANKU	(7.8)		7.6		(7.0)		7.2		7.2						22.0			22.0	6
8 BIEDEMANN GRETA (BW)	040 KANKU DAI	(7.6)		8.2		(8.4)		8.2		8.4						24.8			24.8	1

**R2-G2**

Teilnehmer	Kata	1T	1A	2T	2A	3T	3A	4T	4A	5T	5A	6T	6A	7T	7A	TEC	ATH	Extr	Gesam	Rang
1 LIPPERT HELENA (THÜ)	036 JION	(7.0)		7.4		7.2		7.0		(7.6)						21.6			21.6	4
2 FEYGIN EMILY (NRW)	040 KANKU DAI	(5.8)		6.4		6.4		(6.8)		6.6						19.4			19.4	8
3 BONITZ SOPHIA (SAC)	074 PINAN GODAN	(6.4)		6.6		6.8		6.6		(7.0)						20.0			20.0	7
4 GOETHE MARIEL (BW)	012 ENPI	(6.8)		7.0		7.2		(7.4)		6.8						21.0			21.0	6
5 BIYIK ECRIN (NRW)	080 SANSEU	(6.4)		(7.2)		7.0		7.0		7.2						21.2			21.2	5
6 RÖDER LUISE (THÜ)	036 JION	(7.4)		7.4		7.4		(7.0)		7.4						22.2			22.2	3
7 ISKANDARYAN ANNE-MARIE (RPF)	021 GOJUSHIHO SHO	(7.0)		7.8		7.6		7.4		(8.0)						22.8			22.8	1
8 LANGERER STELLA (NS)	041 KANKU SHO	(6.8)		7.6		7.4		7.6		(7.8)						22.6			22.6	2

**R3-G1**

Teilnehmer	Kata	1T	1A	2T	2A	3T	3A	4T	4A	5T	5A	6T	6A	7T	7A	TEC	ATH	Extr	Gesam	Rang
1 BIEDEMANN GRETA (BW)	041 KANKU SHO	8.4		(7.8)		8.2		(8.6)		8.6						25.2			25.2	2
2 SCHAUDIG LUISA (RPF)	021 GOJUSHIHO SHO	(8.2)		8.4		(8.6)		8.2		8.4						25.0			25.0	3
3 GRUBER DARIA (BRA)	040 KANKU DAI	8.6		(8.0)		(8.8)		8.0		8.0						24.6			24.6	4
4 BIEDEMANN HANNAH (BW)	041 KANKU SHO	(9.0)		8.6		9.0		(8.2)		8.4						26.0			26.0	1

### R3-G2

Teilnehmer	Kata	1 T	1 A	2 T	2 A	3 T	3 A	4 T	4 A	5 T	5 A	6 T	6 A	7 T	7 A	TEC	ATH	Extr	Gesam	Rang
1 LANGERER STELLA (NS)	020 GOJUSHIHO DAI	7.2		(7.8)		7.6		(7.0)		7.4						22.2			22.2	4
2 ISKANDARYAN ANNE-MARIE (RPF)	041 KANKU SHO	(8.0)		8.0		7.8		(7.6)		7.6						23.4			23.4	1
3 LIPPERT HELENA (THÜ)	041 KANKU SHO	7.6		7.6		(7.2)		7.4		(7.8)						22.6			22.6	3
4 RÖDER LUISE (THÜ)	012 ENPI	7.8		(8.2)		7.4		(7.2)		7.4						22.6			22.6	2

### R4 Bronze Medal Match 1

Teilnehmer	Kata	1 T	1 A	2 T	2 A	3 T	3 A	4 T	4 A	5 T	5 A	6 T	6 A	7 T	7 A	TEC	ATH	Extr	Gesam	Rang
1 BIEDEMANN GRETA (BW)	040 KANKU DAI	(8.2)		(8.2)		8.2		(7.4)		8.0		(7.8)		8.2		24.4			24.4	1
2 LIPPERT HELENA (THÜ)	036 JION	7.6		7.8		(8.0)		(6.8)		7.6		(7.4)		(8.0)		23.0			23.0	2

### R4 Bronze Medal Match 2

Teilnehmer	Kata	1 T	1 A	2 T	2 A	3 T	3 A	4 T	4 A	5 T	5 A	6 T	6 A	7 T	7 A	TEC	ATH	Extr	Gesam	Rang
1 SCHAUDIG LUISA (RPF)	020 GOJUSHIHO DAI	(8.4)		(8.2)		8.4		8.2		8.2		(8.6)		(8.0)		24.8			24.8	1
2 RÖDER LUISE (THÜ)	006 BASSAI DAI	(8.0)		7.8		7.8		(2.0)		8.0		(8.4)		(7.6)		23.6			23.6	2

### R4 Gold Medal Match

Teilnehmer	Kata	1 T	1 A	2 T	2 A	3 T	3 A	4 T	4 A	5 T	5 A	6 T	6 A	7 T	7 A	TEC	ATH	Extr	Gesam	Rang
1 BIEDEMANN HANNAH (BW)	012 ENPI	(7.8)		8.0		8.0		8.0		(8.4)		(8.2)		(7.8)		24.0			24.0	1
2 ISKANDARYAN ANNE-MARIE (RPF)	020 GOJUSHIHO DAI	(7.4)		7.4		(7.6)		(7.2)		(8.0)		7.6		7.6		22.6			22.6	2

### Results

1	BIEDEMANN HANNAH	TSG ESSELINGEN		GERMANY
2	ISKANDARYAN ANNE-MARIE	1. SHOTOKAN KARATE CLUB FRANKENTHAL		GERMANY
3	BIEDEMANN GRETA	TSG ESSELINGEN		GERMANY
3	SCHAUDIG LUISA	1. SHOTOKAN KARATE CLUB FRANKENTHAL		GERMANY

# Schüler B Kumite Einzel Jungen -32 kg

Deutsche Meisterschaft der Schüler 2021, Horst-Korber-Sportzentrum, Am Glockenturm 3-5, 14053 Berlin, GER

Tatami  
1 12:25

Pool  
1/1

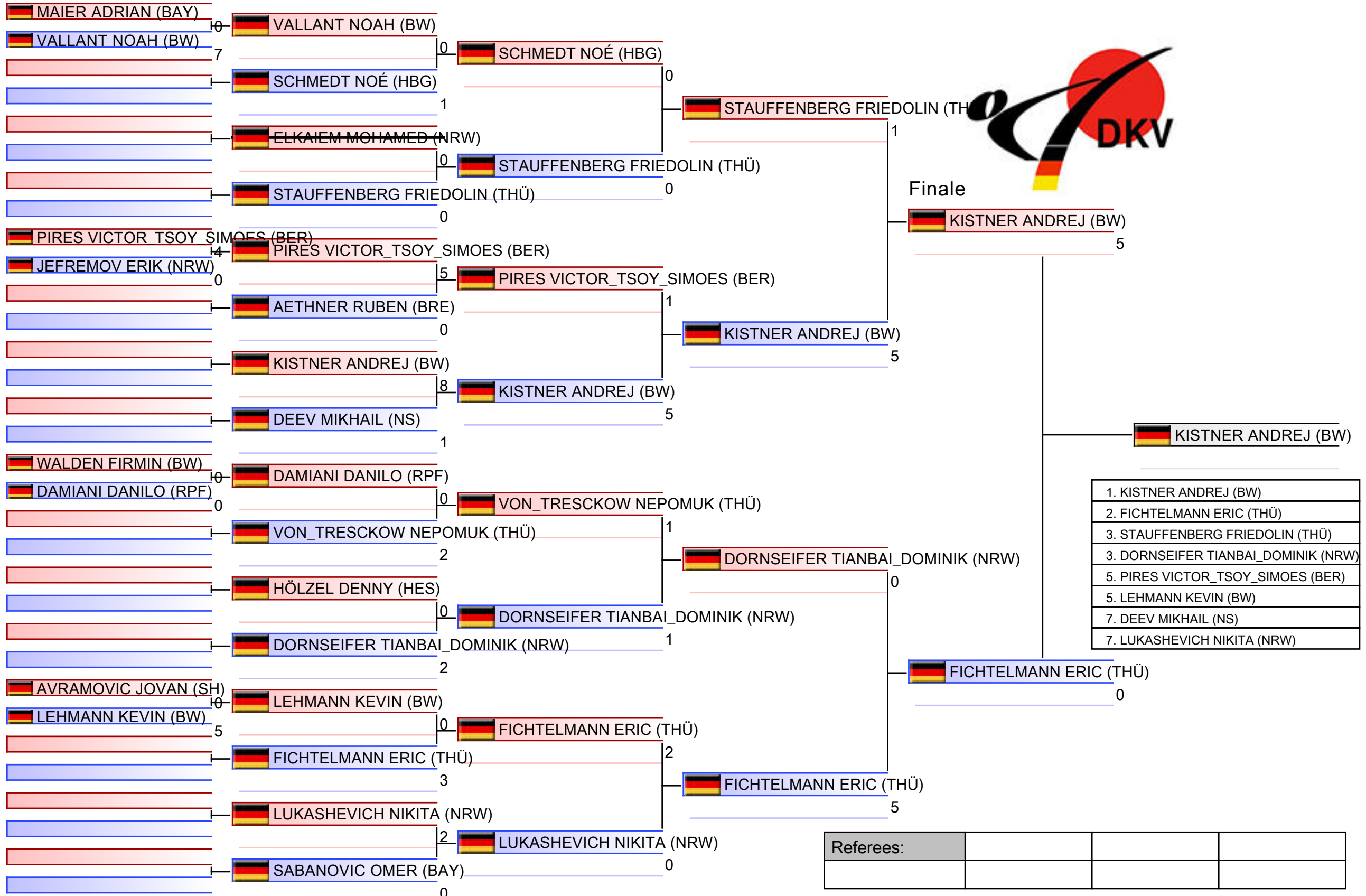



# Schüler B Kumite Einzel Jungen -32 kg

Deutsche Meisterschaft der Schüler 2021

Tatami  
1 13:35

Pool  
1

(c)sportdata GmbH & Co KG 2000-2021(2021-09-19 22:28) -WKF Approved- v 9.8.8 build 1 (2021-07-19) Lizenz: SDIL Sportdata Internal License 2021 (expire 2021-12-31)

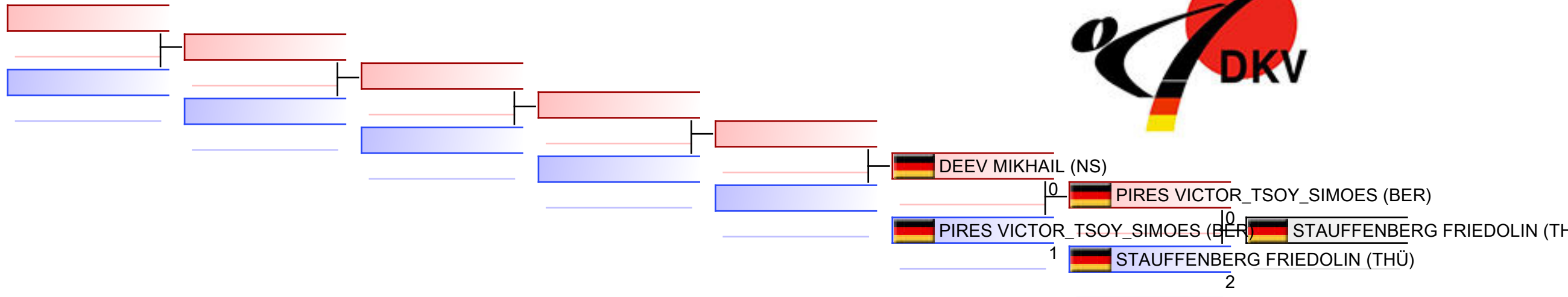

## TROSTRUNDE: (1)

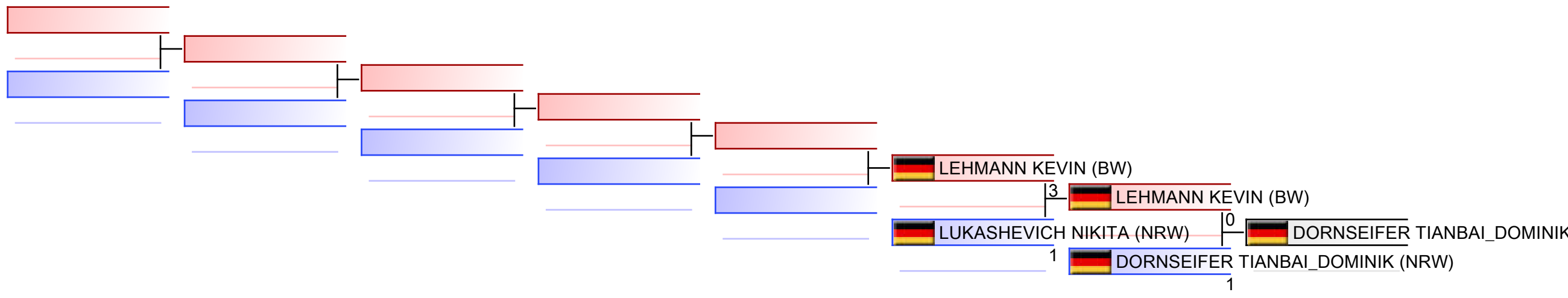

Referees:							
-----------	--	--	--	--	--	--	--

# Schüler B Kumite Einzel Jungen -38 kg

Deutsche Meisterschaft der Schüler 2021, Horst-Korber-Sportzentrum, Am Glockenturm 3-5, 14053 Berlin, GER

Tatami  
2 11:45

Pool  
1/1

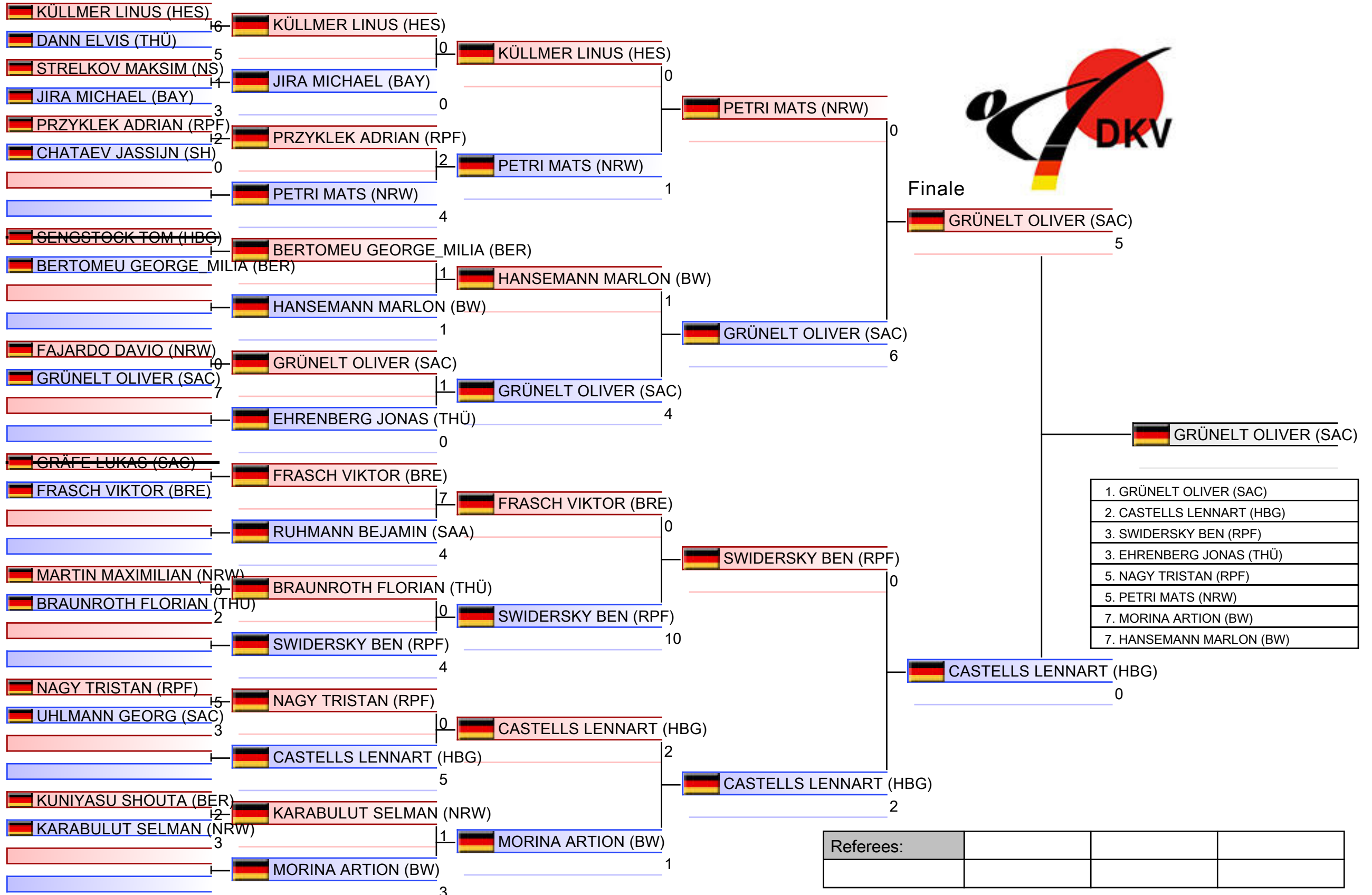

Referees:			

# Schüler B Kumite Einzel Jungen -38 kg

Deutsche Meisterschaft der Schüler 2021

Tatami  
2 13:10

Pool  
1

(c)sportdata GmbH & Co KG 2000-2021(2021-09-19 22:28) -WKF Approved- v 9.8.8 build 1 (2021-07-19) Lizenz: SDIL Sportdata Internal License 2021 (expire 2021-12-31)

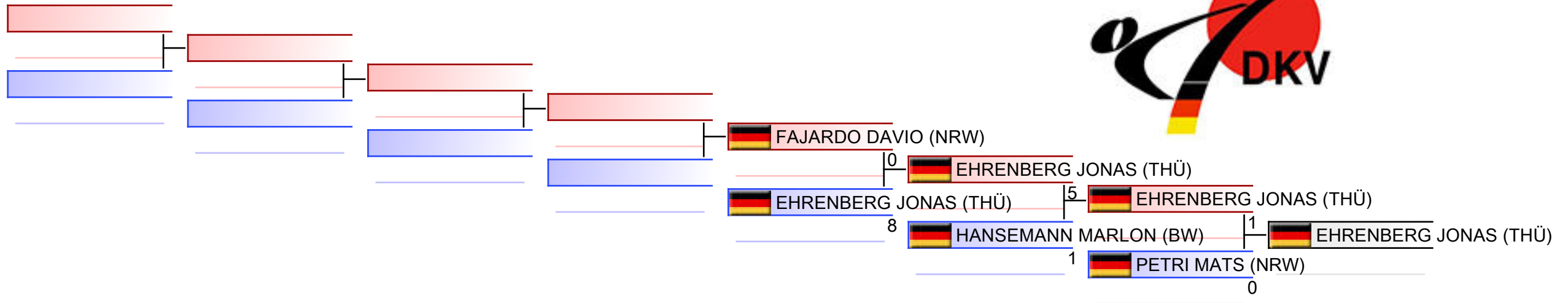

## TROSTRUNDE: (1)

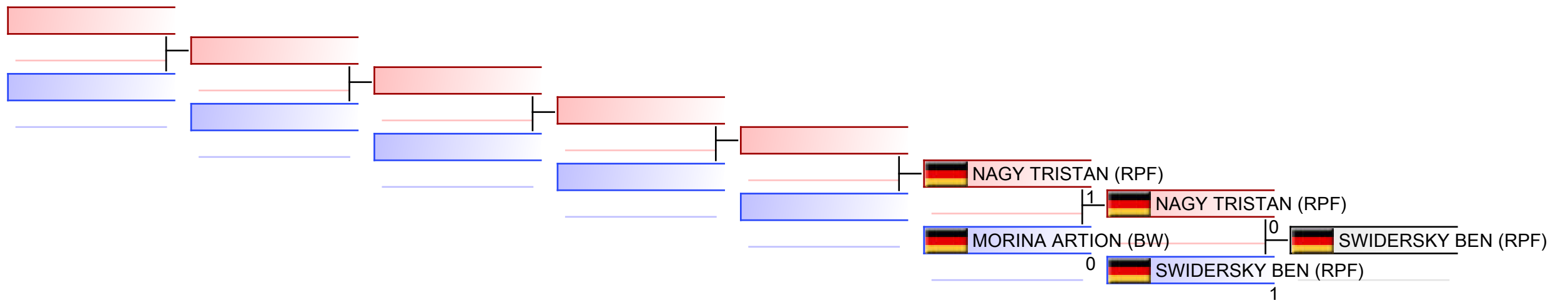

Referees:							
-----------	--	--	--	--	--	--	--

# Schüler B Kumite Einzel Jungen +38 kg

Deutsche Meisterschaft der Schüler 2021, Horst-Korber-Sportzentrum, Am Glockenturm 3-5, 14053 Berlin, GER

Tatami  
3 11:45

Pool  
1/1

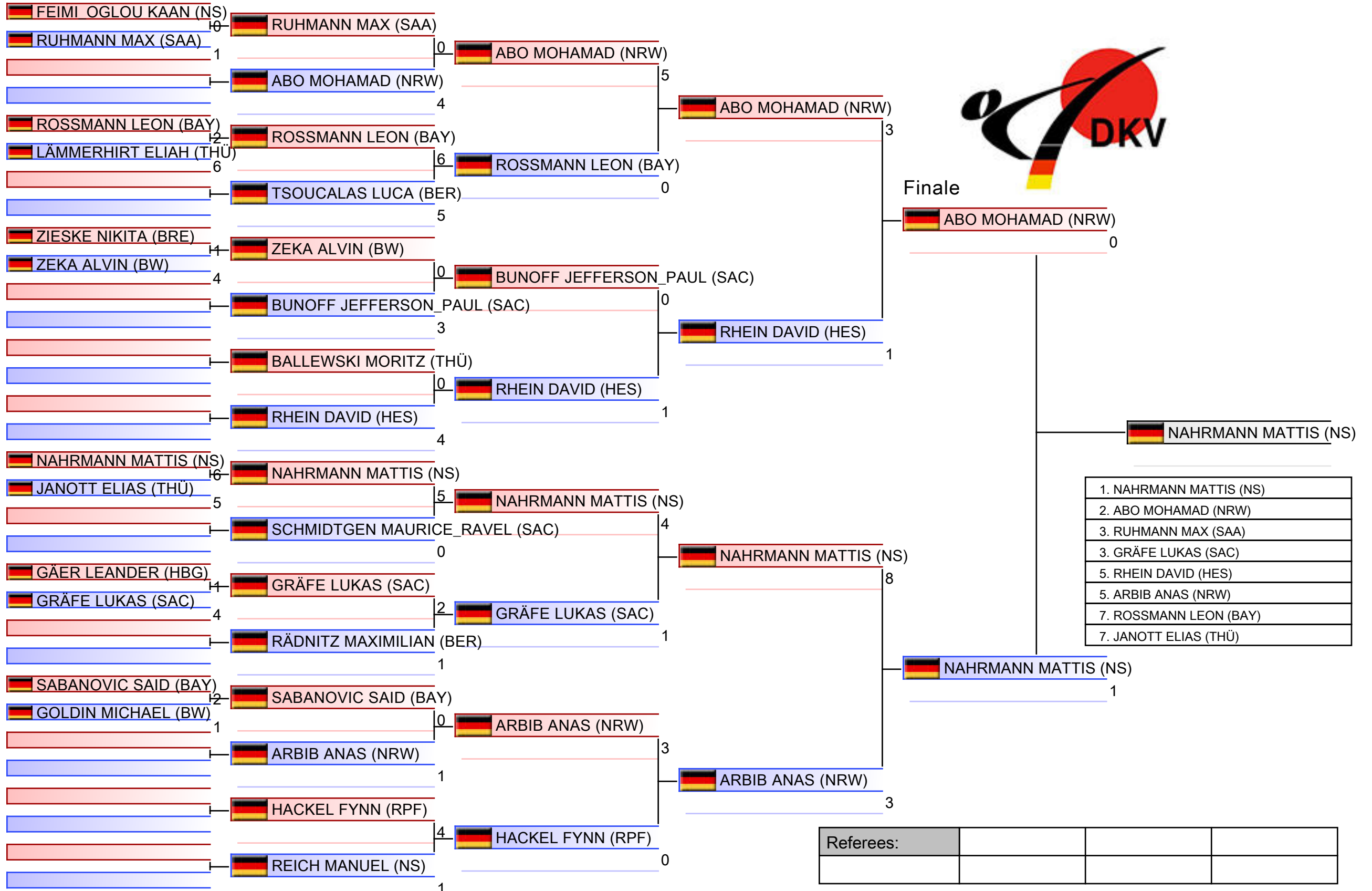

Referees:			

# Schüler B Kumite Einzel Jungen +38 kg

Deutsche Meisterschaft der Schüler 2021

Tatami  
3 12:55

Pool  
1

(c)sportdata GmbH & Co KG 2000-2021(2021-09-19 22:28) -WKF Approved- v 9.8.8 build 1 (2021-07-19) Lizenz: SDIL Sportdata Internal License 2021 (expire 2021-12-31)

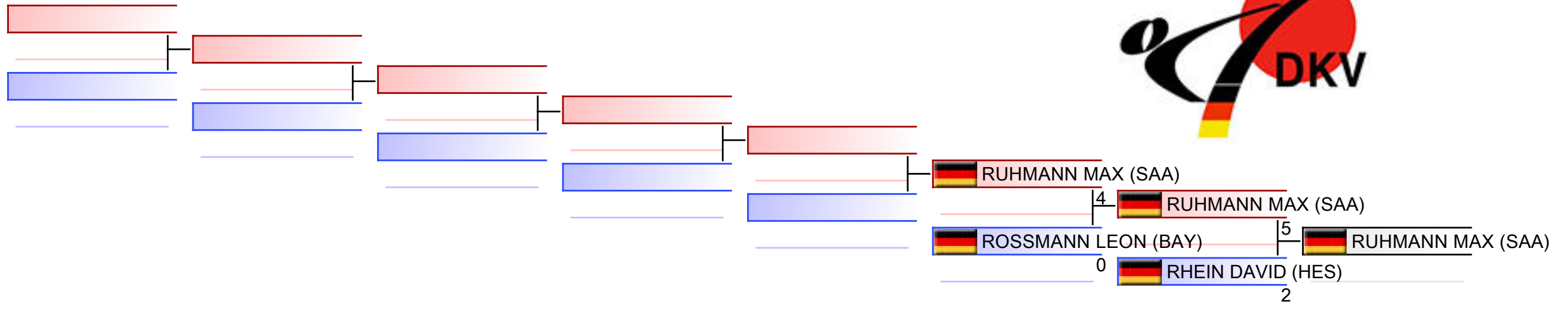

## TROSTRUNDE: (1)

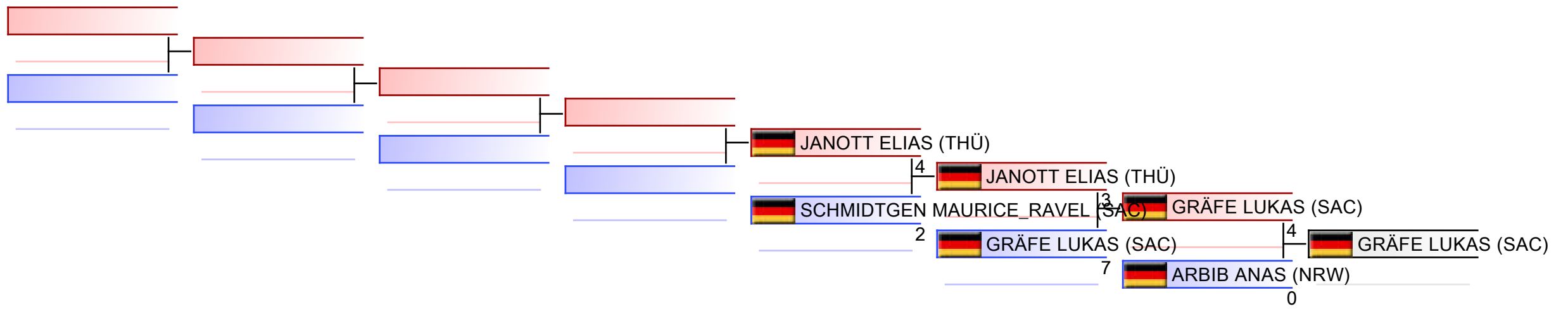

Referees:							
-----------	--	--	--	--	--	--	--

# Schüler B Kumite Einzel Mädchen -30 kg

Deutsche Meisterschaft der Schüler 2021, Horst-Korber-Sportzentrum, Am Glockenturm 3-5, 14053 Berlin, GER

Tatami  
1 11:45

Pool  
1/1

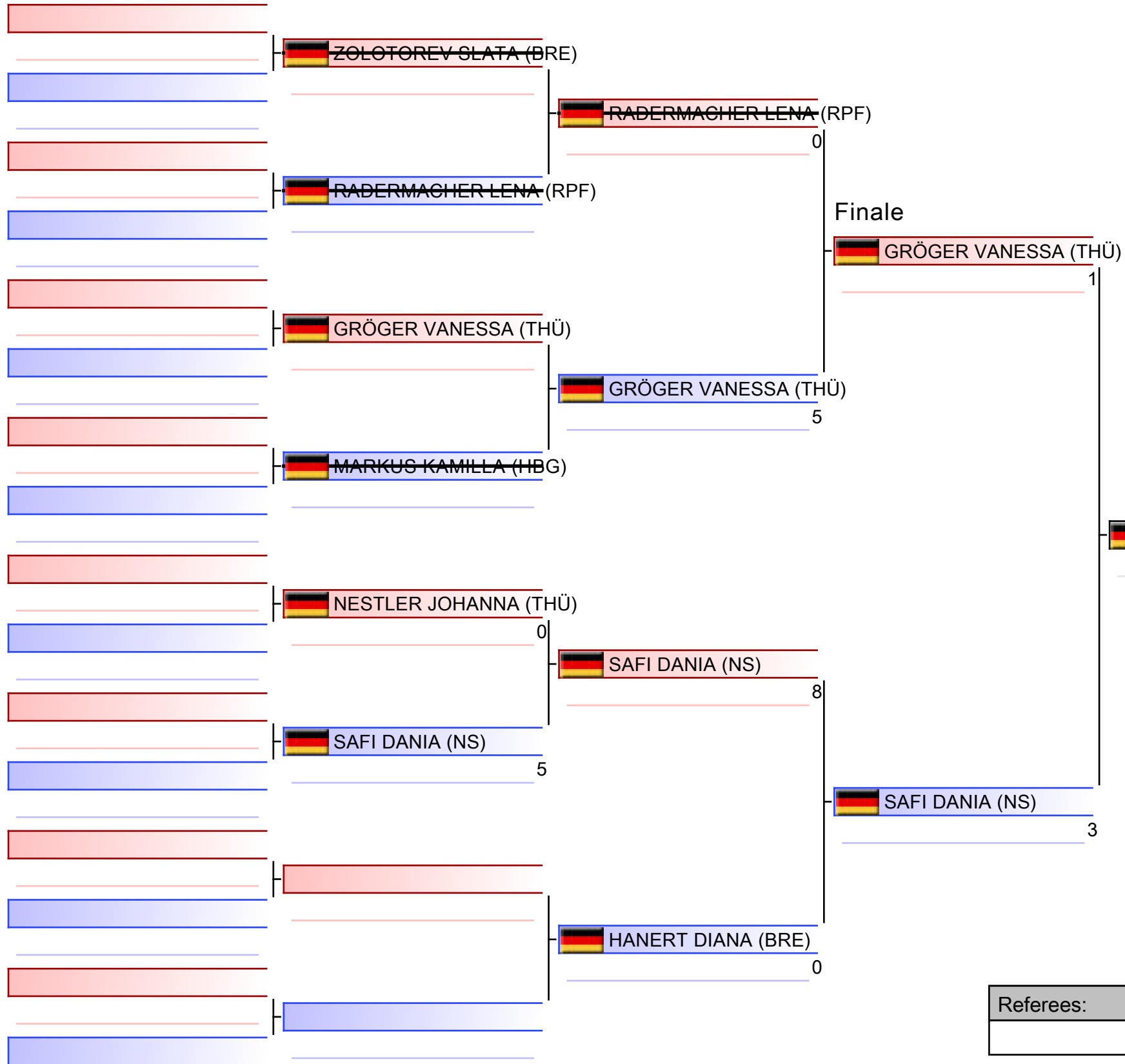

1. SAFI DANIA (NS)
2. GRÖGER VANESSA (THÜ)
3. HANERT DIANA (BRE)
5. NESTLER JOHANNA (THÜ)

Referees:			



# Schüler B Kumite Einzel Mädchen -36 kg

Deutsche Meisterschaft der Schüler 2021, Horst-Korber-Sportzentrum, Am Glockenturm 3-5, 14053 Berlin, GER

Tatami  
5 11:45

Pool  
1/1

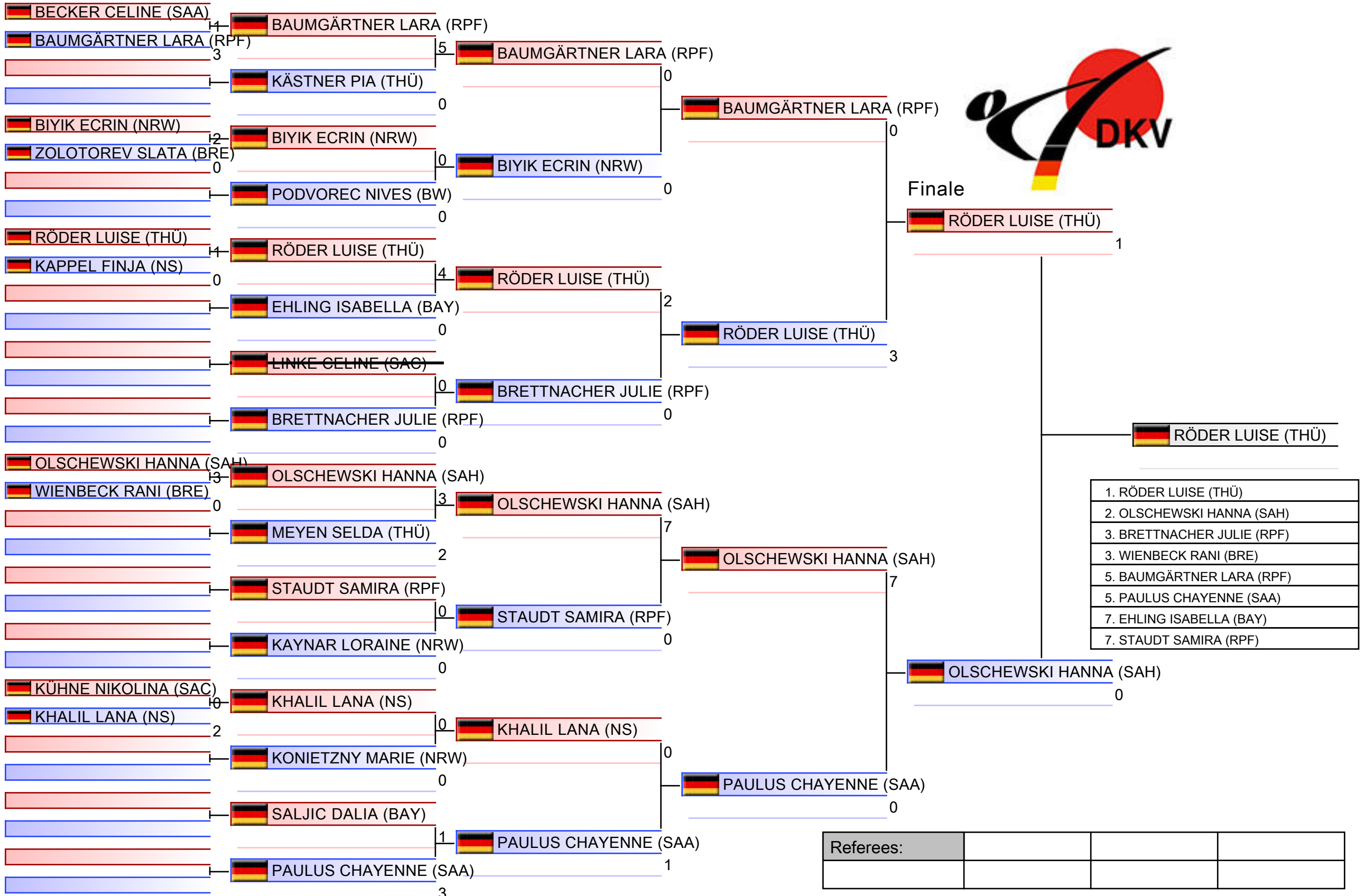

Referees:			



# Schüler B Kumite Einzel Mädchen -36 kg

Deutsche Meisterschaft der Schüler 2021

Tatami  
5 12:55

Pool  
1

(c)sportdata GmbH & Co KG 2000-2021(2021-09-19 22:28) -WKF Approved- v 9.8.8 build 1 (2021-07-19) Lizenz: SDIL Sportdata Internal License 2021 (expire 2021-12-31)

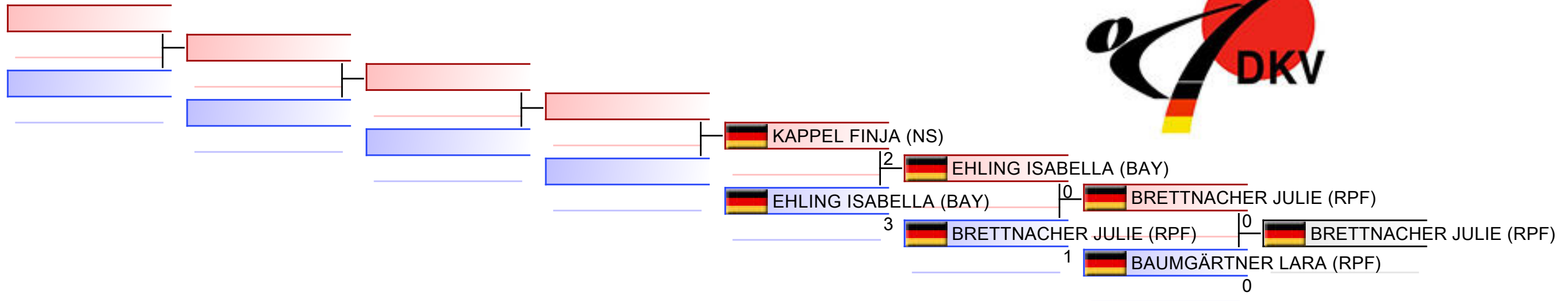

## TROSTRUNDE: (1)

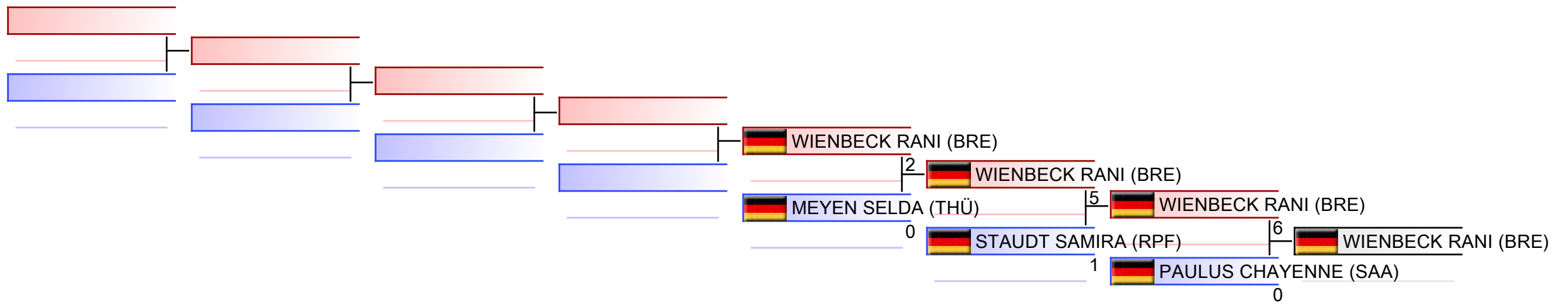

Referees:							
-----------	--	--	--	--	--	--	--

# Schüler B Kumite Einzel Mädchen +36 kg

Deutsche Meisterschaft der Schüler 2021, Horst-Korber-Sportzentrum, Am Glockenturm 3-5, 14053 Berlin, GER

Tatami  
6 11:45

Pool  
1/1

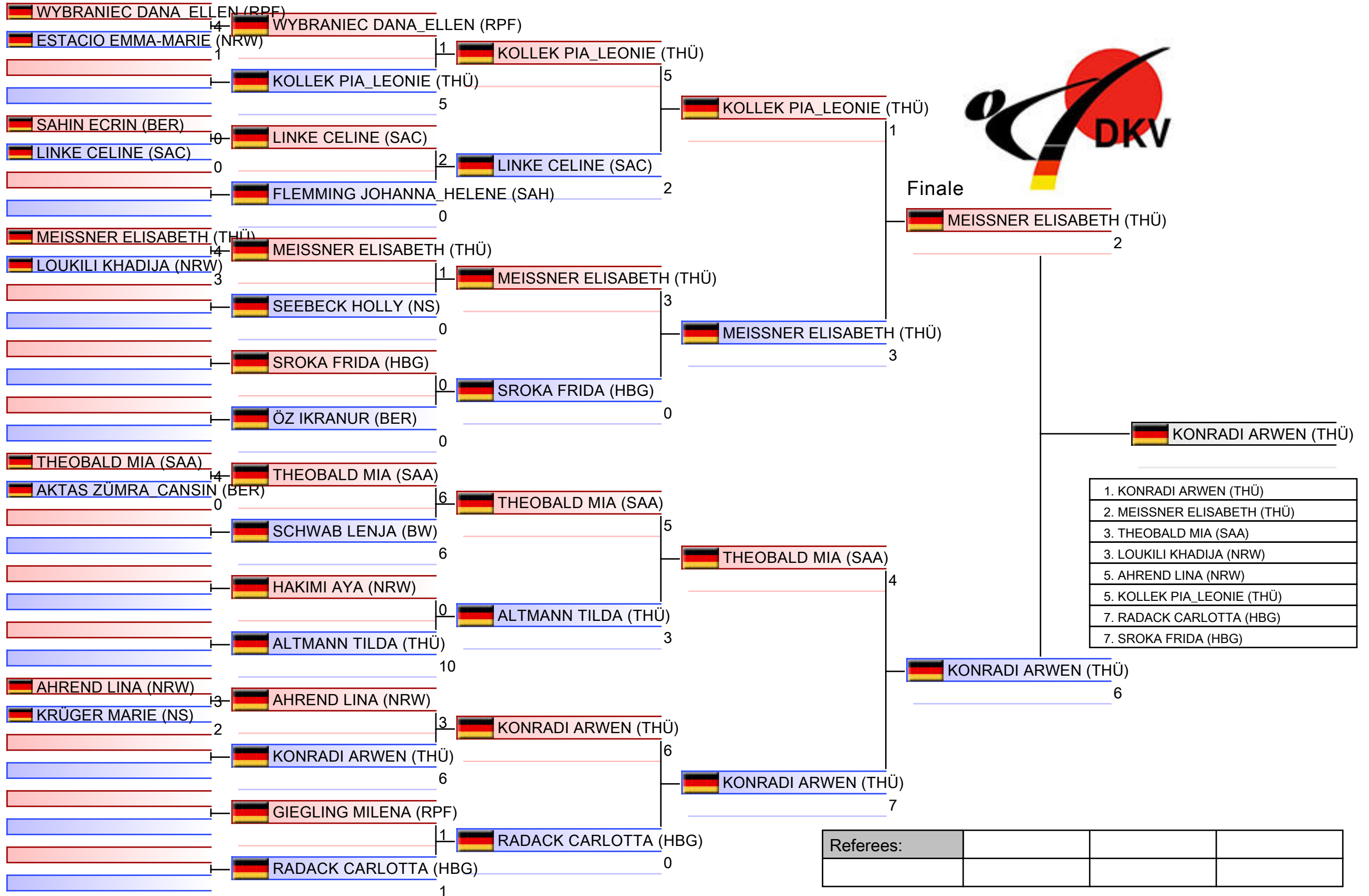

# Schüler B Kumite Einzel Mädchen +36 kg

Deutsche Meisterschaft der Schüler 2021

Tatami  
6 12:55

Pool  
1

(c)sportdata GmbH & Co KG 2000-2021(2021-09-19 22:28) -WKF Approved- v 9.8.8 build 1 (2021-07-19) Lizenz: SDIL Sportdata Internal License 2021 (expire 2021-12-31)

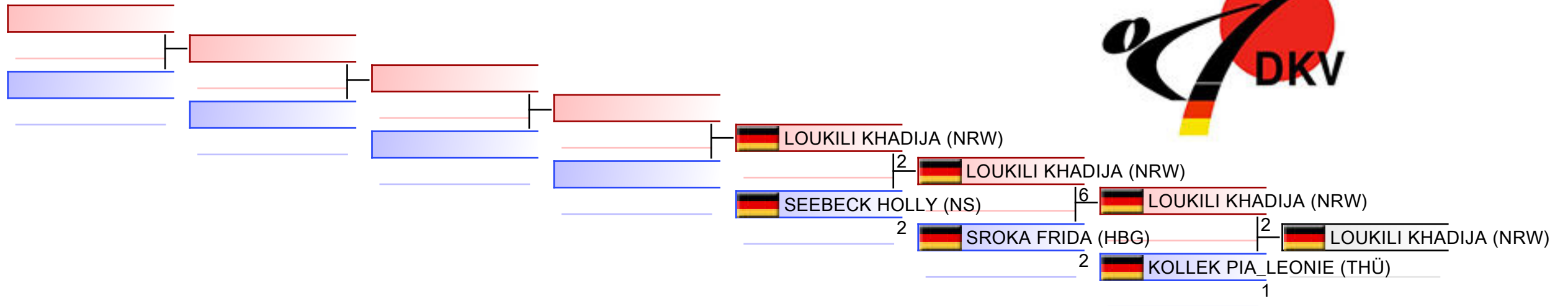



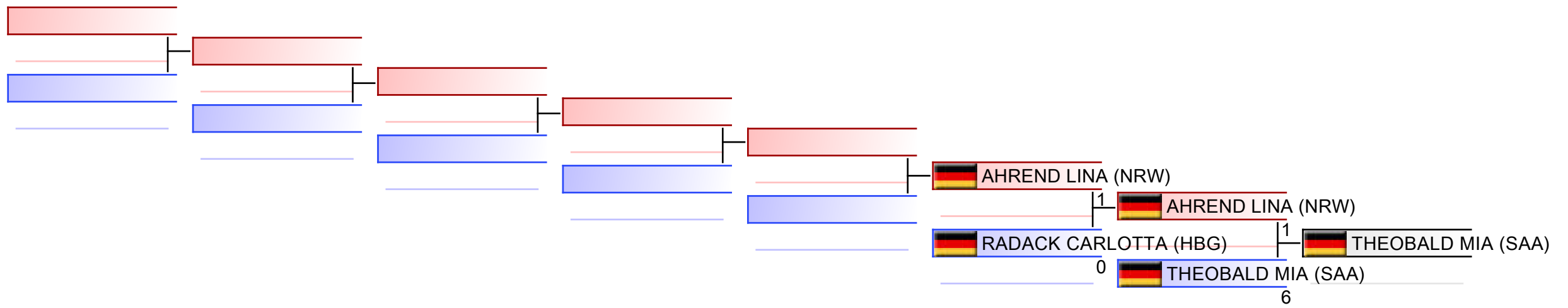





















## TROSTRUNDE: (1)



























Referees:							
-----------	--	--	--	--	--	--	--

Offizielle Ergebnisliste

Schüler A Kata Einzel Jungen				
1	MINOR DANIEL	TUS FEUCHTWANGEN ABT. KARATE		GER - GERMANY
2	STAPEL DAVID	TSG 1885 NEU ISENBURG E.V.		GER - GERMANY
3	ALBIEN ALEXANDER	TUS HUCHTING V. 1904 E. V. - ABT. KARATE		GER - GERMANY
3	PFANNENSTIEL ASIM	SFL - BREMERHAVEN E.V.		GER - GERMANY
5	GRÖPPER LEON	BUDO-SPORT- CENTER OBERHAUSEN 1977 E.V.		GER - GERMANY
5	KÖCHER MIKA	SKA AKADEMIE SAARPFALZ E.V.		GER - GERMANY
7	STENSCHKE MALCOLM	POST SV BAMBERG		GER - GERMANY
7	MEIER MIGUEL	USC-DUISBURG		GER - GERMANY
9	JAHNSMÜLLER ADRIAN	YAMAKAWA KARATE - DO BALLESTEDT E.V.		GER - GERMANY
9	KUNIYASU HARUAKI	LV_BERLIN		GER - GERMANY
11	REIM NICO	USV ERFURT E.V.		GER - GERMANY
11	MOHR JAN	TUS FEUCHTWANGEN ABT. KARATE		GER - GERMANY
13	KUMPFERT LUKAS	BLACK LION SHOTOKAN KARATE KÖLN E.V.		GER - GERMANY
13	SPIES MAARTEN	TSG 1885 NEU ISENBURG E.V.		GER - GERMANY
15	HORN DOMINIK	LV_BERLIN		GER - GERMANY
15	SEISE FABIAN	USV ERFURT E.V.		GER - GERMANY
17	BRACHER JOEL	MTV 1846 E.V. LUDWIGSBURG		GER - GERMANY
17	ALF JIM	KARATE DOJO KAZUYA SASBACH E.V.		GER - GERMANY
17	BÖHM LOUIS	GOJU-RYU SCHIFFERSTADT E. V.		GER - GERMANY
17	BÖHM MIKA	GOJU-RYU SCHIFFERSTADT E. V.		GER - GERMANY
21	KOCH ALEXANDER	KARATE-VEREIN- BUDOKAN KAISERSLAUTERN E.V.		GER - GERMANY
21	LEHMANN FELIX	FUJI YAMA ECKERNFÖRDE		GER - GERMANY
21	LÜNEBURG LINUS	SC ALSTERTAL- LANGENHORN E.V.		GER - GERMANY

Schüler A Kata Einzel Mädchen				
1	LEGLER JULIA	ASIA SPORTS WALDKRAIBURG E.V.		GER - GERMANY









Offizielle Ergebnisliste

2	LÜCK ALYSSA LILLY	KARATE SCHULE NIPPON BREMERHAVEN E.V.		GER - GERMANY	
3	SIEBERT RONJA	OKINAWA KARATE TUS ALZTAL GARCHING		GER - GERMANY	
3	RIPS MAILIN	KAITEN BEDBURG- HAU E.V.		GER - GERMANY	
5	BOBBERT AITANA	TSV 1862 ERDING E.V.		GER - GERMANY	
5	GUTZEIT NELLY	KARATE-DO SÜDBADEN		GER - GERMANY	
7	STEVENS CLAIRE	JUDOKAN FRANKFURT-BUDO- CENTER		GER - GERMANY	
7	WINSTEL NELE	1. SHOTOKAN- KARATE-VEREIN SPEYER		GER - GERMANY	
9	DREWES LEYLA-ORCHIDEA	SHOTOKAN BRAUNSCHWEIG I		GER - GERMANY	
9	SCHMIDT KLARA JOHANNA	EIMSBÜTTELER T V E.V.		GER - GERMANY	
11	POH NADINE SOPHIE	KARATE-VEREIN- BUDOKAN KAISERSLAUTERN E.V		GER - GERMANY	
11	KÜSTERS FRIDA	TURN- U. SPORTVEREIN ERKRATH 1930 E.V.		GER - GERMANY	
13	KESTANE TALIA	BUDO-SPORT- CENTER OBERHAUSEN 1977 E.V.		GER - GERMANY	
13	GALLERT LILLI	KARATE DOJO KAZUYA SASBACH E.V.		GER - GERMANY	
15	KOLLMANN MARA	YAMAKAWA KARATE - DO BALLESTEDT E.V.		GER - GERMANY	
15	GEBAUER LISA	SV GENDORF BURGKIRCHEN E.V.		GER - GERMANY	
17	HABERLAND PIA	USV ERFURT E.V.		GER - GERMANY	
17	TAHIRI NADA	USC-DUISBURG		GER - GERMANY	
17	STROH VENERA	GOJU-RYU SCHIFFERSTADT E. V.		GER - GERMANY	
17	DRISSEN ELSA	USV ERFURT E.V.		GER - GERMANY	
21	BASLER LAURA	KARATE DOJO KAZUYA SASBACH E.V.		GER - GERMANY	
21	DALINGE LILOU	SC ALSTERTAL- LANGENHORN E.V.		GER - GERMANY	
21	REICHEL ANNA	SV GRÜN-WEISS FULDA 1953 E.V.		GER - GERMANY	
21	WEIKERT JOSEPHIN	1. KARATE-DO EGELN		GER - GERMANY	
25	SCHUBERT ALICIA	CHEMNITZER FREIZEIT-U. WOHNGEBIETSSPORTVEREIN		GER - GERMANY	

## Offizielle Ergebnisliste

25	SORA LIANE	BUDO CLUB RHEIN-NECKAR E.V.		GER - GERMANY	
----	------------	-----------------------------	---	---------------	--

### Schüler A Kumite Einzel Mädchen -38 kg

1	DREHMANN EMILY-CHIARA	SEI-WA-KAI MEISSEN E.V.		GER - GERMANY	
2	WICKLEIN AMY	NIPPON GOTHA E.V.		GER - GERMANY	
3	BRETTNACHER MIA	TEAM FIGHTCLUB WESTERWALD E.V.		GER - GERMANY	
3	HOHEISEL PAULA	TEAM FIGHTCLUB WESTERWALD E.V.		GER - GERMANY	
5	BRADEL STELLA	HARBURGER TURNERBUND V. 1865 E.V.		GER - GERMANY	
5	RUPPEL MARIA	SV HERKULES 01 KASSEL E.V.		GER - GERMANY	
7	GEBAUER LISA	SV GENDORF BURGKIRCHEN E.V.		GER - GERMANY	
7	WOLF NICOLE	KARATE CENTRUM HERSBRUCK E.V.		GER - GERMANY	
9	SPINDLER MARIE	KARATE DOJO KEMPEN E.V.		GER - GERMANY	

### Schüler A Kumite Einzel Jungen +49 kg

1	BRÜCKNER MALTE	SPORT-U. KARATESCHULE STASSFURT E.V.		GER - GERMANY	
2	JÜNEMANN LINUS	KEN BUDO HEILIGENSTADT E.V.		GER - GERMANY	
3	AZADI JAHAN	KARATE ACADEMY E.V.		GER - GERMANY	
3	HERZOG WILHELM	SEI-WA-KAI MEISSEN E.V.		GER - GERMANY	
5	SCHMELING NILS	SKIP SYKE E.V.		GER - GERMANY	
5	SCHWARZBECK NICK MARLO	KARATE DOJO BUSHIDO HEILBRONN E.V.		GER - GERMANY	
7	MEIER MIGUEL	USC-DUISBURG		GER - GERMANY	
7	KURZ PHIL	TEAM FIGHTCLUB WESTERWALD E.V.		GER - GERMANY	
9	STECKER ILJA	SSV NÜBBEL		GER - GERMANY	
9	BRACHER JOEL	MTV 1846 E.V. LUDWIGSBURG		GER - GERMANY	

### Schüler A Kumite Einzel Jungen -38 kg

1	NAMYSLIK FELIX	SEI-WA-KAI MEISSEN E.V.		GER - GERMANY	
2	HERTRICH LUIS	KARATE DOJO NAILA		GER - GERMANY	
3	PFEIFFER FABIAN	TUS HUCHTING V. 1904 E. V. - ABT. KARATE		GER - GERMANY	
3	FRIEDEL MORITZ	GOJU-KAI AMTSBERG E.V.		GER - GERMANY	
5	VOGL SIMON	KARATE-DOJO BURGLENGENFELD		GER - GERMANY	
5	BIERMANN ALEXANDER	SHUKOKAI KARATE WANDLITZ E.V.		GER - GERMANY	

## Offizielle Ergebnisliste

7	BECKER YANNIK	KARATE TEAM KSC PUDERBACH		GER - GERMANY	
7	TSCHUMAROW ANDREJ	TEAM FIGHTCLUB WESTERWALD E.V.		GER - GERMANY	

### Schüler A Kumite Einzel Jungen -44 kg

1	ALTKEMPER SAM	BUDOKAN BOCHUM E.V.		GER - GERMANY	
2	KALIES TOM	KARATEVEREIN NORDHORN E.V.		GER - GERMANY	
3	BECKER FINLEY	KARATE TEAM KSC PUDERBACH		GER - GERMANY	
3	MOJSOVSKI MIKA	BUDOKAN BOCHUM E.V.		GER - GERMANY	
5	CHATAEV ISLAM ADAM	TSV REINBEK - ABT. KARATE		GER - GERMANY	
5	WELTER LOUIS	KARATE- UND SPORTVEREIN TRIER E.V.		GER - GERMANY	
7	JÄGER MORITZ	KARATE-DO ROCHLITZ E.V.		GER - GERMANY	
7	BIELICH FREDERIK	TSV REINBEK - ABT. KARATE		GER - GERMANY	
9	MIHAJLOVIC ANDREJ	KARATE U. JUDO- CLUB RAVENSBURG E. V.		GER - GERMANY	

### Schüler A Kumite Einzel Jungen -49 kg

1	OSWALD JAN	1. BRANDENBURGER KAMPFSportVEREIN		GER - GERMANY	
2	MÜLLER MARIUS	KARATE ACADEMY E.V.		GER - GERMANY	
3	BEIRIT EDGAR	BUDOKAN BOCHUM E.V.		GER - GERMANY	
3	SCHOKNECHT JAN JASPER	BUSHIDO VERDEN E.V.		GER - GERMANY	
5	FAHRENBRUCH JEAN LUIS	TEAM FIGHTCLUB WESTERWALD E.V.		GER - GERMANY	
5	AYDOGDU DIJAR	USC-DUISBURG		GER - GERMANY	
7	KÖCHER MIKA	SKA AKADEMIE SAARPFALZ E.V.		GER - GERMANY	
7	SALJIC SEMIN	KARATE DOJO OKI BAYERN		GER - GERMANY	

### Schüler A Kumite Einzel Mädchen +49 kg

1	HERARI ELISABETH	USC-DUISBURG		GER - GERMANY	
2	WEISS JAMILA	KEN BUDO HEILIGENSTADT E.V.		GER - GERMANY	
3	DAWAUD DALIA	KD CHIKARA-CLUB ERFURT E.V.		GER - GERMANY	
3	HEINRICH ALINA	GOJU-RYU KARATE VEREIN GARATH E.V.		GER - GERMANY	
5	RAUSCH LISA	TEAM FIGHTCLUB WESTERWALD E.V.		GER - GERMANY	
5	SCHWAB LAURA	KARATE CENTRUM RHEIN-NECKAR E.V.		GER - GERMANY	
7	GÜRKAN ECRIN	SC BANZAI BERLIN		GER - GERMANY	

## Offizielle Ergebnisliste

7	SCHNABEL MIRA	1. KARATE DOJO UNTERMERZBACH 1975 E. V.		GER - GERMANY	
9	SCHEIDTMANN MAJA	TSV REINBEK - ABT. KARATE		GER - GERMANY	

**Schüler A Kumite Einzel Mädchen -44 kg**

1	HELLEN ILI	SEN5 KARATE E.V.		GER - GERMANY	
2	HAMZAH AMIRA	MTV 1846 E.V. LUDWIGSBURG		GER - GERMANY	
3	LOWRY LIVIA JADE	1. SHOTOKAN- KARATE-ZENTRUM FORCHHEIM E.V.		GER - GERMANY	
3	MATTYS MELINA	NIPPON GOTHA E.V.		GER - GERMANY	
5	MEIER EMILY	BUSHIDO VERDEN E.V.		GER - GERMANY	
5	KÖNIG LIV SVENDE	SPORTCENTER BUSHIDO WALTERSHAUSEN		GER - GERMANY	
7	FISCHER EMINA	DRESDNER KARATE TEAM E.V.		GER - GERMANY	
7	HEINRICH ELENOR	SEI-WA-KAI MEISSEN E.V.		GER - GERMANY	
9	SAFI MALLAK	FUNAKOSHI KARATE NORTHEIM E. V.		GER - GERMANY	

**Schüler A Kumite Einzel Mädchen -49 kg**













1	SCHMITZ CELINE	KD CHIKARA-CLUB ERFURT E.V.		GER - GERMANY	
2	SCHMITZ JOSIE	KD CHIKARA-CLUB ERFURT E.V.		GER - GERMANY	
3	SCHINDLER MILEY	KC BUSHIDO BONN		GER - GERMANY	
3	HERING ALIA	TEAM FIGHTCLUB WESTERWALD E.V.		GER - GERMANY	
5	KOSTBAR EVELYN SOPHIE	KARATE U. JUDO- CLUB RAVENSBURG E. V.		GER - GERMANY	
5	PERDIKI DAMIANA	SATORI SOLINGEN E.V.		GER - GERMANY	
7	BAND ANNA-LENA	HARBURGER TURNERBUND V. 1865 E.V.		GER - GERMANY	
7	DRESSLER LILLI	ASIA SPORTS WALDKRAIBURG E.V.		GER - GERMANY	

**Schüler B Kata Einzel Jungen**

1	ELKAIEM MOHAMED	BLACK LION SHOTOKAN KARATE KÖLN E.V.		GER - GERMANY	
2	JASON RICHTER	SHOTOKAN KARATE DOJO SATORI HILDEN E.V.		GER - GERMANY	
3	KUNIYASU SHOUTA	LV_BERLIN		GER - GERMANY	
3	ILLI DANIIL	LV_BERLIN		GER - GERMANY	
5	IOANNIS NIKOLAIDIS	SHOTOKAN KARATE DOJO SATORI HILDEN E.V.		GER - GERMANY	



## Offizielle Ergebnisliste

5	BALLEWSKI MORITZ	KD CHIKARA-CLUB ERFURT E.V.		GER - GERMANY	
7	BOLAND BAKHSH ARIAN	SHOTOKAN RYU KARATE DO AKADEMIE E.V. RÜLZHEIM		GER - GERMANY	
7	PFEIL MARLO	USV ERFURT E.V.		GER - GERMANY	
9	ANNAFIA MOHAMED NOUR	USC-DUISBURG		GER - GERMANY	
9	AETHNER RUBEN	SFL - BREMERHAVEN E.V.		GER - GERMANY	
11	KISTNER ANDREJ	MTV 1846 E.V. LUDWIGSBURG		GER - GERMANY	
11	BÜCKERT JONAS	KD CHIKARA-CLUB ERFURT E.V.		GER - GERMANY	
13	PIRES VICTOR TSOY SIMOES	DOKAN BERLIN		GER - GERMANY	
13	VÖLKER JOHN	1. SHOTOKAN- KARATE-VEREIN SPEYER		GER - GERMANY	
15	FRASCH VIKTOR	SFL - BREMERHAVEN E.V.		GER - GERMANY	
15	SABANOVIC OMER	KARATE DOJO OKI BAYERN		GER - GERMANY	
17	POISEL LUDWIG	TSV MONHEIM E.V.		GER - GERMANY	
19	SABANOVIC SAID	KARATE DOJO OKI BAYERN		GER - GERMANY	

### Schüler B Kata Einzel Mädchen

1	BIDEMANN HANNAH	TSG ESSLINGEN		GER - GERMANY	
2	ISKANDARYAN ANNE-MARIE	1. SHOTOKAN KARATE CLUB FRANKENTHAL		GER - GERMANY	
3	BIDEMANN GRETA	TSG ESSLINGEN		GER - GERMANY	
3	SCHAUDIG LUISA	1. SHOTOKAN KARATE CLUB FRANKENTHAL		GER - GERMANY	
5	LIPPERT HELENA	USV ERFURT E.V.		GER - GERMANY	
5	RÖDER LUISE	KD CHIKARA-CLUB ERFURT E.V.		GER - GERMANY	
7	GRUBER DARIA	BUSHIDO POTSDAM E.V.		GER - GERMANY	
7	LÄNGERER STELLA	SHODUSHI GARREL E.V.		GER - GERMANY	
9	LÄNGERER LAETIZIA	SHODUSHI GARREL E.V.		GER - GERMANY	
9	BIYIK ECRIN	GOJU-RYU KARATE VEREIN GARATH E.V.		GER - GERMANY	
11	ASSMANN LINNEA	YAMAKAWA KARATE - DO BALLENSTEDT E.V.		GER - GERMANY	
11	GOETHE MARIEL	BUDO CLUB RHEIN- NECKAR E.V.		GER - GERMANY	
13	UCAR BESIME FIDANZIA	SHOTOKAN KARATE DOJO SATORI HILDEN E.V.		GER - GERMANY	
13	BONITZ SOPHIA	CHEMNITZER FREIZEIT-U. WOHNGBIETSSPORTVEREIN		GER - GERMANY	

## Offizielle Ergebnisliste

15	TANK VANESSA	BUDO-SPORT-CENTER OBERHAUSEN 1977 E.V.		GER - GERMANY	
15	FEYGIN EMILY	BUDOKAN BOCHUM E.V.		GER - GERMANY	
17	WIENBECK RANI	SFL - BREMERHAVEN E.V.		GER - GERMANY	
17	HUBRICH TALIA	DOKAN BERLIN		GER - GERMANY	
17	MÜLLER SARAH	TSV MONHEIM E.V.		GER - GERMANY	
17	BELZ AILA	KARATE DOJO KAZUYA SASBACH E.V.		GER - GERMANY	
21	WALTHER MATHILDA	USV ERFURT E.V.		GER - GERMANY	
21	EHLING MAGDALENA	ASIA SPORTS WALDKRAIBURG E.V.		GER - GERMANY	
21	LAMPERSBERGER EMILIA	TSV GRABENSTÄTT - CHIEMSEE E.V.		GER - GERMANY	
25	BESANCON JOEL JOSEPHINE	KARATEVEREIN BUDOKAN MAGDEBURG		GER - GERMANY	

### Schüler B Kumite Einzel Jungen +38 kg

1	NAHRMANN MATTIS	SKIP SYKE E.V.		GER - GERMANY	
2	ABO MOHAMAD	BUDOKAN BOCHUM E.V.		GER - GERMANY	
3	RUHMANN MAX	SHOTOKAN KARATE SAARWELLINGEN E.V.		GER - GERMANY	
3	GRÄFE LUKAS	SEI-WA-KAI MEISSEN E.V.		GER - GERMANY	
5	RHEIN DAVID	SV HERKULES 01 KASSEL E.V.		GER - GERMANY	
5	ARBIB ANAS	1. KÖLNER KARATE CLUB BUSHIDO E.V.		GER - GERMANY	
7	ROSSMANN LEON	TSV MONHEIM E.V.		GER - GERMANY	
7	JANOTT ELIAS	KD CHIKARA-CLUB ERFURT E.V.		GER - GERMANY	
9	SCHMIDTGEN MAURICE RAVEL	SEI-WA-KAI MEISSEN E.V.		GER - GERMANY	

### Schüler B Kumite Einzel Jungen -32 kg

1	KISTNER ANDREJ	MTV 1846 E.V. LUDWIGSBURG		GER - GERMANY	
2	FICHELTMANN ERIC	BANZAI-KARATE E.T. HIRSCHBERG-SAALE		GER - GERMANY	
3	STAUFFENBERG FRIEDOLIN	TAO TE WEIMARER LAND E.V.		GER - GERMANY	
3	DORNSEIFER TIANBAI DOMINIK	1. KÖLNER KARATE CLUB BUSHIDO E.V.		GER - GERMANY	
5	PIRES VICTOR TSOY SIMOES	DOKAN BERLIN		GER - GERMANY	
5	LEHMANN KEVIN	KARATE U. JUDO-CLUB RAVENSBURG E. V.		GER - GERMANY	
7	DEEV MIKHAIL	FUNAKOSHI KARATE NORTHEIM E. V.		GER - GERMANY	
7	LUKASHEVICH NIKITA	DOJO LEMGO-LIPPE E.V.		GER - GERMANY	

## Offizielle Ergebnisliste

Schüler B Kumite Einzel Jungen -38 kg					
1	GRÜNELT OLIVER	SEI-WA-KAI MEISSEN E.V.		GER - GERMANY	
2	CASTELLS LENNART	SV CURSLACK-NEUENGAMME V. 1919 E.V.		GER - GERMANY	
3	SWIDERSKY BEN	KARATE TEAM KSC PUDERBACH		GER - GERMANY	
3	EHRENBERG JONAS	SPORTCENTER BUSHIDO WALTERSHAUSEN		GER - GERMANY	
5	NAGY TRISTAN	KARATE-DOJO MUTTERSTADT E.V.		GER - GERMANY	
5	PETRI MATS	KARATE DOJO KEMPEN E.V.		GER - GERMANY	
7	MORINA ARTION	KARATE SPORT-CENTER FREUDENSTADT		GER - GERMANY	
7	HANSEMANN MARLON	MTV 1846 E.V. LUDWIGSBURG		GER - GERMANY	
9	FAJARDO DAVIO	RHEIN BERG KARATE BERGISCH GLADBACH E.V.		GER - GERMANY	



























Schüler B Kumite Einzel Mädchen +36 kg					
1	KONRADI ARWEN	TAO TE WEIMARER LAND E.V.		GER - GERMANY	
2	MEISSNER ELISABETH	TAO TE WEIMARER LAND E.V.		GER - GERMANY	
3	THEOBALD MIA	SHOTOKAN KARATE SAARWELLINGEN E.V.		GER - GERMANY	
3	LOUKILI KHADIJA	1. KÖLNER KARATE CLUB BUSHIDO E.V.		GER - GERMANY	
5	AHREND LINA	RHEIN BERG KARATE BERGISCH GLADBACH E.V.		GER - GERMANY	
5	KOLLEK PIA LEONIE	SPORTCENTER BUSHIDO WALTERSHAUSEN		GER - GERMANY	
7	RADACK CARLOTTA	SV CURSLACK-NEUENGAMME V. 1919 E.V.		GER - GERMANY	
7	SROKA FRIDA	SV CURSLACK-NEUENGAMME V. 1919 E.V.		GER - GERMANY	
9	SEEBECK HOLLY	BUSHIDO VERDEN E.V.		GER - GERMANY	

Schüler B Kumite Einzel Mädchen -30 kg					
1	SAFI DANIA	FUNAKOSHI KARATE NORTHEIM E. V.		GER - GERMANY	
2	GRÖGER VANESSA	SPORTCENTER BUSHIDO WALTERSHAUSEN		GER - GERMANY	
3	HANERT DIANA	KARATE SCHULE NIPPON BREMERHAVEN E.V.		GER - GERMANY	
5	NESTLER JOHANNA	KD CHIKARA-CLUB ERFURT E.V.		GER - GERMANY	













Offizielle Ergebnisliste

Schüler B Kumite Einzel Mädchen -36 kg				
1	RÖDER LUISE	KD CHIKARA-CLUB ERFURT E.V.		GER - GERMANY
2	OLSCHEWSKI HANNA	SPORT-U. KARATESCHULE STASSFURT E.V.		GER - GERMANY
3	BRETTNACHER JULIE	TEAM FIGHTCLUB WESTERWALD E.V.		GER - GERMANY
3	WIENBECK RANI	SFL - BREMERHAVEN E.V.		GER - GERMANY
5	BAUMGÄRTNER LARA	TEAM FIGHTCLUB WESTERWALD E.V.		GER - GERMANY
5	PAULUS CHAYENNE	SHOTOKAN KARATE SAARWELLINGEN E.V.		GER - GERMANY
7	EHLING ISABELLA	ASIA SPORTS WALDKRAIBURG E.V.		GER - GERMANY
7	STAUDT SAMIRA	TEAM FIGHTCLUB WESTERWALD E.V.		GER - GERMANY
9	KAPPEL FINJA	KARATEVEREIN NORDHORN E.V.		GER - GERMANY
9	MEYEN SELDA	NIPPON GOTHA E.V.		GER - GERMANY





















Medaillenspiegel - Verein

Rang	Verein	1. Platz	2. Platz	3. Platz	5. Platz	7. Platz
1	 SEI-WA-KAI MEISSEN E.V., GER	3	0	2	0	1
2	 KD CHIKARA-CLUB ERFURT E.V., GER	2	1	1	3	1
3	 BUDOKAN BOCHUM E.V., GER	1	1	2	0	0
4	 TAO TE WEIMARER LAND E.V., GER	1	1	1	0	0
5	 MTV 1846 E.V. LUDWIGSBURG, GER	1	1	0	0	1
6	 SPORT-U. KARATESCHULE STASSFURT E.V., GER	1	1	0	0	0
7	 TSG ESSLINGEN, GER	1	0	1	0	0
8	 USC-DUISBURG, GER	1	0	0	1	2
9	 SKIP SYKE E.V., GER	1	0	0	1	0
10	 ASIA SPORTS WALDKRAIBURG E.V., GER	1	0	0	0	2
11	 FUNAKOSHI KARATE NORTHEIM E. V., GER	1	0	0	0	1
12	 BLACK LION SHOTOKAN KARATE KÖLN E.V., GER	1	0	0	0	0
	 TUS FEUCHTWANGEN ABT. KARATE, GER	1	0	0	0	0
	 SEN5 KARATE E.V., GER	1	0	0	0	0
	 1. BRANDENBURGER KAMPFSportVEREIN, GER	1	0	0	0	0
16	 KEN BUDO HEILIGENSTADT E.V., GER	0	2	0	0	0
17	 SPORTCENTER BUSHIDO WALTERSHAUSEN, GER	0	1	1	2	0
18	 KARATE ACADEMY E.V., GER	0	1	1	0	0
	 1. SHOTOKAN KARATE CLUB FRANKENTHAL, GER	0	1	1	0	0
	 KARATE SCHULE NIPPON BREMERHAVEN E.V., GER	0	1	1	0	0
	 NIPPON GOTHA E.V., GER	0	1	1	0	0
22	 SHOTOKAN KARATE DOJO SATORI HILDEN E.V., GER	0	1	0	1	0
23	 SV CURSLACK-NEUENGAMME V. 1919 E.V., GER	0	1	0	0	2
24	 BANZAI-KARATE E.T. HIRSCHBERG-SAALE, GER	0	1	0	0	0
	 KARATE DOJO NAILA, GER	0	1	0	0	0
	 TSG 1885 NEU ISENBURG E.V., GER	0	1	0	0	0
	 KARATEVEREIN NORDHORN E.V., GER	0	1	0	0	0

### Medaillenspiegel - Verein















28	 TEAM FIGHTCLUB WESTERWALD E.V., GER	0	0	4	3	3
29	 SHOTOKAN KARATE SAARWELLINGEN E.V, GER	0	0	2	1	0
	 1. KÖLNER KARATE CLUB BUSHIDO E.V., GER	0	0	2	1	0
31	 KARATE TEAM KSC PUDERBACH, GER	0	0	2	0	1
32	 LV_BERLIN, GER	0	0	2	0	0
	 SFL - BREMERHAVEN E.V., GER	0	0	2	0	0
	 TUS HUCHTING V. 1904 E. V. - ABT. KARATE, GER	0	0	2	0	0
35	 BUSHIDO VERDEN E.V., GER	0	0	1	1	0
36	 KC BUSHIDO BONN, GER	0	0	1	0	0
	 GOJU-RYU KARATE VEREIN GARATH E.V, GER	0	0	1	0	0
	 OKINAWA KARATE TUS ALZTAL GARCHING, GER	0	0	1	0	0
	 KAITEN BEDBURG-HAU E.V., GER	0	0	1	0	0
	 1. SHOTOKAN-KARATE-ZENTRUM FORCHHEIM E.V., GER	0	0	1	0	0
	 GOJU-KAI AMTSBERG E.V., GER	0	0	1	0	0
42	 KARATE U. JUDO-CLUB RAVENSBURG E. V., GER	0	0	0	2	0
	 SV HERKULES 01 KASSEL E.V., GER	0	0	0	2	0
44	 HARBURGER TURNERBUND V. 1865 E.V., GER	0	0	0	1	1
	 TSV REINBEK - ABT. KARATE, GER	0	0	0	1	1
	 SKA AKADEMIE SAARPFALZ E.V., GER	0	0	0	1	1
	 USV ERFURT E.V., GER	0	0	0	1	1
48	 TSV 1862 ERDING E.V., GER	0	0	0	1	0
	 KARATE- UND SPORTVEREIN TRIER E.V., GER	0	0	0	1	0
	 KARATE-DOJO BURGLENGENFELD, GER	0	0	0	1	0
	 SHUKOKAI KARATE WANDLITZ E.V., GER	0	0	0	1	0
	 KARATE-DO SÜDBADEN, GER	0	0	0	1	0
	 SATORI SOLINGEN E.V., GER	0	0	0	1	0
	 KARATE DOJO BUSHIDO HEILBRONN E.V., GER	0	0	0	1	0
	 DOKAN BERLIN, GER	0	0	0	1	0

Medaillenspiegel - Verein

	 KARATE CENTRUM RHEIN-NECKAR E.V., GER	0	0	0	1	0
	 BUDO-SPORT-CENTER OBERHAUSEN 1977 E.V., GER	0	0	0	1	0
	 KARATE-DOJO MUTTERSTADT E.V., GER	0	0	0	1	0
	 KARATE DOJO KEMPEN E.V., GER	0	0	0	1	0
	 RHEIN BERG KARATE BERGISCH GLADBACH E.V., GER	0	0	0	1	0
61	 KARATE DOJO OKI BAYERN, GER	0	0	0	0	1
	 BUSHIDO POTSDAM E.V., GER	0	0	0	0	1
	 SHODUSHI GARREL E.V., GER	0	0	0	0	1
	 DRESDNER KARATE TEAM E.V., GER	0	0	0	0	1
	 POST SV BAMBERG, GER	0	0	0	0	1
	 TSV MONHEIM E.V., GER	0	0	0	0	1
	 JUDOKAN FRANKFURT-BUDO-CENTER, GER	0	0	0	0	1
	 SV GENDORF BURGKIRCHEN E.V., GER	0	0	0	0	1
	 SC BANZAI BERLIN, GER	0	0	0	0	1
	 1. KARATE DOJO UNTERMERZBACH 1975 E. V., GER	0	0	0	0	1
	 DOJO LEMGO-LIPPE E.V., GER	0	0	0	0	1
	 KARATE-DO ROCHLITZ E.V., GER	0	0	0	0	1
	 SHOTOKAN RYU KARATE DO AKADEMIE E.V. RÜLZHEIM, GER	0	0	0	0	1
	 KARATE CENTRUM HERSBRUCK E.V., GER	0	0	0	0	1
	 KARATE SPORT-CENTER FREUDENSTADT, GER	0	0	0	0	1
	 1. SHOTOKAN-KARATE-VEREIN SPEYER, GER	0	0	0	0	1

## Deutsche Meisterschaft der Schüler 2021 - 2021-09-19

### Medaillenspiegel - Landesverband / Region

Rang	Landesverband / Region	1. Platz	2. Platz	3. Platz	5. Platz	7. Platz
1	 Thüringen, THÜ, GER	3	7	4	6	2
2	 Nordrhein Westfalen, NRW, GER	3	2	7	7	3
3	 Sachsen, SAC, GER	3	0	3	0	3
4	 Bayern, BAY, GER	2	1	2	2	8
5	 Baden-Württemberg, BW, GER	2	1	1	5	2
6	 Niedersachsen, NS, GER	2	1	1	2	2
7	 Rheinland Pfalz, RPF, GER	1	1	7	5	6
8	 Sachsen-Anhalt, SAH, GER	1	1	0	0	0
9	 Brandenburg, BRA, GER	1	0	0	1	1
10	 Hamburg, HBG, GER	0	2	1	1	3
11	 Bremen, BRE, GER	0	1	5	0	0
12	 Hessen, HES, GER	0	1	0	2	1
13	 Saarland, SAA, GER	0	0	2	2	1
14	 Berlin, BER, GER	0	0	2	1	1
15	 Schleswig-Holstein, SH, GER	0	0	0	1	1