

# Karate1 Youth League - Acapulco 2022

2022.01.21 - 2022.01.23

Acapulco

MEXICO,MEX





# Karate1 Youth League - Acapulco 2022

MEXICO  
Acapulco

2022.01.21 - 2022.01.23

## NUMBER OF ENTRIES

#	Code	Country	Male Entries	Female Entries	Total Entries	Total Athletes
1	ARG	ARGENTINA	2	0	2	1
2	BEL	BELGIUM	2	2	4	4
3	BRA	BRAZIL	1	0	1	1
4	CAN	CANADA	5	2	7	6
5	CHI	CHILE	3	5	8	8
6	COL	COLOMBIA	1	5	6	4
7	CRC	COSTA RICA	2	11	13	8
8	CRO	CROATIA	1	1	2	2
9	ECU	ECUADOR	2	2	4	3
10	ESA	EL SALVADOR	6	3	9	5
11	ENG	ENGLAND	2	4	6	5
12	FRA	FRANCE	3	2	5	5
13	GER	GERMANY	8	10	18	18
14	GUA	GUATEMALA	4	6	10	7
15	ITA	ITALY	1	1	2	2
16	MEX	MEXICO	137	97	234	205
17	NED	NETHERLANDS	1	0	1	1
18	NOR	NORWAY	2	0	2	2
19	PAN	PANAMA	4	2	6	4
20	POL	POLAND	4	3	7	7
21	POR	PORTUGAL	1	0	1	1
22	PUR	PUERTO RICO	1	1	2	2
23	ROU	ROMANIA	1	0	1	1
24	RUS	RUSSIAN FEDERATION	1	2	3	3
25	SCO	SCOTLAND	0	2	2	2
26	SLO	SLOVENIA	1	3	4	4
27	ESP	SPAIN	2	0	2	2
28	SUI	SWITZERLAND	0	1	1	1
29	USA	UNITED STATES	54	20	74	58
30	VEN	VENEZUELA	8	8	16	13
<b>Totals:</b>			260	193	453	385



# Karate1 Youth League - Acapulco 2022

MEXICO  
Acapulco

2022.01.21 - 2022.01.23

## Statistics

Participating Countries: 30

Participating Regions: 1

Participating  
Team/Clubs: 147

	Competitors	Entries
Female	164	193
Male	221	260
<b>Total</b>	<b>385</b>	<b>453</b>

### Entries per Category

	Entries	Teams
Cadet Kata Female	30	-
Cadet Kata Male	34	-
Cadet Kumite Female -47 kg	13	-
Cadet Kumite Female -54 kg	16	-
Cadet Kumite Female 54+ kg	17	-
Cadet Kumite Male -52 kg	24	-
Cadet Kumite Male -57 kg	17	-
Cadet Kumite Male -63 kg	16	-
Cadet Kumite Male -70 kg	12	-
Cadet Kumite Male 70+ kg	11	-
Junior Kata Female	30	-
Junior Kata Male	17	-
Junior Kumite Female -48 kg	7	-
Junior Kumite Female -53 kg	20	-
Junior Kumite Female -59 kg	17	-
Junior Kumite Female 59+ kg	10	-
Junior Kumite Male -55 kg	15	-
Junior Kumite Male -61 kg	23	-
Junior Kumite Male -68 kg	13	-
Junior Kumite Male -76 kg	11	-
Junior Kumite Male 76+ kg	15	-
U14 Kata Female	12	-
U14 Kata Male	16	-
U14 Kumite Female -42 kg	5	-
U14 Kumite Female -47 kg	7	-
U14 Kumite Female 47+ kg	9	-
U14 Kumite Male +55 kg	6	-
U14 Kumite Male -40 kg	8	-
U14 Kumite Male -45 kg	7	-
U14 Kumite Male -50 kg	7	-



# Karate1 Youth League - Acapulco 2022

MEXICO  
Acapulco

2022.01.21 - 2022.01.23

## Statistics

U14 Kumite Male -55 kg

8

-

<b>Totals:</b>	<b>453</b>	<b>0</b>
----------------	------------	----------



Karate1 Youth League - Acapulco 2022 - 2022-01-21  
Cadet Kata Female

R1 G1/4 (8) Tatami 1 11:50

Competitors	Kata	1T	1A	2T	2A	3T	3A	4T	4A	5T	5A	6T	6A	7T	7A	TEC	ATH	Extra	Total	Rank
1 PARRA_GRAJEDA CAMILA (MEX)	001 ANAN	6.4	6.4	(6.2)	(6.2)	6.6	6.4	(7.0)	(6.8)	7.0	6.8					14.0	5.88		19.888	
2 BUI MAI-LINH (FRA)	020 GOJUSHIHO DAI	(8.4)	(8.4)	8.0	7.8	(7.6)	7.6	7.6	(7.4)	7.8	7.6					16.38	6.9		23.281	
3 RAJNANDHINI JOANNE (CAN)	009 CHIBANA NO KUSHANKU	7.4	7.4	(7.6)	7.4	(7.2)	(7.2)	7.2	7.2	7.6	(7.6)					15.54	6.6		22.145	
4 CASILLAS_OCHOA MELISSA MONSERRAT (MEX)	083 SEIPAI	6.6	6.4	(6.4)	(6.2)	6.8	6.6	(7.0)	(6.8)	7.0	6.8					14.28	5.94		20.227	
5 NAVARRETE GABRIELA (USA)	047 KURURUNFA	(7.4)	7.6	(7.6)	(7.8)	7.4	(7.2)	7.6	7.4	7.4	7.4					15.68	6.72		22.4	4
6 SIBAJA_CASTRO MARIEDITH (CRC)	021 GOJUSHIHO SHO	6.8	(6.8)	(6.6)	6.8	(7.2)	(7.0)	7.2	7.0	7.2	7.0					14.84	6.24		21.086	
7 CASTRO TREJOS_LIZETH MANUELA (COL)	020 GOJUSHIHO DAI	(8.0)	(8.2)	7.6	7.4	(7.4)	(7.2)	7.4	7.2	7.6	7.4					15.82	6.6		22.423	
8 GALVAN_RODRIGUEZ MICHELLE (MEX)	047 KURURUNFA	(7.8)	(7.8)	7.8	7.6	(7.2)	(7.2)	7.6	7.4	7.8	7.6					16.24	6.78		23.022	

R1 G2/4 (7) Tatami 1 12:25

Competitors	Kata	1T	1A	2T	2A	3T	3A	4T	4A	5T	5A	6T	6A	7T	7A	TEC	ATH	Extra	Total	Rank
1 HERRERA_CASTRO ERICKA SUZETHE (MEX)	001 ANAN	7.6	7.6	7.4	7.4	(7.2)	(7.0)	7.4	7.2	(7.8)	(7.8)					15.68	6.66		22.343	
2 OLIGINO DIANA (VEN)	099 UNSU	(8.4)	(8.6)	7.8	8.0	(7.4)	(7.4)	7.6	7.6	8.0	7.8					16.38	7.02		23.4	1
3 BELTRAN_CERVANTES MERARY_ALEJANDRA (MEX)																				
4 ALVARADO_PORRAS ANA MARIA (CRC)	020 GOJUSHIHO DAI	(7.6)	(7.4)	7.0	(6.8)	(6.8)	6.8	7.2	7.2	7.2	7.2					14.98	6.36		21.344	
5 CHU JADE LI-YA MISAKI (USA)	002 ANAN DAI	(7.8)	(8.0)	7.8	7.6	(7.4)	7.4	7.4	(7.2)	7.4	7.2					15.82	6.66		22.482	
6 LEVY_HARARI ANDREA (MEX)	008 CHATANYARA KUSHANKU	(6.4)	6.4	6.6	(6.2)	6.8	6.6	6.8	6.6	(7.2)	(7.2)					14.14	5.88		20.026	
7 VELIZ_RODRIGUEZ KARIN MARIANA (GUA)	030 HEIKU	6.6	(6.4)	(6.2)	6.4	6.6	6.4	(7.2)	(7.0)	7.2	7.0					14.28	5.94		20.225	

R1 G3/4 (8) Tatami 2 11:50

Competitors	Kata	1T	1A	2T	2A	3T	3A	4T	4A	5T	5A	6T	6A	7T	7A	TEC	ATH	Extra	Total	Rank
1 AGUILAR_CRUZ NICOLE (ECU)	021 GOJUSHIHO SHO	7.8	(7.8)	(7.2)	7.6	7.4	7.2	7.2	(7.0)	(8.0)	7.8					15.68	6.78		22.461	
2 QUINTERO_AVAS CIELO (MEX)	002 ANAN DAI	7.2	(7.4)	7.2	(7.2)	(6.8)	7.2	(7.6)	7.2	7.6	7.4					15.4	6.54		21.943	
3 SOSA_PIÑA NORMA ANGELIZA (MEX)	008 CHATANYARA KUSHANKU	(5.8)	(5.8)	6.6	6.4	6.6	6.4	(6.8)	6.4	6.8	(6.6)					14.0	5.76		19.766	
4 SOLIS BELLA LAN (USA)	015 GANKAKU	7.2	(7.4)	7.4	7.4	(7.0)	7.0	7.0	(6.6)	(7.6)	7.2					15.12	6.48		21.6	4
5 BELLORIN_DAVILA ANY VALERIA (VEN)																				
6 CAMPOS_GUZMAN DORIAN GISELIS (PUR)	002 ANAN DAI	7.2	7.4	7.4	7.4	6.8	(6.6)	(6.6)	7.0	(8.0)	(7.8)					14.98	6.54		21.525	
7 CALVO_LEAL ARIELA (CRC)	021 GOJUSHIHO SHO	(5.6)	(5.4)	6.8	7.0	6.4	6.4	6.2	6.2	(7.8)	(7.6)					13.58	5.88		19.467	
8 DE_LA_O_GARCIA XIMENA (MEX)	001 ANAN	(6.8)	(7.0)	7.2	7.0	7.6	7.4	7.4	7.4	(8.2)	(8.0)					15.54	6.54		22.082	

R1 G4/4 (7) Tatami 2 12:25

Competitors	Kata	1T	1A	2T	2A	3T	3A	4T	4A	5T	5A	6T	6A	7T	7A	TEC	ATH	Extra	Total	Rank
1 SALAME_ROZILLIO CECY (MEX)	008 CHATANYARA KUSHANKU	6.6	6.4	(5.6)	(5.8)	6.6	6.6	(7.2)	(7.0)	7.2	6.6					14.28	5.88		20.166	
2 SKINNER LUCY (USA)	020 GOJUSHIHO DAI	(6.8)	6.6	(6.0)	(6.2)	6.4	6.2	6.8	(7.0)	6.4	6.4					13.72	5.76		19.487	
3 LOBO_ARAUZ SAMANTHA (CRC)	020 GOJUSHIHO DAI	7.2	6.6	7.2	(7.4)	(6.4)	(6.4)	7.2	7.4	(7.6)	7.4					15.12	6.42		21.544	
4 CASTRO_MOLINA CAMILA (VEN)	001 ANAN	(8.2)	(8.2)	8.0	8.0	(7.4)	(7.2)	7.4	7.6	7.4	7.2					15.96	6.84		22.8	2
5 GONZALEZ MEZTLI RENATA (MEX)	064 OHAN DAI	(8.0)	(7.8)	7.2	7.0	7.4	7.6	7.8	7.8	(6.8)	(6.8)					15.68	6.72		22.4	3
6 CARDONA_GRAJALES_SARA (COL)	020 GOJUSHIHO DAI	(7.8)	7.8	7.8	(8.0)	7.6	7.6	7.6	7.6	(7.4)	(7.4)					16.1	6.9		23.0	1
7 AGUILAR_ALBIZURES MARIA RENEE (GUA)	030 HEIKU	(7.0)	(7.0)	(6.6)	7.0	6.8	6.6	6.8	6.8	6.8	(6.4)					14.28	6.12		20.4	5

R2-G1

Competitors	Kata	1T	1A	2T	2A	3T	3A	4T	4A	5T	5A	6T	6A	7T	7A	TEC	ATH	Extra	Total	Rank
1 ALVARADO_PORRAS ANA MARIA (CRC)	015 GANKAKU	(7.4)	(7.4)	(7.2)	7.2	7.2	(7.0)	7.2	7.0	7.4	7.4					15.26	6.48		21.747	
2 GALVAN_RODRIGUEZ MICHELLE (MEX)	068 PAPUREN	(7.8)	(7.6)	7.4	7.4	(7.2)	(7.0)	7.4	7.0	7.6	7.6					15.68	6.6		22.285	
3 NAVARRETE GABRIELA (USA)	068 PAPUREN	(8.0)	(8.4)	8.0	7.8	7.6	7.6	(7.4)	7.6	7.4	(7.4)					16.1	6.9		23.0	2
4 OLIGINO DIANA (VEN)	015 GANKAKU	(8.4)	(8.4)	8.0	7.6	(7.2)	(7.2)	7.2	7.2	7.6	7.6					15.96	6.72		22.683	
5 HERRERA_CASTRO ERICKA SUZETHE (MEX)	009 CHIBANA NO KUSHANKU	(8.0)	(7.8)	(7.4)	7.4	7.4	7.4	7.4	(7.2)	7.4	7.4					15.54	6.66		22.2	6
6 CASTRO TREJOS_LIZETH MANUELA (COL)	015 GANKAKU	(7.6)	(7.4)	7.6	7.2	7.4	7.0	(7.0)	(6.8)	7.0	6.8					15.4	6.3		21.7	8
7 CHU JADE LI-YA MISAKI (USA)	068 PAPUREN	7.6	(7.4)	(7.8)	(7.8)	7.6	7.4	(7.4)	7.4	7.4	7.4					15.82	6.66		22.484	
8 BUI MAI-LINH (FRA)	021 GOJUSHIHO SHO	(8.6)	(8.6)	8.2	7.8	(7.6)	(7.6)	7.6	7.6	7.8	7.8					16.52	6.96		23.481	



Karate1 Youth League - Acapulco 2022 - 2022-01-21  
Cadet Kata Female

R2-G2

Competitors	Kata	1T	1A	2T	2A	3T	3A	4T	4A	5T	5A	6T	6A	7T	7A	TEC	ATH	Extra	Total	Rank
1 AGUILAR_CRUZ NICOLE (ECU)	099 UNSU	7.4	7.2	7.4	7.6	(6.8)	(6.6)	(7.8)	(7.8)	7.6	7.8					15.68	6.78		22.46	3
2 SOLIS BELLA_LAN (USA)	001 ANAN	(6.6)	(6.4)	(7.2)	(7.0)	6.6	6.6	7.2	7.0	6.8	6.8					14.42	6.12		20.54	8
3 DE_LA_O_GARCIA XIMENA (MEX)	092 SUPARINPEI	7.4	7.6	(6.8)	6.8	7.0	(6.6)	(8.4)	(8.0)	6.8	6.8					14.84	6.36		21.2	7
4 CASTRO_MOLINA CAMILA (VEN)	002 ANAN DAI	(7.6)	(7.4)	7.8	7.6	8.0	8.0	(8.4)	(8.2)	7.8	8.0					16.52	7.08		23.6	1
5 QUINTERO_AVAS CIELO (MEX)	008 CHATANYARA KUSHANKU	7.0	(7.4)	(7.4)	7.2	(6.8)	(6.6)	7.4	7.4	6.8	7.0					14.84	6.48		21.32	6
6 CARDONA GRAJALES_SARA (COL)	015 GANKAKU	(7.6)	(7.6)	8.0	8.0	7.6	7.8	(8.4)	(8.4)	7.6	7.8					16.24	7.08		23.32	2
7 GONZALEZ MEZTLI_RENATA (MEX)	008 CHATANYARA KUSHANKU	7.2	7.2	7.4	7.2	(6.8)	(6.8)	(7.8)	(7.8)	6.8	6.8					14.98	6.36		21.34	4
8 LOBO_ARAUZ SAMANTHA (CRC)	021 GOJUSHIHO SHO	(6.8)	7.2	7.4	7.4	7.0	(7.0)	(7.8)	(7.6)	6.8	7.0					14.84	6.48		21.32	5

R3-G1

Competitors	Kata	1T	1A	2T	2A	3T	3A	4T	4A	5T	5A	6T	6A	7T	7A	TEC	ATH	Extra	Total	Rank
1 CHU JADE_LI-YA MISAKI (USA)	092 SUPARINPEI	(7.8)	(7.8)	7.8	7.6	(7.4)	(7.4)	7.6	7.4	7.6	7.4					16.1	6.72		22.82	4
2 OLIGINO DIANA (VEN)	092 SUPARINPEI	(8.4)	(8.4)	8.2	8.2	(7.6)	(7.4)	7.6	7.6	7.8	7.6					16.52	7.02		23.54	2
3 NAVARRETE GABRIELA (USA)	008 CHATANYARA KUSHANKU	(8.2)	(8.0)	8.0	7.8	7.8	7.6	(7.6)	(7.4)	7.6	7.6					16.38	6.9		23.28	3
4 BUI MAI-LINH (FRA)	092 SUPARINPEI	(8.2)	(8.6)	8.0	8.0	(7.8)	7.8	7.8	(7.6)	8.0	7.8					16.66	7.08		23.74	1

R3-G2

Competitors	Kata	1T	1A	2T	2A	3T	3A	4T	4A	5T	5A	6T	6A	7T	7A	TEC	ATH	Extra	Total	Rank
1 CASTRO_MOLINA CAMILA (VEN)	068 PAPUREN	7.6	7.8	(8.4)	(8.4)	8.0	8.0	8.4	8.2	(7.2)	(7.6)					16.8	7.2		24.0	1
2 GONZALEZ MEZTLI_RENATA (MEX)	068 PAPUREN	7.6	(7.6)	(7.8)	7.6	(7.6)	(7.4)	7.6	(7.6)	(7.0)	7.4	7.2				15.82	6.66		22.48	4
3 AGUILAR_CRUZ NICOLE (ECU)	020 GOJUSHIHO DAI	7.8	7.8	(8.0)	(8.0)	(7.6)	7.8	7.8	7.8	7.6	(7.4)					16.24	7.02		23.26	3
4 CARDONA GRAJALES_SARA (COL)	021 GOJUSHIHO SHO	(7.6)	(7.6)	(8.6)	(8.6)	8.0	7.8	8.2	8.0	7.8	7.6					16.8	7.02		23.82	2

R4 Bronze Medal Match 1

Competitors	Kata	1T	1A	2T	2A	3T	3A	4T	4A	5T	5A	6T	6A	7T	7A	TEC	ATH	Extra	Total	Rank
1 OLIGINO DIANA (VEN)	020 GOJUSHIHO DAI	(8.4)	(8.4)	8.0	8.2	(7.6)	(7.4)	7.6	7.6	7.8	7.6					16.38	7.02		23.4	1
2 AGUILAR_CRUZ NICOLE (ECU)	041 KANKU SHO	(8.0)	(7.8)	7.6	7.6	(7.4)	(7.2)	7.4	7.6	7.6	7.8					15.82	6.9		22.72	2

R4 Bronze Medal Match 2

Competitors	Kata	1T	1A	2T	2A	3T	3A	4T	4A	5T	5A	6T	6A	7T	7A	TEC	ATH	Extra	Total	Rank
1 NAVARRETE GABRIELA (USA)	092 SUPARINPEI	(8.4)	(8.4)	(8.0)	8.2	8.2	8.4	8.2	8.0	8.0	(7.8)					17.08	7.38		24.46	1
2 CARDONA GRAJALES_SARA (COL)	041 KANKU SHO	(8.6)	(8.4)	8.0	8.0	(7.8)	(7.8)	7.8	7.8	7.8	7.8					16.52	7.08		23.6	2

R4 Gold Medal Match

Competitors	Kata	1T	1A	2T	2A	3T	3A	4T	4A	5T	5A	6T	6A	7T	7A	TEC	ATH	Extra	Total	Rank
1 BUI MAI-LINH (FRA)	078 SANSAI	(8.6)	(8.6)	8.4	8.4	(8.2)	8.4	8.2	8.4	8.2	(8.0)					17.36	7.56		24.92	1
2 CASTRO_MOLINA CAMILA (VEN)	092 SUPARINPEI	(8.4)	(8.2)	(8.0)	(8.0)	8.0	8.0	8.0	8.0	8.0	8.0					16.8	7.2		24.0	2

Results

1	BUI MAI-LINH		FRANCE
2	CASTRO MOLINA CAMILA		VENEZUELA
3	OLIGINO DIANA		VENEZUELA
3	NAVARRETE GABRIELA		UNITED STATES



Karate1 Youth League - Acapulco 2022 - 2022-01-21  
Cadet Kata Male

R1 G1/4 (9) Tatami 1 09:00

Competitors	Kata	1T	1A	2T	2A	3T	3A	4T	4A	5T	5A	6T	6A	7T	7A	TEC	ATH	Extra	Total	Rank
1 GONZALEZ_PAZ CARLOS_ERNESTO (ESA)	001 ANAN	6.8	6.8	(6.4)	(6.4)	6.8	6.6	(7.6)	(7.6)	6.8	7.0					14.28	6.12		20.4	5
2 RUIZ_GARCIA LUIS_CARLOS (MEX)	068 PAPUREN	(6.2)	(6.0)	6.2	6.2	6.2	6.2	(6.8)	(7.0)	6.6	6.4					13.3	5.64		18.94	8
3 GARZA_VIZCAINO JOSE_MARCELO (MEX)	019 GOJUSHIHO	(5.8)	(5.8)	6.2	6.4	6.2	6.4	(7.0)	(6.8)	6.6	6.2					13.3	5.7		19.0	7
4 NACU MATEO (USA)	021 GOJUSHIHO SHO	(7.8)	(7.8)	7.8	7.8	(6.8)	(6.8)	7.6	7.6	7.8	7.8					16.24	6.96		23.2	1
5 ARAMBULA_PADILLA ERYNN_ZAHID (MEX)	083 SEIPAI	(6.2)	6.6	(7.2)	7.0	6.2	(6.2)	7.0	(7.2)	6.6	6.6					13.86	6.06		19.92	6
6 VILLAREAL ERNESTO (PAN)																				
7 MONROY_LOPEZ HUGO_GAEL (MEX)	001 ANAN	6.6	(6.4)	(7.4)	(7.2)	(6.2)	6.4	7.4	7.0	6.8	7.0					14.56	6.12		20.68	4
8 LOPEZ_HERNANDEZ NEFTALI (MEX)	008 CHATANYARA KUSHANKU	7.4	7.4	(7.6)	(7.6)	(6.8)	(6.6)	7.2	7.2	7.2	7.0					15.26	6.48		21.74	3
9 BOJORQUEZ_CERVANTES HECMAR_ARNOLDO (MEX)	002 ANAN DAI	7.6	7.4	(7.8)	(8.0)	(6.8)	(6.8)	7.4	7.6	7.4	7.2					15.68	6.66		22.34	2

R1 G2/4 (8) Tatami 1 09:35

Competitors	Kata	1T	1A	2T	2A	3T	3A	4T	4A	5T	5A	6T	6A	7T	7A	TEC	ATH	Extra	Total	Rank
1 GARCIA_VALADEZ JUAN_PABLO (MEX)	008 CHATANYARA KUSHANKU	(7.8)	(7.6)	7.6	7.6	(7.0)	(7.0)	7.2	7.4	7.4	7.2					15.54	6.66		22.2	4
2 MACIAS_CASTELLANOS JUAN_PABLO (MEX)	064 OHAN DAI	(7.8)	7.8	7.8	(8.0)	(7.4)	(7.2)	7.4	7.6	7.6	7.6					15.96	6.9		22.86	2
3 OLLAGNERO GIOVANNI (ITA)	019 GOJUSHIHO	7.4	(7.6)	7.4	(7.2)	(7.6)	7.4	(7.2)	7.4	7.2	7.4					15.4	6.66		22.06	5
4 ROJAS_SANCHEZ ARATH_SAID (MEX)	012 ENPI	7.2	7.4	(7.8)	(7.8)	7.4	(7.2)	(7.0)	7.4	7.4	7.2					15.4	6.6		22.0	6
5 SANTIAGO_ZAVALA LUIS_EDUARDO (MEX)																				
6 GRUITIA MATTHEW_B (CAN)	047 KURURUNFA	8.0	7.8	(8.2)	(8.2)	(7.6)	(7.4)	7.6	7.6	7.6	7.4					16.24	6.84		23.08	1
7 PADILLA_NAVARRO MARIO_ANDRE (MEX)	008 CHATANYARA KUSHANKU	(7.2)	7.0	(7.4)	(7.2)	7.4	7.2	7.2	(6.8)	7.4	7.0					15.4	6.36		21.76	7
8 CASTILLO_BARRIOS JOSHUA_DANERY (GUA)	078 SANSAL	(8.2)	(8.0)	(7.4)	7.6	7.6	7.6	7.4	(7.4)	7.6	7.6					15.82	6.84		22.66	3

R1 G3/4 (9) Tatami 2 09:00

Competitors	Kata	1T	1A	2T	2A	3T	3A	4T	4A	5T	5A	6T	6A	7T	7A	TEC	ATH	Extra	Total	Rank
1 PINHEIRO PEDRO (USA)	002 ANAN DAI	7.0	7.2	(8.0)	(8.2)	7.0	7.4	7.4	(7.0)	(6.8)	7.2					14.98	6.54		21.52	3
2 SERENO OSCAR (MEX)	008 CHATANYARA KUSHANKU	(5.2)	(5.0)	(6.6)	6.0	6.4	(6.2)	6.2	6.0	5.8	6.0					12.88	5.4		18.28	7
3 BUCAY_MIZRAHI JONATHAN (MEX)	002 ANAN DAI	(5.6)	(5.8)	(7.6)	(7.4)	6.6	6.4	6.6	6.4	6.2	6.4					13.58	5.76		19.34	5
4 OROZCO_GALICIA DANTE_ALEJANDRO (MEX)	068 PAPUREN	6.8	6.8	(7.4)	(7.2)	6.6	(6.6)	7.0	6.8	(6.4)	6.6					14.28	6.06		20.34	4
5 PONCE_SANCHEZ FABBIO_ALESSANDRO (MEX)																				
6 MIZRAHI_KALACH SONY (MEX)	008 CHATANYARA KUSHANKU	(5.0)	(5.0)	(6.8)	(6.6)	6.0	6.2	6.0	5.8	5.8	6.0					12.46	5.4		17.86	8
7 DIAZ_DE_LEON MAXIMO (MEX)	001 ANAN	(7.0)	(7.2)	(8.2)	(8.0)	7.2	7.2	7.6	7.4	7.6	7.8					15.68	6.72		22.4	2
8 MORENO_FLORES GUILLERMO_ZABDIEL (MEX)	036 JION	(5.2)	(5.4)	(6.6)	(6.6)	6.4	6.4	6.0	6.0	6.0	6.2					12.88	5.58		18.46	6
9 NARVAEZ MARCO (ECU)	021 GOJUSHIHO SHO	7.4	7.4	(8.6)	(8.4)	7.4	(7.2)	(7.0)	7.2	8.2	8.4					16.1	6.9		23.0	1

R1 G4/4 (8) Tatami 2 09:35

Competitors	Kata	1T	1A	2T	2A	3T	3A	4T	4A	5T	5A	6T	6A	7T	7A	TEC	ATH	Extra	Total	Rank
1 ZAVALA_MERCADO JOSE_JUAN (MEX)	015 GANKAKU	(7.0)	(6.8)	6.4	6.4	6.6	6.2	(5.6)	(5.8)	6.2	6.0					13.44	5.58		19.02	7
2 POLLEY CHASE (USA)	064 OHAN DAI	(8.4)	(8.4)	7.6	(7.4)	7.6	7.4	(7.2)	7.4	7.4	7.6					15.82	6.72		22.54	1
3 LOPEZ ZACK (USA)																				
4 MONTALVETTI PATRICIO (ARG)	008 CHATANYARA KUSHANKU	(8.2)	(8.4)	(7.2)	7.2	7.2	7.4	7.2	(7.0)	7.2	7.4					15.12	6.6		21.72	4
5 ATTARD ZACHARY (ENG)	001 ANAN	(7.8)	(7.6)	(6.6)	(6.8)	6.8	7.0	6.6	6.8	7.0	7.4					14.28	6.36		20.64	5
6 NGUYEN ALEX (USA)	009 CHIBANA NO KUSHANKU	(8.2)	(8.2)	(7.0)	7.4	7.4	7.6	7.0	7.4	7.0	(7.2)					14.98	6.72		21.7	5
7 NAKAJIMA-WU AIDAN (USA)	068 PAPUREN	(8.4)	(8.2)	7.6	7.4	7.4	(6.8)	(6.8)	7.0	7.2	7.6					15.54	6.6		22.14	2
8 GRANADOS_HERRERA ANGEL_EMIO (ESA)	008 CHATANYARA KUSHANKU	(8.2)	(8.2)	7.2	7.2	(6.8)	(6.6)	7.2	7.2	7.6	7.6					15.4	6.6		22.0	3

R2-G1

Competitors	Kata	1T	1A	2T	2A	3T	3A	4T	4A	5T	5A	6T	6A	7T	7A	TEC	ATH	Extra	Total	Rank
1 MONROY_LOPEZ HUGO_GAEL (MEX)	092 SUPARINPEI	6.8	6.8	(6.4)	(6.2)	6.8	6.8	(7.2)	(7.0)	7.2	7.0					14.56	6.18		20.74	8
2 CASTILLO_BARRIOS JOSHUA_DANERY (GUA)	020 GOJUSHIHO DAI	(7.8)	(7.8)	7.6	7.6	(6.8)	(6.6)	7.2	7.2	7.6	7.6					15.68	6.72		22.4	4
3 GRUITIA MATTHEW_B (CAN)	068 PAPUREN	(8.2)	8.0	8.2	(8.2)	(7.4)	(7.4)	7.6	7.4	7.8	7.6					16.52	6.9		23.42	1
4 NACU MATEO (USA)	041 KANKU SHO	(8.0)	7.8	8.0	(8.0)	(7.4)	7.6	7.6	7.6	7.6	(7.4)					16.24	6.9		23.14	2
5 LOPEZ_HERNANDEZ NEFTALI (MEX)	002 ANAN DAI	7.0	7.2	7.4	(7.4)	(6.8)	(6.6)	7.2	7.2	(7.6)	7.4					15.12	6.54		21.66	7
6 BOJORQUEZ_CERVANTES HECMAR_ARNOLDO (MEX)	042 KANSHU	7.4	7.4	7.4	7.2	(7.0)	(6.8)	7.4	7.2	(7.8)	(7.6)					15.54	6.54		22.08	5
7 GARCIA_VALADEZ JUAN_PABLO (MEX)	002 ANAN DAI	7.4	7.2	(7.6)	(7.6)	(7.2)	(7.0)	7.4	7.0	7.4	7.6					15.54	6.54		22.08	6



## Karate1 Youth League - Acapulco 2022 - 2022-01-21 Cadet Kata Male

8	MACIAS_CASTELLANOS JUAN_PABLO (MEX)	002 ANAN DAI	7.6	7.6	(8.0)	(8.0)	(7.0)	(7.0)	7.4	7.6	8.0	7.8							16.1	6.9		23.0	3
---	-------------------------------------	--------------	-----	-----	-------	-------	-------	-------	-----	-----	-----	-----	--	--	--	--	--	--	------	-----	--	------	---

### R2-G2

Competitors	Kata	1T	1A	2T	2A	3T	3A	4T	4A	5T	5A	6T	6A	7T	7A	TEC	ATH	Extra	Total	Rank	
1	GRANADOS_HERRERA ANGEL_EMIIO (ESA)	002 ANAN DAI	(7.2)	(7.0)	7.2	7.4	7.6	7.8	7.4	7.2	(8.2)	(8.2)					15.54	6.72		22.26	4
2	NARVAEZ MARCO (ECU)	020 GOJUSHIHO DAI	7.6	7.4	(6.8)	(6.6)	(8.4)	(8.4)	7.4	7.6	8.4	8.2					16.38	6.96		23.34	2
3	DIAZ_DE_LEON MAXIMO (MEX)	030 HEIKU	7.4	(7.6)	(6.6)	(6.4)	6.8	7.0	7.0	7.2	(7.6)	7.4					14.84	6.48		21.32	7
4	PINHEIRO PEDRO (USA)	047 KURURUNFA	(7.6)	(7.6)	(8.4)	(8.4)	8.0	8.2	7.8	7.6	8.0	8.0					16.66	7.14		23.8	1
5	MONTALVETTI PATRICIO (ARG)	045 KOUSOUKUN DAI	7.2	7.2	7.4	(7.0)	7.0	7.2	(6.8)	7.2	(7.8)	(7.8)					15.12	6.48		21.6	6
6	POLLEY CHASE (USA)	092 SUPARINPEI	7.8	7.4	7.4	7.4	8.0	(8.2)	(7.2)	(7.2)	(8.2)	8.0					16.24	6.84		23.08	3
7	NAKAJIMA-WU AIDAN (USA)	092 SUPARINPEI	7.6	7.4	(7.2)	7.2	7.2	7.2	7.4	(7.0)	(8.2)	(7.6)					15.54	6.54		22.08	5
8	OROZCO GALICIA DANTE_ALEJANDRO (MEX)	009 CHIBANA NO KUSHANKU	7.0	7.2	6.6	6.8	6.8	7.0	(6.4)	(6.6)	(7.6)	(7.8)					14.28	6.3		20.58	8

### R3-G1

Competitors	Kata	1T	1A	2T	2A	3T	3A	4T	4A	5T	5A	6T	6A	7T	7A	TEC	ATH	Extra	Total	Rank	
1	CASTILLO_BARRIOS JOSHUA_DANERY (GUA)	099 UNSU	(7.6)	(7.8)	7.6	7.8	(7.4)	(7.4)	7.4	7.6	7.4						15.82	6.84		22.66	4
2	MACIAS_CASTELLANOS JUAN_PABLO (MEX)	068 PAPUREN	(7.8)	(8.0)	7.6	7.6	(7.2)	(7.0)	7.4	7.4	7.8	7.8					15.96	6.84		22.8	3
3	GRUITIA MATTHEW_B (CAN)	002 ANAN DAI	(8.2)	8.2	8.2	(8.4)	(7.4)	(7.4)	7.6	7.6	7.6	7.8					16.38	7.08		23.46	1
4	NACU MATEO (USA)	099 UNSU	8.0	8.0	(8.2)	(8.2)	(7.2)	(7.4)	7.4	7.6	7.6	7.6					16.1	6.96		23.06	2

### R3-G2

Competitors	Kata	1T	1A	2T	2A	3T	3A	4T	4A	5T	5A	6T	6A	7T	7A	TEC	ATH	Extra	Total	Rank	
1	PINHEIRO PEDRO (USA)	092 SUPARINPEI	8.0	(8.2)	(7.8)	(7.6)	(8.2)	8.0	8.0	7.8	8.0	8.2					16.8	7.2		24.0	1
2	POLLEY CHASE (USA)	048 KUSANKU	7.6	(8.0)	(7.4)	(7.4)	(8.0)	8.0	7.6	7.8	7.6	7.6					15.96	7.02		22.98	3
3	NARVAEZ MARCO (ECU)	099 UNSU	(8.4)	8.4	(7.4)	7.6	8.4	(8.6)	7.8	7.6	7.8	(7.4)					16.8	7.08		23.88	2
4	GRANADOS_HERRERA ANGEL_EMIIO (ESA)	001 ANAN	7.8	7.8	(7.4)	(7.4)	(8.2)	(8.4)	7.4	7.4	7.6	7.8					15.96	6.9		22.86	4

### R4 Bronze Medal Match 1

Competitors	Kata	1T	1A	2T	2A	3T	3A	4T	4A	5T	5A	6T	6A	7T	7A	TEC	ATH	Extra	Total	Rank	
1	NACU MATEO (USA)	020 GOJUSHIHO DAI	8.0	8.0	(8.4)	(8.4)	(7.4)	(7.4)	7.6	7.4	7.8	7.6					16.38	6.9		23.28	1
2	POLLEY CHASE (USA)	002 ANAN DAI	7.8	8.0	(8.6)	(8.6)	(7.4)	(7.2)	7.6	7.6	7.6	7.6					16.1	6.96		23.06	2

### R4 Bronze Medal Match 2

Competitors	Kata	1T	1A	2T	2A	3T	3A	4T	4A	5T	5A	6T	6A	7T	7A	TEC	ATH	Extra	Total	Rank	
1	MACIAS_CASTELLANOS JUAN_PABLO (MEX)	092 SUPARINPEI	(8.4)	(8.4)	8.2	8.0	(7.4)	(7.6)	7.8	7.6	7.6	7.8					16.52	7.02		23.54	2
2	NARVAEZ MARCO (ECU)	015 GANKAKU	(8.6)	(8.8)	8.6	8.4	8.2	8.4	8.2	8.4	(8.0)	(7.8)					17.5	7.56		25.06	1

### R4 Gold Medal Match

Competitors	Kata	1T	1A	2T	2A	3T	3A	4T	4A	5T	5A	6T	6A	7T	7A	TEC	ATH	Extra	Total	Rank	
1	GRUITIA MATTHEW_B (CAN)	064 OHAN DAI	8.2	(8.6)	7.8	(7.6)	(8.4)	8.4	(7.6)	7.8	8.0	7.8					16.8	7.2		24.0	1
2	PINHEIRO PEDRO (USA)	009 CHIBANA NO KUSHANKU	8.2	(8.4)	8.0	(7.6)	(8.4)	8.0	(7.4)	7.6	7.8	7.6					16.8	6.96		23.76	2

### Results

1	GRUITIA MATTHEW B		CANADA
2	PINHEIRO PEDRO		UNITED STATES
3	NACU MATEO		UNITED STATES
3	NARVAEZ MARCO		ECUADOR



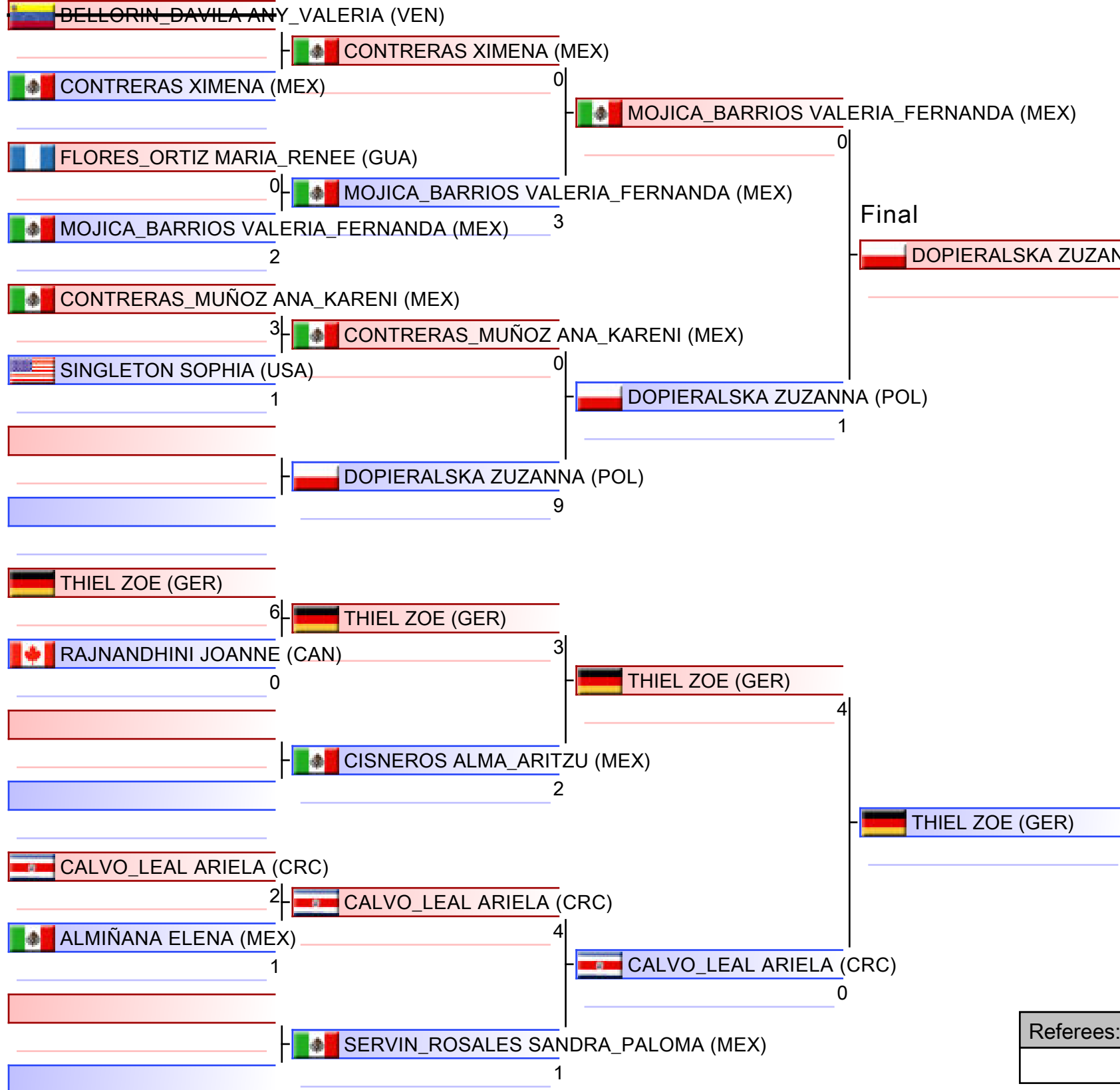

1. THIEL ZOE (GER)
2. DOPIERALSKA ZUZANNA (POL)
3. MOJICA_BARRIOS VALERIA_FERNANDA (MEX)
3. CISNEROS ALMA_ARITZU (MEX)
5. CONTRERAS_XUÑOZ ANA_KARENI (MEX)
5. CALVO_LEAL ARIELA (CRC)
7. RAJNANDHINI JOANNE (CAN)

Referees:			

# Cadet Kumite Female -47 kg

Karate1 Youth League - Acapulco 2022

Tatami  
3 11:20

Pool  
1

(c)sportdata GmbH & Co KG 2000-2022(2022-01-23 12:44) -WKF Approved- v 9.8.8 build 3 (2021-11-04) License: Online\_Event\_ID-560\_Karate1YouthLeagueAcapulco2022 (expire 2022-02-06)

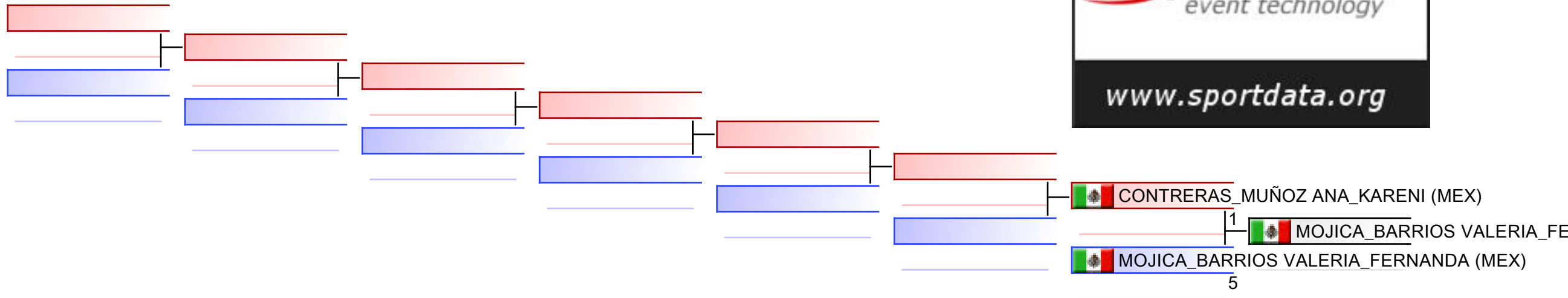

## REPECHAGE: (1)

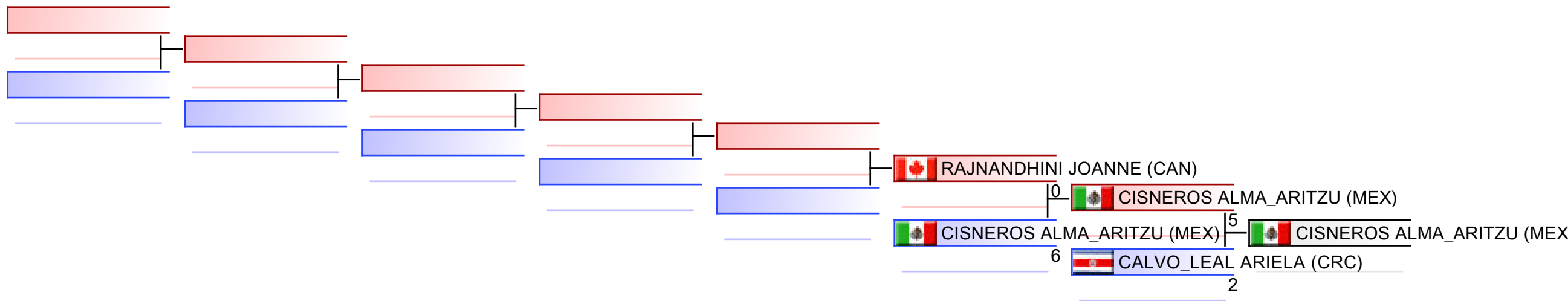

Referees:							
-----------	--	--	--	--	--	--	--

# Cadet Kumite Female -54 kg

Karate1 Youth League - Acapulco 2022, Acapulco, MEX

Tatami  
1 14:15

Pool  
1/1

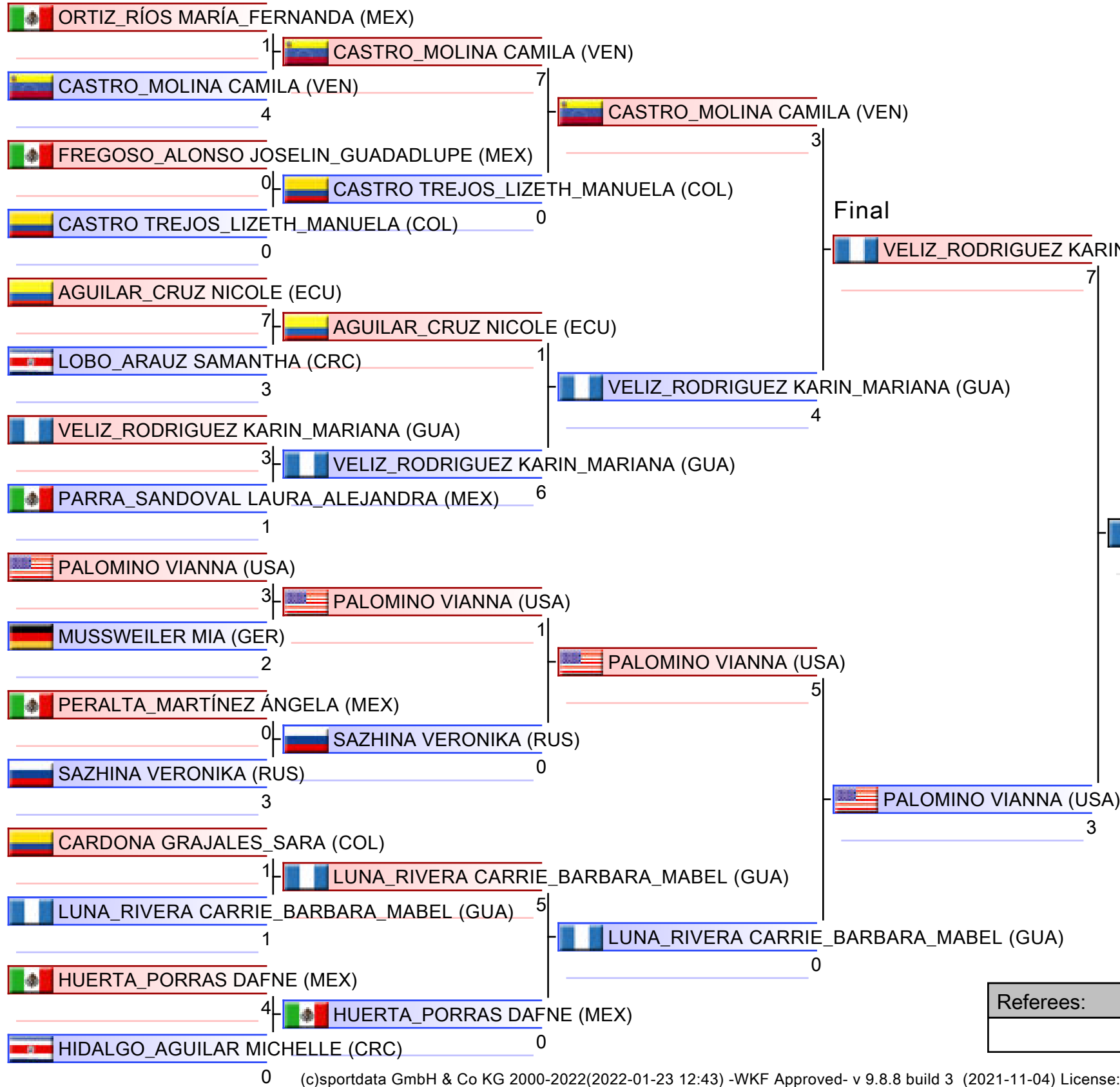

- |   |
|---|
| 1. VELIZ_RODRIGUEZ KARIN_MARIANA (GUA)    |
| 2. PALOMINO VIANNA (USA)                  |
| 3. CASTRO_MOLINA CAMILA (VEN)             |
| 3. MUSSWEILER MIA (GER)                   |
| 5. PARRA_SANDOVAL LAURA_ALEJANDRA (MEX)   |
| 5. LUNA_RIVERA CARRIE_BARBARA_MABEL (GUA) |
| 7. AGUILAR_CRUZ NICOLE (ECU)              |
| 7. SAZHINA VERONIKA (RUS)                 |

Referees:			

# Cadet Kumite Female -54 kg

Karate1 Youth League - Acapulco 2022

Tatami  
1 15:10

Pool  
1

(c)sportdata GmbH & Co KG 2000-2022(2022-01-23 12:44) -WKF Approved- v 9.8.8 build 3 (2021-11-04) License: Online\_Event\_ID-560\_Karate1YouthLeagueAcapulco2022 (expire 2022-02-06)

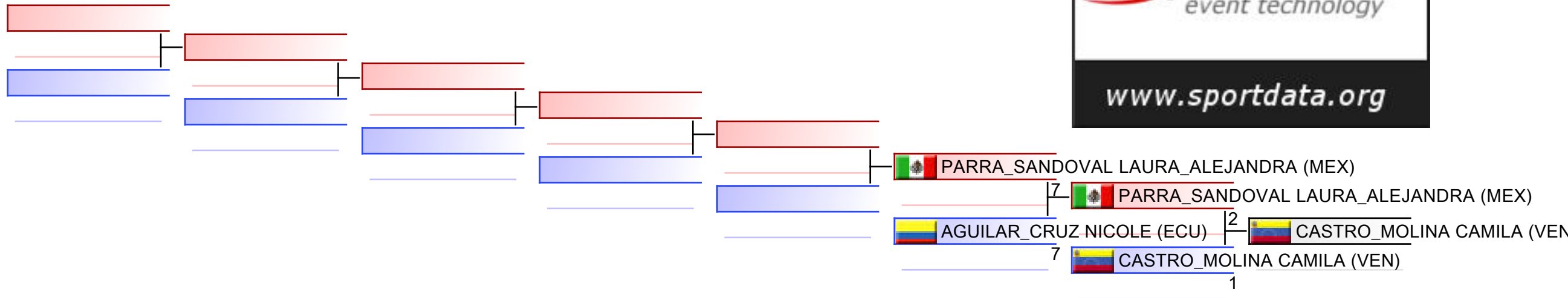

## REPECHAGE: (1)

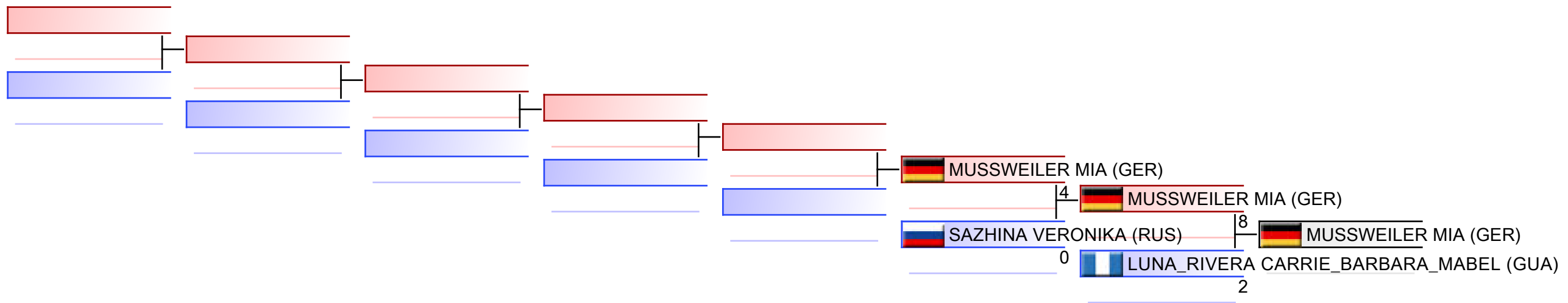

Referees:							
-----------	--	--	--	--	--	--	--

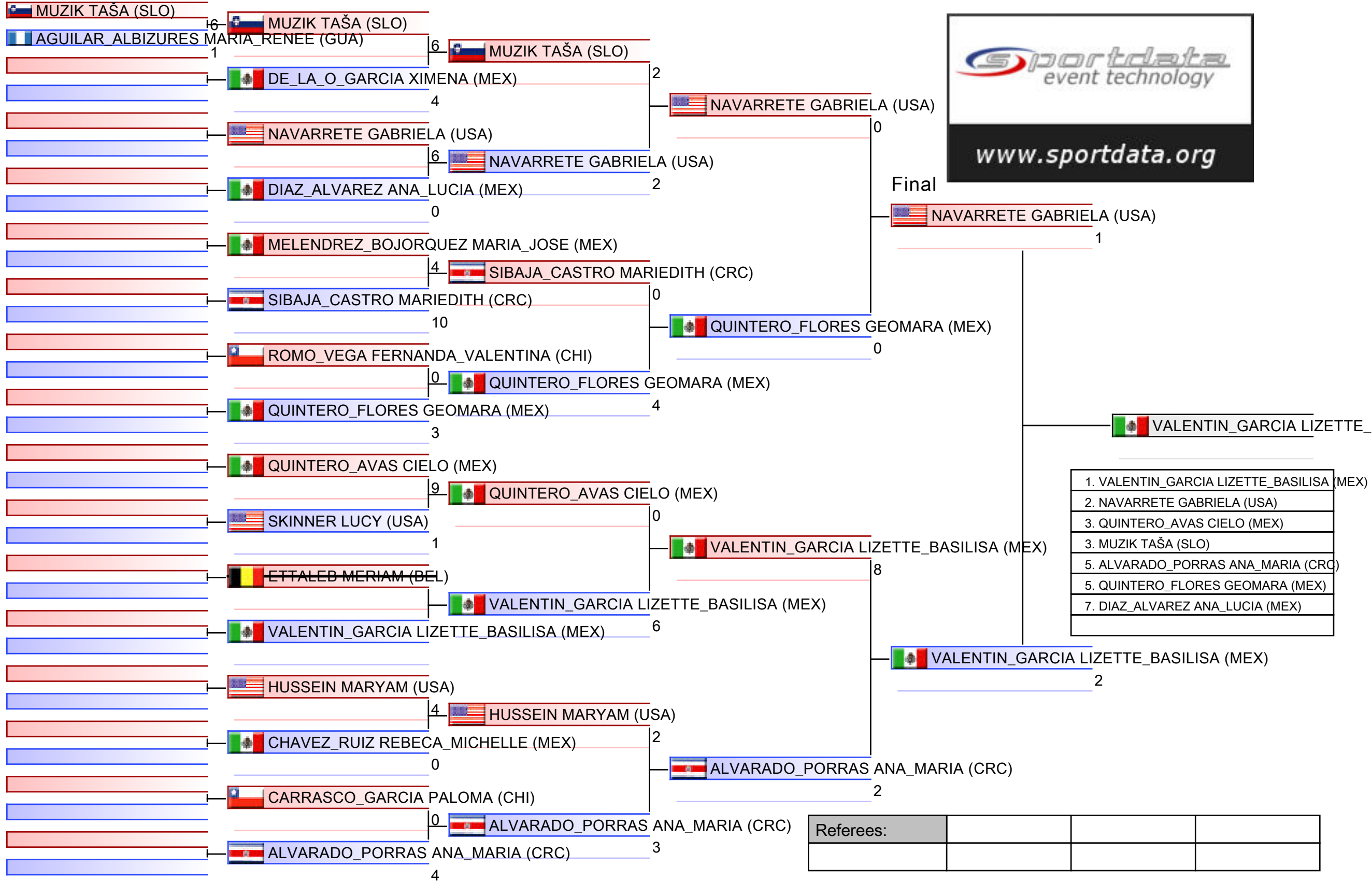

# Cadet Kumite Female 54+ kg

Karate1 Youth League - Acapulco 2022

Tatami  
3 10:00

Pool  
1

(c)sportdata GmbH & Co KG 2000-2022(2022-01-23 12:44) -WKF Approved- v 9.8.8 build 3 (2021-11-04) License: Online\_Event\_ID-560\_Karate1YouthLeagueAcapulco2022 (expire 2022-02-06)

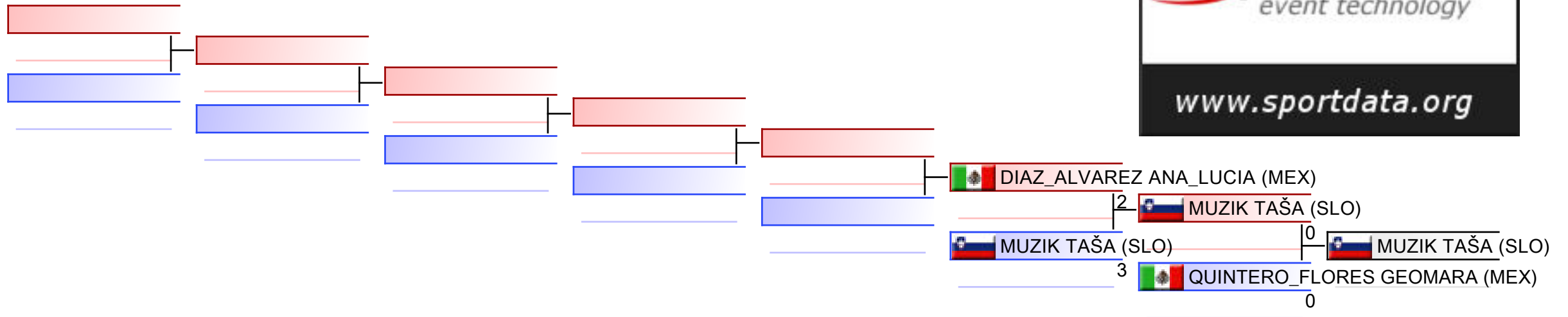

## REPECHAGE: (1)

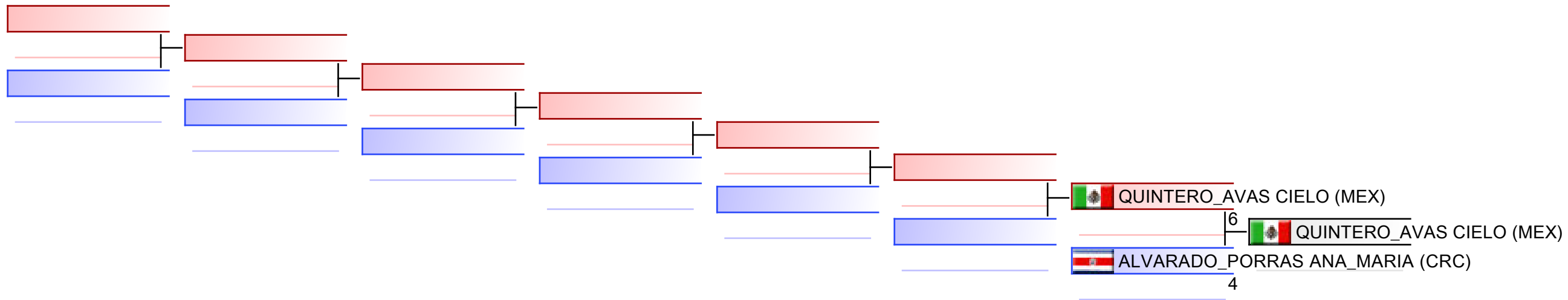

Referees:							
-----------	--	--	--	--	--	--	--

# Cadet Kumite Male -52 kg

Karate1 Youth League - Acapulco 2022, Acapulco, MEX

Tatami  
3 11:50

Pool  
1/2

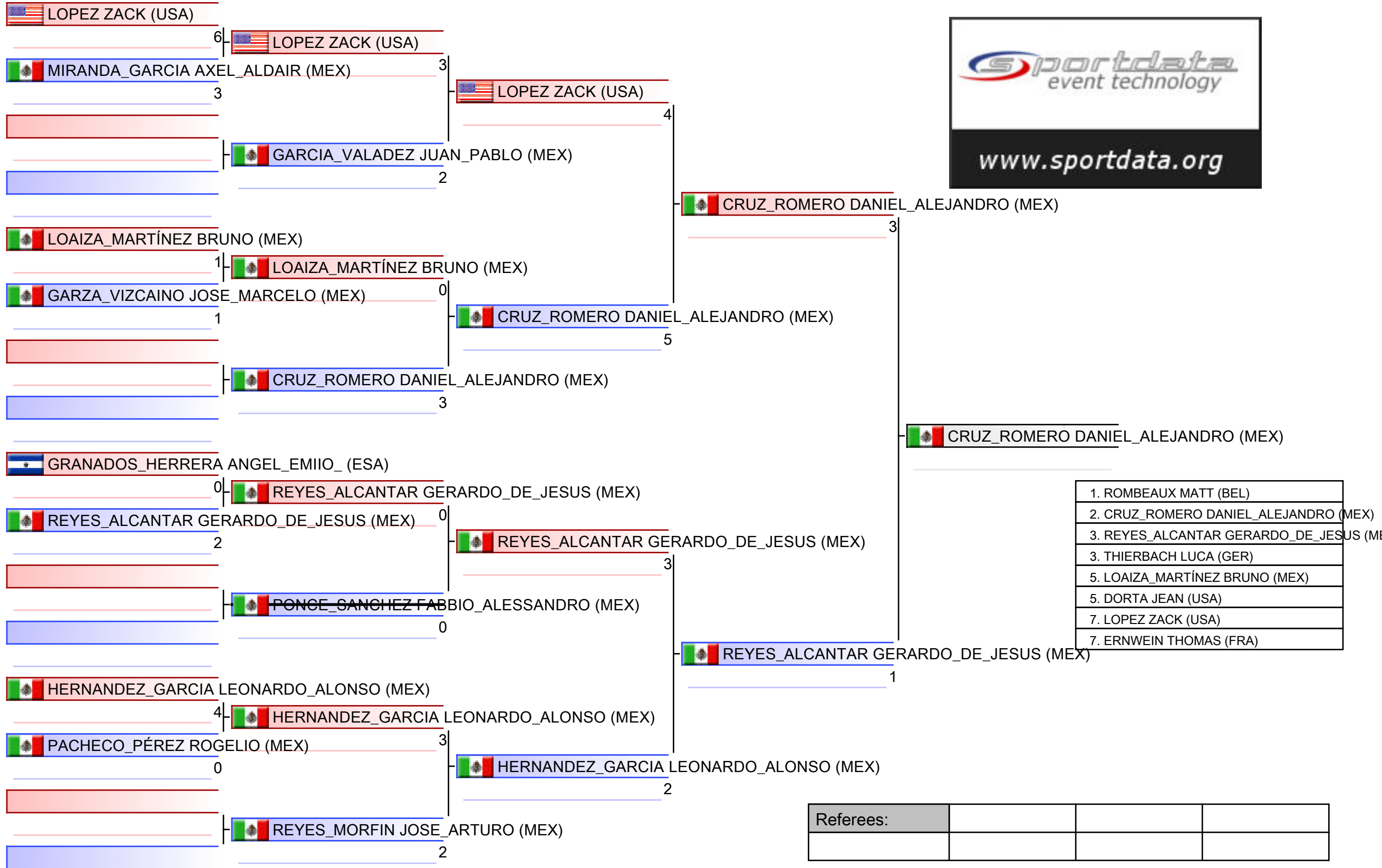





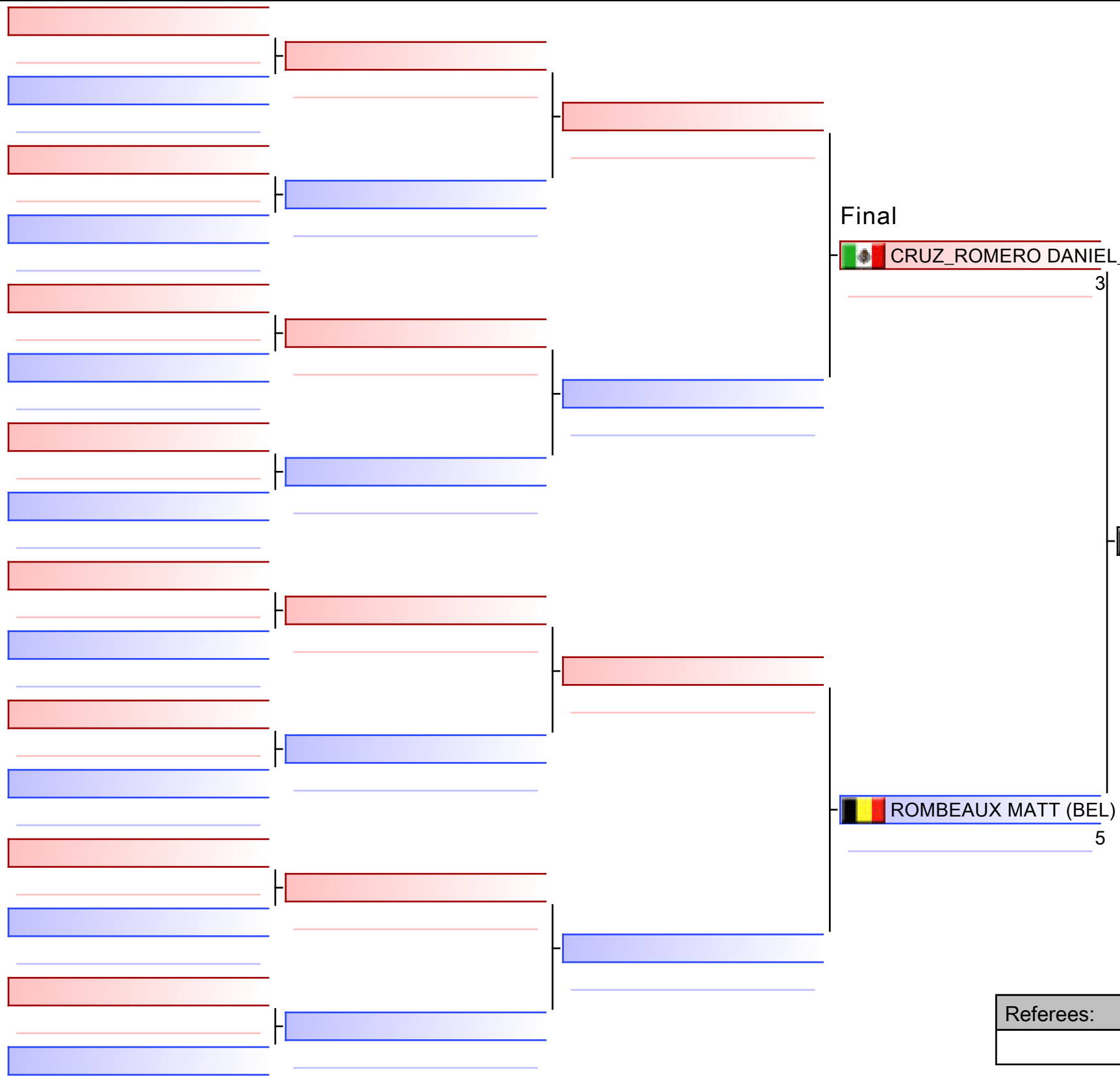

Final

CRUZ\_ROMERO DANIEL\_ALEJANDRO (MEX)

3

ROMBEAUX MATT (BEL)

5

1. ROMBEAUX MATT (BEL)
2. CRUZ_ROMERO DANIEL_ALEJANDRO (MEX)
3. REYES_ALCANTAR GERARDO_DE_JESUS (MEX)
3. THIERBACH LUCA (GER)
5. LOAIZA_MARTÍNEZ BRUNO (MEX)
5. DORTA JEAN (USA)
7. LOPEZ ZACK (USA)
7. ERNWEIN THOMAS (FRA)

Referees:			

# Cadet Kumite Male -52 kg

Karate1 Youth League - Acapulco 2022

Tatami  
3 13:20

Pool  
1,2

(c)sportdata GmbH & Co KG 2000-2022(2022-01-23 12:44) -WKF Approved- v 9.8.8 build 3 (2021-11-04) License: Online\_Event\_ID-560\_Karate1YouthLeagueAcapulco2022 (expire 2022-02-06)

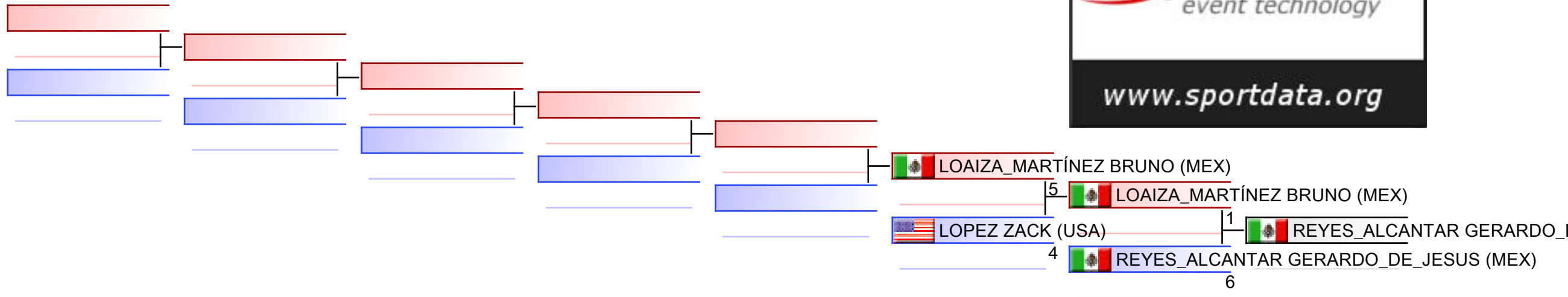

## REPECHAGE: (1,2)

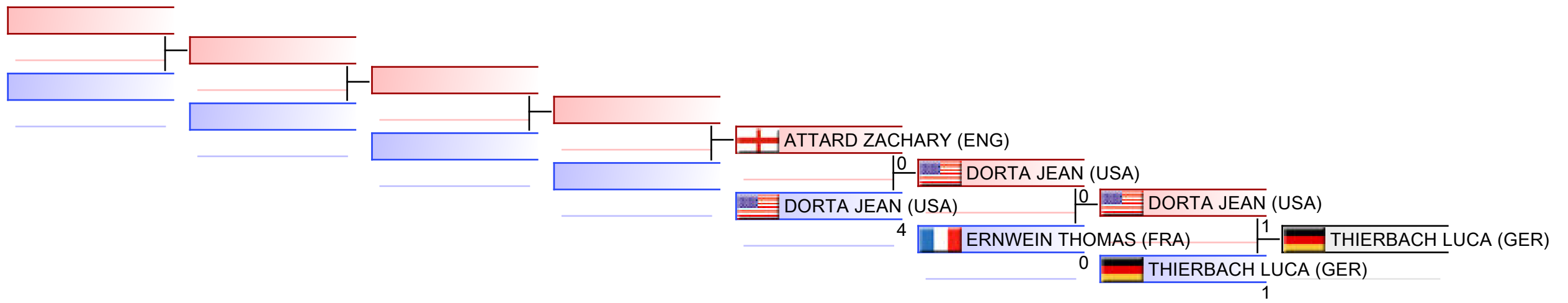

Referees:							
-----------	--	--	--	--	--	--	--

# Cadet Kumite Male -57 kg

Karate1 Youth League - Acapulco 2022, Acapulco, MEX

Tatami  
3 14:15

Pool  
1/1

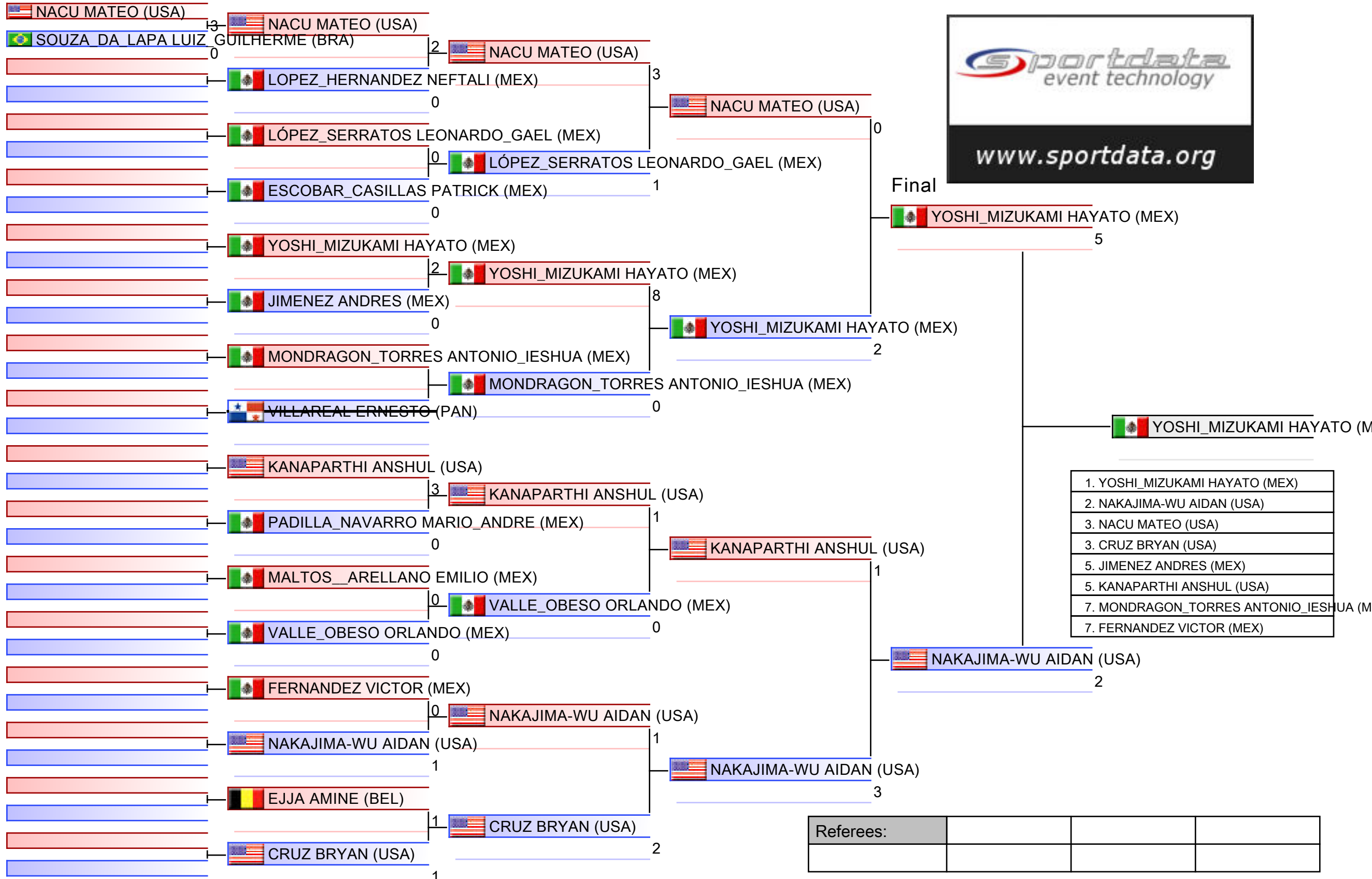

# Cadet Kumite Male -57 kg

Karate1 Youth League - Acapulco 2022

Tatami  
3 15:15

Pool  
1

(c)sportdata GmbH & Co KG 2000-2022(2022-01-23 12:44) -WKF Approved- v 9.8.8 build 3 (2021-11-04) License: Online\_Event\_ID-560\_Karate1YouthLeagueAcapulco2022 (expire 2022-02-06)

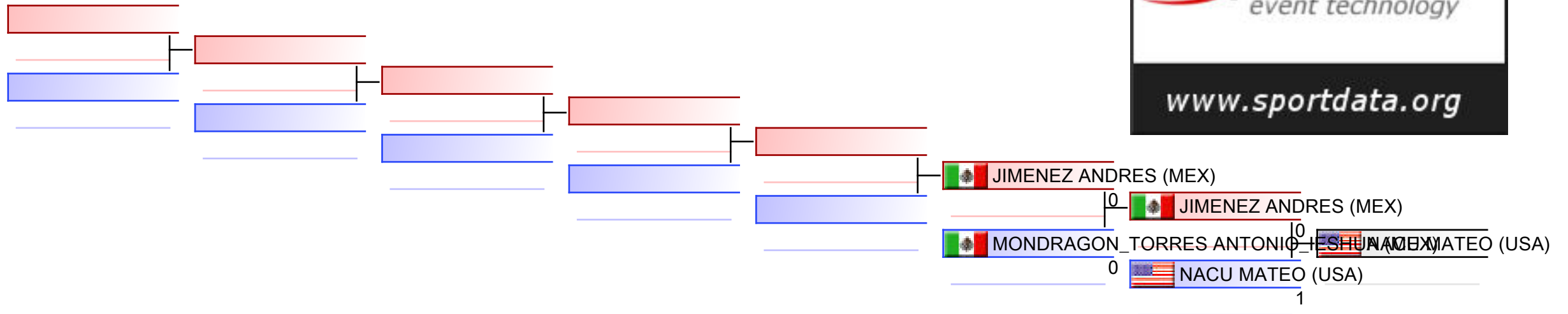

## REPECHAGE: (1)

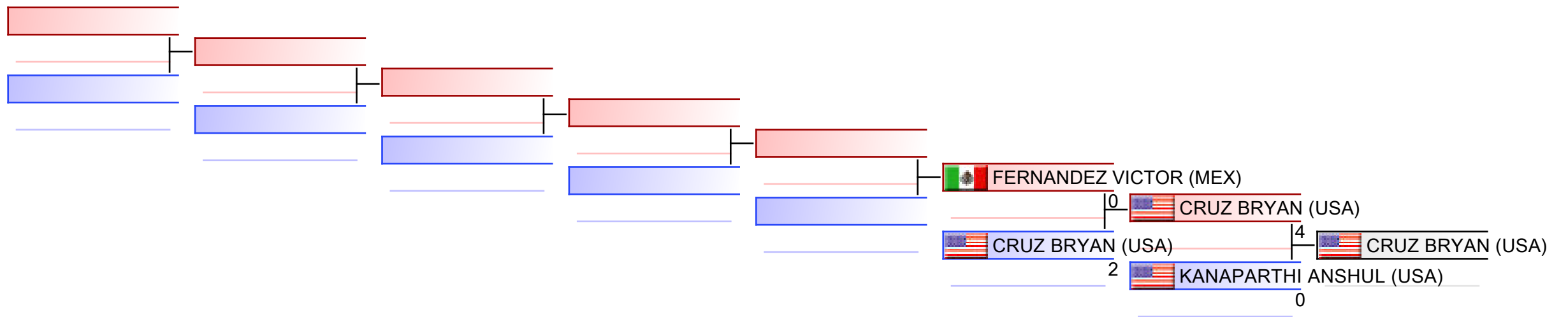

Referees:							
-----------	--	--	--	--	--	--	--

# Cadet Kumite Male -63 kg

Karate1 Youth League - Acapulco 2022, Acapulco, MEX

Tatami  
2 15:20

Pool  
1/1

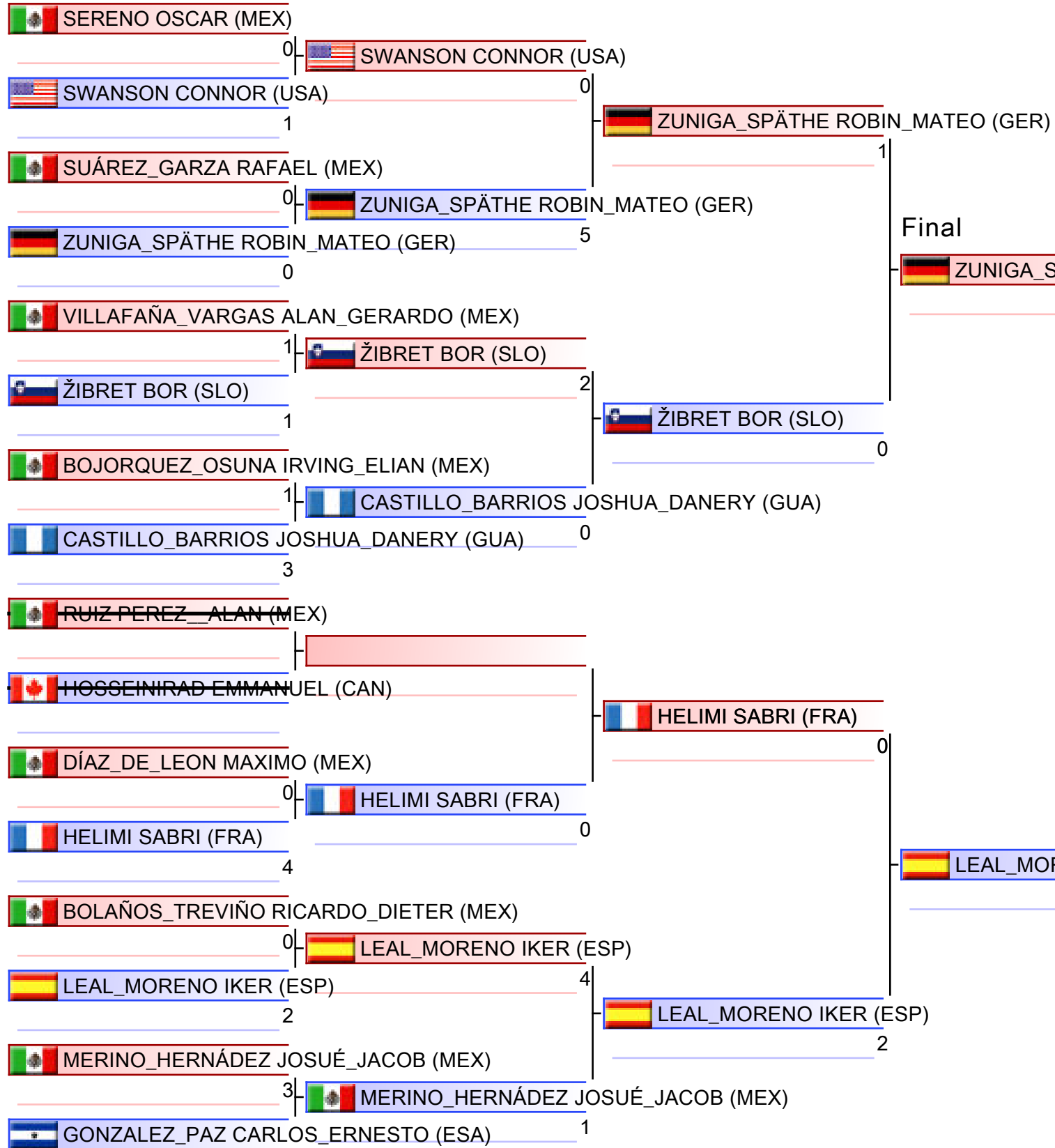

1. LEAL_MORENO IKER (ESP)
2. ZUNIGA_SPÄTHE ROBIN_MATEO (GER)
3. ŽIBRET BOR (SLO)
3. HELIMI SABRI (FRA)
5. SWANSON CONNOR (USA)
5. BOLAÑOS_TREVIÑO RICARDO_DIETER (MEX)
7. SUÁREZ_GARZA RAFAEL (MEX)
7. MERINO_HERNÁNDEZ JOSUÉ_JACOB (MEX)

Referees:			

# Cadet Kumite Male -63 kg

Karate1 Youth League - Acapulco 2022

Tatami  
2 16:15

Pool  
1

(c)sportdata GmbH & Co KG 2000-2022(2022-01-23 12:44) -WKF Approved- v 9.8.8 build 3 (2021-11-04) License: Online\_Event\_ID-560\_Karate1YouthLeagueAcapulco2022 (expire 2022-02-06)

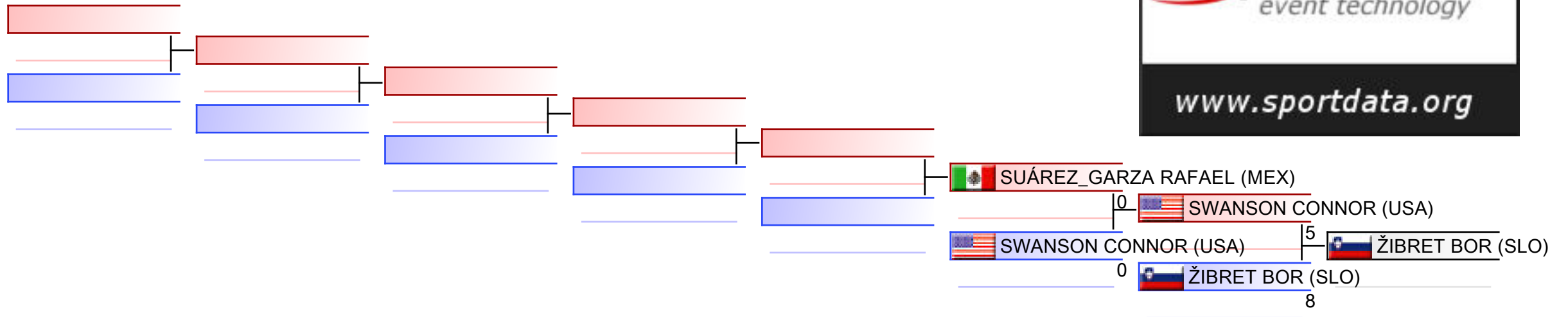

## REPECHAGE: (1)

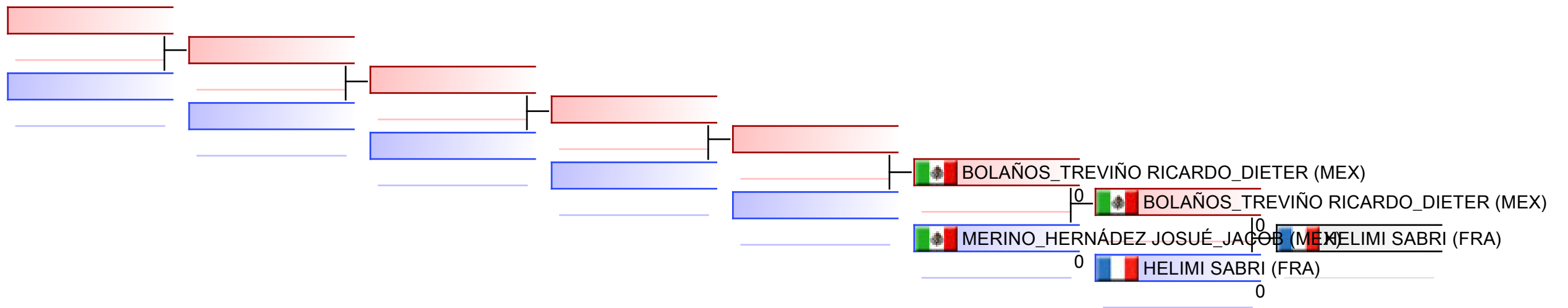

Referees:							
-----------	--	--	--	--	--	--	--

# Cadet Kumite Male -70 kg

Karate1 Youth League - Acapulco 2022, Acapulco, MEX

Tatami  
2 14:15

Pool  
1/1

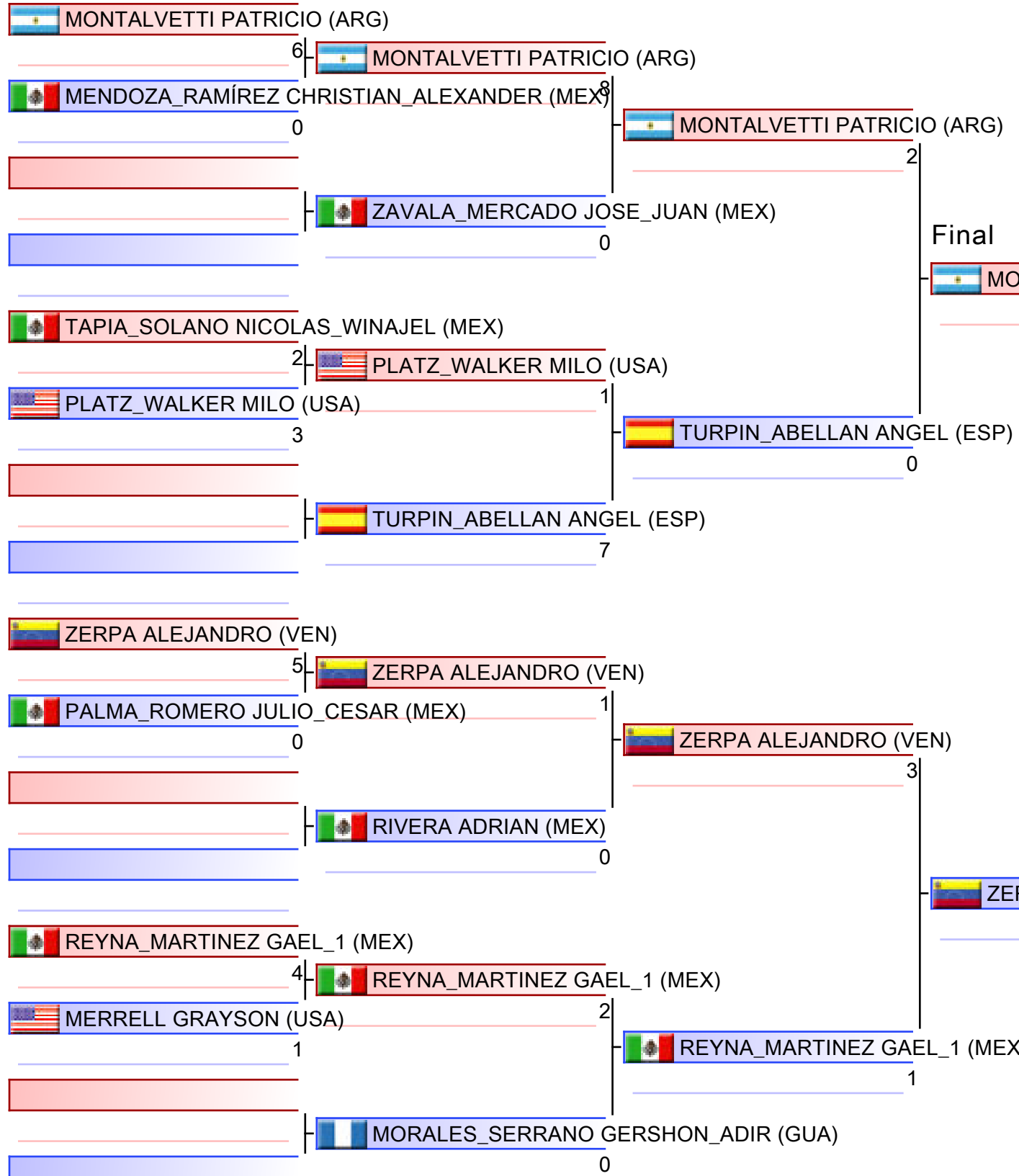

- |  |
|--|
| 1. ZERPA ALEJANDRO (VEN)                     |
| 2. MONTALVETTI PATRICIO (ARG)                |
| 3. TURPIN_ABELLAN ANGEL (ESP)                |
| 3. REYNA_MARTINEZ GAEL_1 (MEX)               |
| 5. MENDOZA_RAMÍREZ CHRISTIAN_ALEXANDER (MEX) |
| 5. RIVERA ADRIAN (MEX)                       |
| 7. ZAVALA_MERCADO JOSE_JUAN (MEX)            |
| 7. PALMA_ROMERO JULIO_CESAR (MEX)            |

Referees:			

# Cadet Kumite Male -70 kg

Karate1 Youth League - Acapulco 2022

Tatami  
2 14:55

Pool  
1

(c)sportdata GmbH & Co KG 2000-2022(2022-01-23 12:44) -WKF Approved- v 9.8.8 build 3 (2021-11-04) License: Online\_Event\_ID-560\_Karate1YouthLeagueAcapulco2022 (expire 2022-02-06)

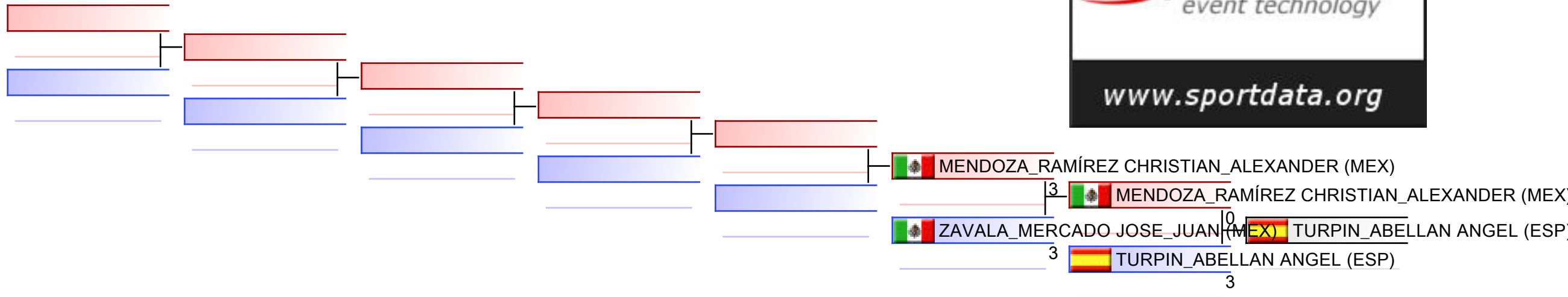

## REPECHAGE: (1)

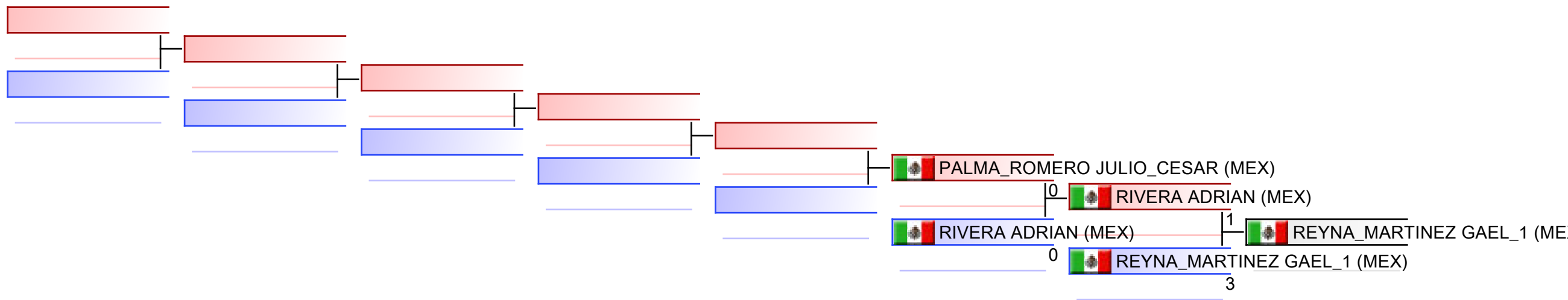

Referees:							
-----------	--	--	--	--	--	--	--



# Cadet Kumite Male 70+ kg

Karate1 Youth League - Acapulco 2022, Acapulco, MEX

Tatami  
1 15:35

Pool  
1/1

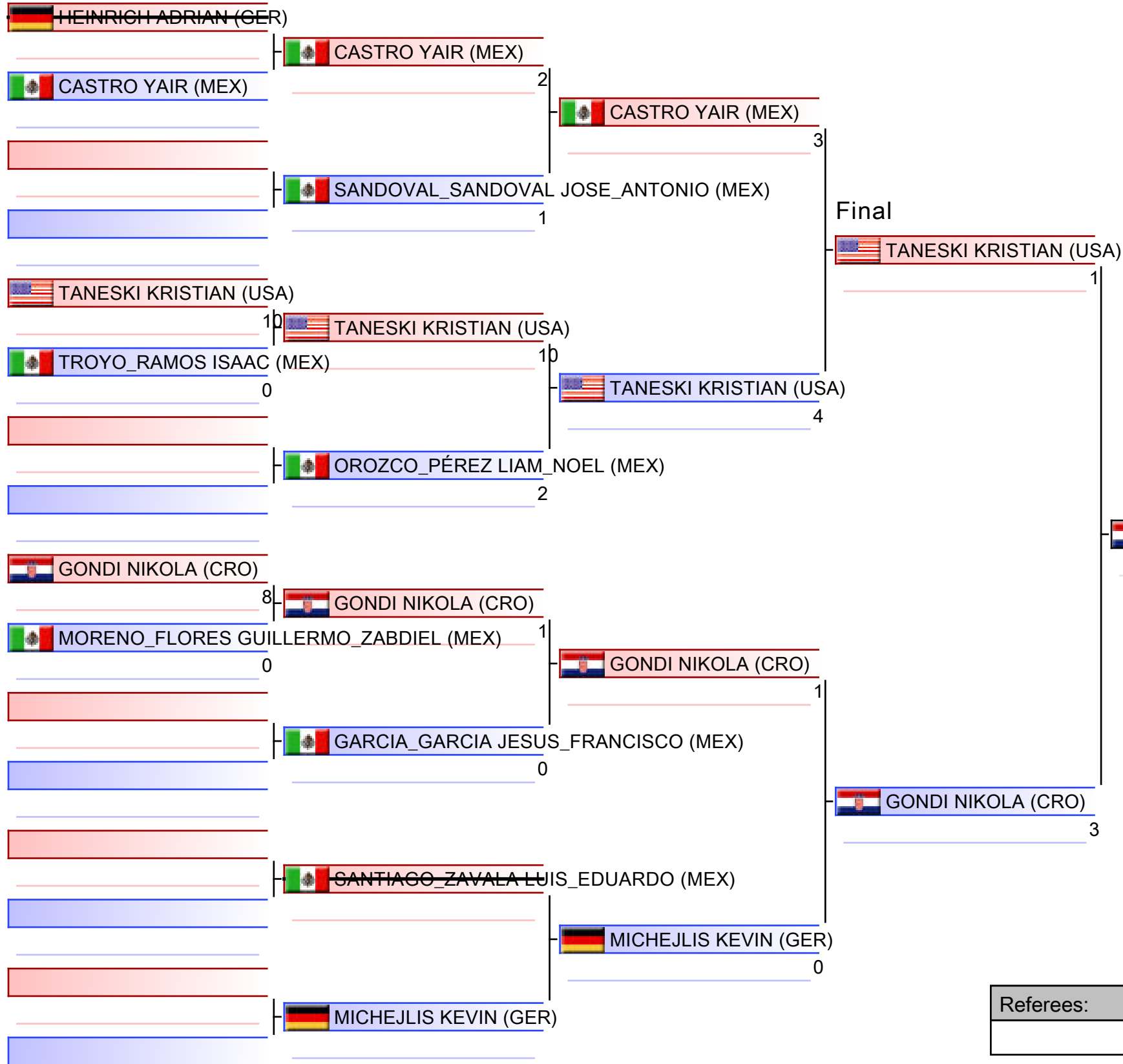

- |  |
|--|
| 1. GONDI NIKOLA (CRO)                    |
| 2. TANESKI KRISTIAN (USA)                |
| 3. OROZCO PÉREZ LIAM NOEL (MEX)          |
| 3. GARCIA GARCIA JESUS FRANCISCO (MEX)   |
| 5. CASTRO YAIR (MEX)                     |
| 5. MICHEJLIS KEVIN (GER)                 |
| 7. TROYO RAMOS ISAAC (MEX)               |
| 7. MORENO FLORES GUILLERMO ZABDIEL (MEX) |

Referees:			

# Cadet Kumite Male 70+ kg

Karate1 Youth League - Acapulco 2022

Tatami  
1 16:10

Pool  
1

(c)sportdata GmbH & Co KG 2000-2022(2022-01-23 12:44) -WKF Approved- v 9.8.8 build 3 (2021-11-04) License: Online\_Event\_ID-560\_Karate1YouthLeagueAcapulco2022 (expire 2022-02-06)

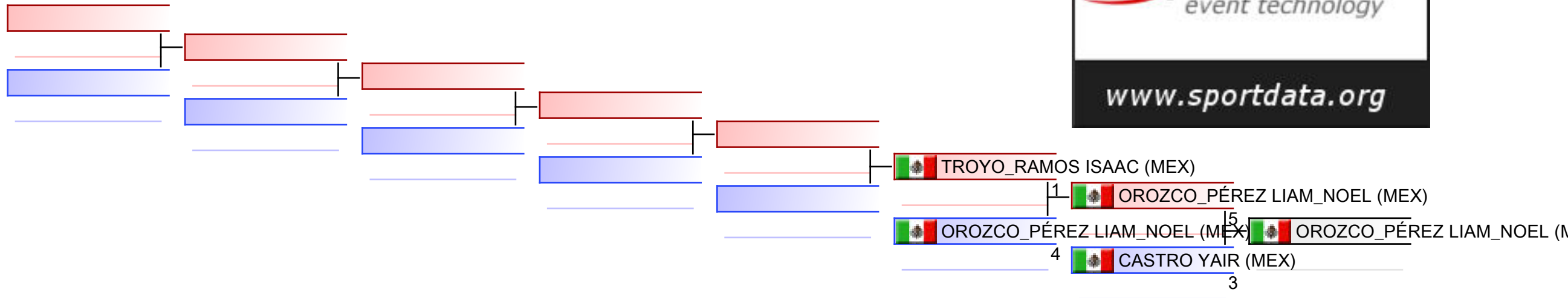

## REPECHAGE: (1)

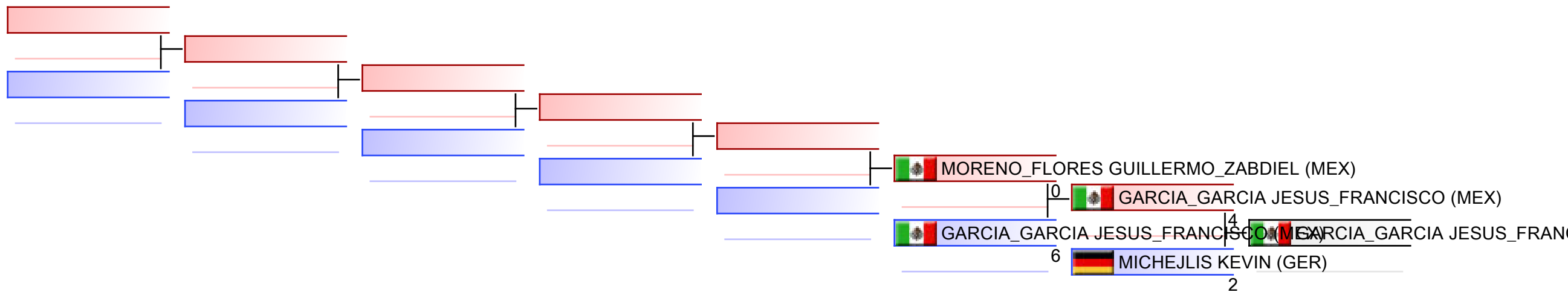

Referees:							
-----------	--	--	--	--	--	--	--



Karate1 Youth League - Acapulco 2022 - 2022-01-21  
Junior Kata Female

R1 G1/4 (8) Tatami 1 09:00

Competitors	Kata	1T	1A	2T	2A	3T	3A	4T	4A	5T	5A	6T	6A	7T	7A	TEC	ATH	Extra	Total	Rank
1 SWANSON KAITLIN (USA)	021 GOJUSHIHO SHO	7.4	7.2	(6.4)	(6.6)	7.0	6.8	7.8	7.6	(8.0)	(7.8)					15.54	6.48		22.024	
2 TAPIA_SOLANO IBETH_LILITH (MEX)	001 ANAN	6.8	6.6	(6.4)	(6.4)	6.8	6.6	(8.0)	(7.6)	7.2	7.0					14.56	6.06		20.626	
3 LOPEZ_NOROÑA SARA_ANELIS (MEX)	092 SUPARINPEI	7.8	7.8	(7.0)	(6.8)	8.0	7.8	(8.2)	7.8	8.2	(8.0)					16.8	7.02		23.822	
4 ZAMUDIO_FELIX YANETH (MEX)	067 PAIKU	7.0	6.8	(6.4)	(6.2)	7.2	6.6	(7.6)	(7.8)	6.6	6.8					14.56	6.06		20.627	
5 ANGULO_SOTO LIZBETH_GUADALUPE (MEX)	001 ANAN	(6.8)	7.0	6.8	(6.8)	7.4	6.8	(8.0)	(8.0)	8.0	7.8					15.54	6.48		22.025	
6 GALVAN_RODRIGUEZ DANNA (MEX)																				
7 VIERA_HERNANDEZ MAYRA_EMILY (MEX)	068 PAPUREN	(8.6)	(8.6)	(7.0)	(7.0)	8.4	8.2	8.2	8.2	8.4	8.2					17.5	7.38		24.881	
8 DENA_ALVAREZ JOANA_MARIA (MEX)	021 GOJUSHIHO SHO	8.0	(8.0)	(6.8)	(6.6)	7.6	7.6	8.0	7.8	(8.2)	8.0					16.52	7.02		23.543	

R1 G2/4 (7) Tatami 1 09:35

Competitors	Kata	1T	1A	2T	2A	3T	3A	4T	4A	5T	5A	6T	6A	7T	7A	TEC	ATH	Extra	Total	Rank
1 WILLIAMS DANNI (ENG)	068 PAPUREN	(8.4)	8.2	(7.2)	(7.2)	8.2	8.0	8.2	8.2	8.4	(8.4)					17.36	7.32		24.682	
2 MARTINEZ_ESCOBEDO AMERICA_VALERIA (MEX)	002 ANAN DAI	(8.2)	(8.0)	(7.2)	(7.0)	7.8	7.6	8.0	8.0	8.2	8.0					16.8	7.08		23.883	
3 MILLÁN ASTRID (MEX)	068 PAPUREN	7.2	7.0	(6.8)	(6.6)	7.4	7.0	7.2	7.4	(7.6)	(7.6)					15.26	6.42		21.687	
4 MARTINEZ_ZAPATA ANA_YURIDIA (MEX)	068 PAPUREN	(8.6)	(8.6)	(7.6)	(7.6)	8.0	8.0	8.2	8.4	8.6	8.6					17.36	7.5		24.861	
5 SANTOS_PAYAN LIZETH (MEX)	002 ANAN DAI	(7.8)	(7.6)	(7.2)	(7.0)	7.4	7.0	7.6	7.4	7.6	7.4					15.82	6.54		22.365	
6 SANTIAGO_SANCHEZ MARIA_FERNANDA (MEX)	068 PAPUREN	(6.6)	(6.4)	7.4	7.2	7.4	7.0	(7.6)	(7.4)	7.2	7.0					15.4	6.36		21.766	
7 LARIS_SANTOS DENISSE (MEX)	002 ANAN DAI	(8.0)	7.8	(7.2)	(7.2)	7.6	7.2	8.0	(8.2)	8.0	8.0					16.52	6.9		23.424	

R1 G3/4 (8) Tatami 2 09:00

Competitors	Kata	1T	1A	2T	2A	3T	3A	4T	4A	5T	5A	6T	6A	7T	7A	TEC	ATH	Extra	Total	Rank
1 KORMAN CHRISTINA (USA)	009 CHIBANA NO KUSHANKU	8.0	(8.2)	6.6	6.8	(5.8)	(6.2)	6.4	6.4	(8.2)	7.4					14.7	6.18		20.887	
2 PEREZ_MONTOYA HANNIA (MEX)	002 ANAN DAI	(7.6)	(7.6)	(6.4)	(6.6)	6.8	6.6	7.0	7.0	7.4	6.8					14.84	6.12		20.965	
3 TAGLIAFIERRO CHIARA (ITA)	009 CHIBANA NO KUSHANKU	7.4	7.6	(7.2)	(7.0)	7.6	7.8	7.2	7.4	(9.0)	(8.0)					15.54	6.84		22.382	
4 SOTO_TERRAZAS JUANA_PAOLA (MEX)	001 ANAN	6.8	6.8	6.2	6.4	(6.0)	(6.2)	6.6	6.8	(7.2)	(7.0)					13.72	6.0		19.728	
5 GARCIA_CORONEL SOFIA (VEN)	002 ANAN DAI	(7.0)	7.0	7.6	7.4	(7.8)	(8.0)	7.2	7.0	7.8	(6.8)					15.82	6.42		22.243	
6 VAZQUEZ_MOLINA JAZIVE_BENIGBÉ (MEX)	002 ANAN DAI	7.4	7.2	6.6	6.6	(6.2)	(6.0)	7.0	7.0	(8.0)	(7.4)					14.7	6.24		20.946	
7 MARTINEZ_RETA_FERNANDA (MEX)	002 ANAN DAI	7.2	7.0	6.8	(6.6)	(6.4)	6.6	7.4	7.0	(7.8)	(7.2)					14.98	6.18		21.164	
8 HUYET_DUMONG JUSTINE (FRA)	020 GOJUSHIHO DAI	(8.4)	(8.6)	7.8	7.8	(7.2)	7.8	7.2	(7.2)	7.6	7.4					15.82	6.9		22.721	

R1 G4/4 (7) Tatami 2 09:35

Competitors	Kata	1T	1A	2T	2A	3T	3A	4T	4A	5T	5A	6T	6A	7T	7A	TEC	ATH	Extra	Total	Rank
1 RIVERA AGUIRRE_ANNA_SOFIA (MEX)	021 GOJUSHIHO SHO	7.6	(7.8)	(6.4)	(6.6)	6.6	6.8	6.8	6.8	(7.8)	6.8					14.7	6.12		20.825	
2 MIÑANO LANYFER (SUI)	063 OHAN	8.2	8.0	7.6	7.8	8.0	(8.2)	(7.2)	(7.4)	(8.8)	8.0					16.66	7.14		23.8	1
3 ALQUINTA NABEEL (CHI)	015 GANKAKU	(7.4)	(7.0)	6.6	6.8	(5.8)	(5.6)	6.6	6.4	7.4	6.6					14.42	5.94		20.367	
4 NACU MAILLE (USA)	020 GOJUSHIHO DAI	8.0	7.8	7.4	7.4	(6.8)	(7.0)	7.2	7.0	(9.2)	(8.4)					15.82	6.66		22.483	
5 CLOW AMELIA (ENG)	002 ANAN DAI	7.6	(7.6)	6.8	6.6	(6.0)	(6.2)	6.4	6.8	(8.0)	7.2					14.56	6.18		20.746	
6 OCANA LAYLA (USA)	097 TOMARI BASSAI	8.2	(7.8)	7.6	7.8	(6.6)	(6.8)	6.8	6.8	(8.4)	7.8					15.82	6.72		22.542	
7 ESPIRITO_SANTO DIAS NICOLE (USA)	009 CHIBANA NO KUSHANKU	8.0	(8.0)	7.4	7.4	(6.8)	(7.0)	7.0	7.0	(8.2)	7.8					15.68	6.66		22.344	

R2-G1

Competitors	Kata	1T	1A	2T	2A	3T	3A	4T	4A	5T	5A	6T	6A	7T	7A	TEC	ATH	Extra	Total	Rank
1 WILLIAMS DANNI (ENG)	002 ANAN DAI	(8.4)	(8.4)	(7.6)	(7.4)	8.4	8.4	8.2	8.2	8.2	8.2					17.36	7.44		24.8	1
2 MARTINEZ_ESCOBEDO AMERICA_VALERIA (MEX)	047 KURURUNFA	7.8	7.6	(7.4)	(7.2)	8.0	7.8	8.0	7.8	(8.2)	(8.0)					16.66	6.96		23.624	
3 MARTINEZ_ZAPATA ANA_YURIDIA (MEX)	092 SUPARINPEI	(8.4)	(8.4)	(7.6)	(7.4)	8.0	7.4	7.8	8.0	8.2	8.0					16.8	7.02		23.823	
4 LARIS_SANTOS DENISSE (MEX)	001 ANAN	7.8	(7.8)	(7.4)	(7.2)	7.6	7.6	(8.0)	7.6	8.0	7.8					16.38	6.9		23.285	
5 LOPEZ_NOROÑA SARA_ANELIS (MEX)	047 KURURUNFA	7.6	7.4	(7.0)	(7.0)	7.4	7.8	7.8	7.6	(8.2)	(8.0)					15.96	6.84		22.8	7
6 VIERA_HERNANDEZ MAYRA_EMILY (MEX)	092 SUPARINPEI	(8.6)	(8.8)	(7.6)	(7.4)	8.2	8.0	8.0	8.0	8.4	8.2					17.22	7.26		24.482	
7 SWANSON KAITLIN (USA)	015 GANKAKU	7.8	7.6	(7.2)	(7.0)	7.4	7.2	7.6	7.4	(8.0)	(7.8)					15.96	6.66		22.628	
8 DENA_ALVAREZ JOANA_MARIA (MEX)	012 ENPI	(8.0)	7.8	(7.4)	(7.2)	7.6	7.2	7.8	7.8	7.8	(8.0)					16.24	6.84		23.086	

R2-G2

Competitors	Kata	1T	1A	2T	2A	3T	3A	4T	4A	5T	5A	6T	6A	7T	7A	TEC	ATH	Extra	Total	Rank
1 TAGLIAFIERRO CHIARA (ITA)	002 ANAN DAI	7.2	7.4	7.8	(8.0)	(8.0)	7.8	(7.0)	(7.2)	7.4	7.8					15.68	6.9		22.584	
2 HUYET_DUMONG JUSTINE (FRA)	041 KANKU SHO	(6.8)	7.2	7.2	7.4	(8.4)	(8.2)	6.8	(6.6)	7.2	7.4					14.84	6.6		21.447	



## Karate1 Youth League - Acapulco 2022 - 2022-01-21 Junior Kata Female

3	NACU MAILE (USA)	099 UNSU	7.0	7.0	(6.2)	6.4	(8.0)	(7.8)	6.2	(5.8)	7.0	6.8					14.14	6.06	20.2	8
4	MARTINEZ RETA_FERNANDA (MEX)	068 PAPUREN	7.6	7.4	(7.2)	(7.0)	8.0	8.0	(9.2)	(8.6)	7.6	7.4					16.24	6.84	23.08	3
5	OCANA LAYLA (USA)	009 CHIBANA NO KUSHANKU	7.6	(7.8)	(6.8)	(7.0)	(7.8)	7.4	7.8	7.4	7.0	7.0					15.68	6.54	22.22	5
6	ESPIRITO_SANTO DIAS NICOLE (USA)	092 SUPARINPEI	7.8	7.4	(6.6)	(6.8)	(8.4)	(8.6)	7.4	6.8	7.2	7.2					15.68	6.42	22.1	6
7	GARCIA_CORONEL SOFIA (VEN)	001 ANAN	8.0	(7.6)	8.0	8.0	8.0	7.8	(9.6)	(9.6)	(7.6)	7.6					16.8	7.02	23.82	2
8	MIÑANO LANYFER (SUI)	002 ANAN DAI	7.8	7.8	8.2	8.0	8.2	8.4	(8.4)	(8.8)	(7.4)	(7.6)					16.94	7.26	24.2	1

### R3-G1

Competitors	Kata	1T	1A	2T	2A	3T	3A	4T	4A	5T	5A	6T	6A	7T	7A	TEC	ATH	Extra	Total Rank	
1 MARTINEZ_ZAPATA ANA_YURIDIA (MEX)	008 CHATANYARA KUSHANKU	(8.4)	(8.4)	(7.6)	(7.6)	8.4	8.2	8.2	7.8	8.2	8.2					17.36	7.26		24.62	2
2 VIERA_HERNANDEZ MAYRA_EMILY (MEX)	008 CHATANYARA KUSHANKU	(8.6)	(8.4)	(7.6)	(7.4)	8.6	8.2	8.2	8.0	8.0	8.2					17.36	7.32		24.68	1
3 MARTINEZ_ESCOBEDO AMERICA_VALERIA (MEX)	068 PAPUREN	7.6	7.4	(7.4)	(7.2)	7.8	7.8	7.8	7.8	(8.0)	(8.2)					16.24	6.9		23.14	3
4 WILLIAMS DANNI (ENG)	001 ANAN																			

### R3-G2

Competitors	Kata	1T	1A	2T	2A	3T	3A	4T	4A	5T	5A	6T	6A	7T	7A	TEC	ATH	Extra	Total Rank	
1 MARTINEZ RETA_FERNANDA (MEX)	008 CHATANYARA KUSHANKU	(8.2)	(7.8)	(6.4)	(6.6)	8.0	7.6	7.4	6.6	7.6	7.4					16.1	6.48		22.58	4
2 MIÑANO LANYFER (SUI)	068 PAPUREN	8.4	(8.0)	8.4	8.2	(8.6)	(8.6)	8.0	8.6	(7.8)	8.0					17.36	7.44		24.8	2
3 TAGLIAFIERRO CHIARA (ITA)	008 CHATANYARA KUSHANKU	(8.4)	8.6	8.2	8.0	8.2	8.4	8.4	(9.4)	(7.2)	(7.6)					17.36	7.5		24.86	1
4 GARCIA_CORONEL SOFIA (VEN)	009 CHIBANA NO KUSHANKU	(8.6)	8.4	8.0	8.2	8.2	8.4	8.2	(9.2)	(7.2)	(7.4)					17.08	7.5		24.58	3

### R4 Bronze Medal Match 1

Competitors	Kata	1T	1A	2T	2A	3T	3A	4T	4A	5T	5A	6T	6A	7T	7A	TEC	ATH	Extra	Total Rank	
1 MARTINEZ_ZAPATA ANA_YURIDIA (MEX)	043 KISHIMOTO NO KUSHANKU	(8.6)	(8.8)	(7.6)	(7.6)	8.2	8.2	8.2	8.0	8.2	8.0					17.22	7.26		24.48	2
2 GARCIA_CORONEL SOFIA (VEN)	064 OHAN DAI	(8.4)	(8.2)	(7.4)	(7.4)	8.4	8.2	8.2	8.2	8.0	8.0					17.22	7.32		24.54	1

### R4 Bronze Medal Match 2 Tatami 2 10:55

Competitors	Kata	1T	1A	2T	2A	3T	3A	4T	4A	5T	5A	6T	6A	7T	7A	TEC	ATH	Extra	Total Rank	
1 MARTINEZ_ESCOBEDO AMERICA_VALERIA (MEX)	092 SUPARINPEI	8.2	7.8	(7.2)	(7.0)	8.4	8.2	(8.6)	7.8	8.6	(8.4)					17.64	7.14		24.78	2
2 MIÑANO LANYFER (SUI)	064 OHAN DAI	8.8	(9.2)	(8.4)	(8.2)	8.8	8.8	(9.0)	8.6	8.8	8.6					18.48	7.8		26.28	1

### R4 Gold Medal Match

Competitors	Kata	1T	1A	2T	2A	3T	3A	4T	4A	5T	5A	6T	6A	7T	7A	TEC	ATH	Extra	Total Rank	
1 VIERA_HERNANDEZ MAYRA_EMILY (MEX)	001 ANAN	(8.6)	(8.4)	(7.6)	(7.4)	8.2	8.4	8.2	8.4	8.0	8.2					17.08	7.5		24.58	1
2 TAGLIAFIERRO CHIARA (ITA)	068 PAPUREN	(8.8)	8.2	(7.6)	(7.6)	7.8	8.0	8.0	8.2	8.2	(8.4)					16.8	7.32		24.12	2

### Results

1	VIERA HERNANDEZ MAYRA EMILY		MEXICO
2	TAGLIAFIERRO CHIARA		ITALY
3	GARCIA CORONEL SOFIA		VENEZUELA
3	MIÑANO LANYFER		SWITZERLAND



## Karate1 Youth League - Acapulco 2022 - 2022-01-21 Junior Kata Male

### R1 G1/2 (9) Tatami 1 11:20

Competitors	Kata	1T	1A	2T	2A	3T	3A	4T	4A	5T	5A	6T	6A	7T	7A	TEC	ATH	Extra	Total	Rank
1 RETIZ_CAMPOS RODRIGO_ADRIAN (MEX)	002 ANAN DAI	7.6	7.4	(6.8)	(6.6)	7.6	7.6	(7.8)	(7.8)	7.6	7.4					15.96	6.72		22.68	4
2 BERRETTA DYLAN (CAN)	008 CHATANYARA KUSHANKU	(7.8)	7.4	(7.0)	(6.8)	7.8	(8.0)	7.6	7.8	7.8	7.6					16.24	6.84		23.08	3
3 MADRID TAPIA_RODRIGO_ALEJANDRO (USA)	047 KURURUNFA	(8.4)	(8.6)	(7.2)	(7.2)	8.4	8.4	8.4	8.0	8.0	8.0					17.36	7.32		24.68	1
4 SAGILYAN EDUARD (USA)	099 UNSU	7.4	7.6	(6.8)	(6.8)	(8.2)	(8.2)	8.0	8.0	8.2	8.0					16.52	7.08		23.6	2
5 VEGA_BATIZ CARLOS_SANTIAGO (MEX)	092 SUPARINPEI	8.0	7.6	(6.6)	(6.6)	(8.2)	(8.4)	7.2	7.4	7.4	7.6					15.82	6.78		22.6	5
6 LOK AIDAN (USA)	048 KUSANKU	7.2	7.0	(6.8)	(6.8)	(7.4)	(7.6)	7.0	7.4	7.4	7.2					15.12	6.48		21.6	7
7 CASTRO_SEGURA ERIC_GIOVANNI (MEX)	068 PAPUREN	(7.4)	6.8	6.8	6.6	7.4	(7.2)	6.8	7.2	(6.4)	(6.2)					14.7	6.18		20.88	8
8 DOMINGUEZ DANIEL (PAN)	008 CHATANYARA KUSHANKU	7.6	(7.6)	(6.8)	(6.8)	7.2	7.4	7.4	7.2	(7.8)	7.6					15.54	6.66		22.2	6
9 DIAZ_MAYTORENA PEDRO_MARIO (MEX)	068 PAPUREN	(6.6)	6.4	6.2	6.2	6.6	(6.6)	6.4	6.2	(6.0)	(6.0)					13.44	5.64		19.08	9

### R1 G2/2 (8) Tatami 2 11:10

Competitors	Kata	1T	1A	2T	2A	3T	3A	4T	4A	5T	5A	6T	6A	7T	7A	TEC	ATH	Extra	Total	Rank
1 GRANADOS_HERRERA OSCAR_RENE (ESA)	001 ANAN	(6.6)	7.0	(8.2)	(8.4)	6.8	7.0	6.6	(6.8)	7.6	7.6					14.7	6.48		21.18	8
2 NEAL JACKSON (USA)	009 CHIBANA NO KUSHANKU	6.8	7.2	7.4	(7.6)	7.0	7.4	(5.8)	(6.2)	(7.6)	7.4					14.84	6.6		21.44	7
3 ONAGA TROY (USA)	002 ANAN DAI	(7.4)	(7.4)	(8.4)	7.6	7.8	7.6	8.0	(8.2)	8.0	8.0					16.66	6.96		23.62	1
4 SALAS_ALONSO LUIS_LEONARDO (MEX)	008 CHATANYARA KUSHANKU	6.6	(6.6)	7.6	(7.6)	7.4	7.2	(6.4)	6.6	(7.8)	7.6					15.12	6.42		21.54	6
5 CASTILLO_RAMOS RODRIGO (MEX)	041 KANKU SHO	7.2	7.4	(8.0)	7.8	8.0	(8.2)	(6.8)	(7.0)	8.0	8.2					16.24	7.02		23.26	2
6 ADI DAVID (USA)	099 UNSU	7.0	7.2	7.6	7.2	7.2	7.2	(6.0)	(6.2)	(8.2)	(8.0)					15.26	6.48		21.74	5
7 PAEZ JOAQUIN (ECU)	099 UNSU	7.6	7.6	(7.2)	(7.4)	7.4	7.6	8.2	8.0	(8.6)	(8.4)					16.24	6.96		23.2	3
8 SALDAÑA_MARKUS EMILIO (MEX)	002 ANAN DAI	(7.0)	(7.0)	7.4	8.0	8.0	7.8	(8.4)	(8.2)	7.8	7.4					16.24	6.96		23.2	4

### R2-G1

Competitors	Kata	1T	1A	2T	2A	3T	3A	4T	4A	5T	5A	6T	6A	7T	7A	TEC	ATH	Extra	Total	Rank
1 MADRID TAPIA_RODRIGO_ALEJANDRO (USA)	064 OHAN DAI	(8.4)	(8.4)	(7.2)	(7.0)	8.2	8.4	7.8	7.6	7.4	7.6					16.38	7.08		23.46	1
2 SAGILYAN EDUARD (USA)	041 KANKU SHO	(6.8)	(7.0)	7.2	7.2	(7.8)	(7.8)	7.4	7.2	7.4	7.2					15.4	6.48		21.88	4
3 BERRETTA DYLAN (CAN)	068 PAPUREN	8.0	7.8	7.4	7.2	(8.2)	(8.0)	7.4	7.2	(6.6)	(6.8)					15.96	6.66		22.62	2
4 RETIZ_CAMPOS RODRIGO_ADRIAN (MEX)	002 ANAN DAI	7.8	(7.8)	(6.8)	(7.0)	6.8	7.0	(8.0)	7.8	7.4	7.2					15.4	6.6		22.0	3

### R2-G2

Competitors	Kata	1T	1A	2T	2A	3T	3A	4T	4A	5T	5A	6T	6A	7T	7A	TEC	ATH	Extra	Total	Rank
1 PAEZ JOAQUIN (ECU)	015 GANKAKU	8.0	8.2	(8.6)	(8.6)	(7.6)	(7.6)	8.4	8.4	8.6	8.6					17.5	7.56		25.06	1
2 ONAGA TROY (USA)	008 CHATANYARA KUSHANKU	7.6	7.8	8.4	8.6	(7.4)	(7.4)	8.6	8.4	(9.4)	(9.4)					17.22	7.44		24.66	2
3 CASTILLO_RAMOS RODRIGO (MEX)	099 UNSU	(6.8)	(7.2)	8.2	8.4	7.6	7.4	8.4	(8.6)	(8.8)	8.4					16.94	7.26		24.2	4
4 SALDAÑA_MARKUS EMILIO (MEX)	064 OHAN DAI	8.2	8.2	8.0	7.8	(7.2)	(7.2)	(8.8)	8.6	8.2	(9.2)					17.08	7.38		24.46	3

### R3 Bronze Medal Match 1

Competitors	Kata	1T	1A	2T	2A	3T	3A	4T	4A	5T	5A	6T	6A	7T	7A	TEC	ATH	Extra	Total	Rank
1 BERRETTA DYLAN (CAN)	002 ANAN DAI	8.0	7.8	(7.2)	(7.2)	(8.2)	(8.4)	7.8	7.6	7.4	7.6					16.24	6.9		23.14	2
2 SALDAÑA_MARKUS EMILIO (MEX)	063 OHAN	(8.4)	8.2	(7.2)	(7.0)	8.4	(8.4)	8.0	7.8	8.0	8.2					17.08	7.26		24.34	1

### R3 Bronze Medal Match 2

Competitors	Kata	1T	1A	2T	2A	3T	3A	4T	4A	5T	5A	6T	6A	7T	7A	TEC	ATH	Extra	Total	Rank
1 RETIZ_CAMPOS RODRIGO_ADRIAN (MEX)	064 OHAN DAI	(8.6)	(8.4)	7.6	7.6	(7.0)	(6.8)	8.4	8.4	7.8	7.6					16.66	7.08		23.74	1
2 ONAGA TROY (USA)	009 CHIBANA NO KUSHANKU	(8.8)	(8.2)	8.0	8.0	(7.4)	(7.2)	8.2	8.0	7.4	7.2					16.52	6.96		23.48	2

### R3 Gold Medal Match



Competitors	Kata	1T	1A	2T	2A	3T	3A	4T	4A	5T	5A	6T	6A	7T	7A	TEC	ATH	Extra	Total	Rank
1 MADRID TAPIA_RODRIGO_ALEJANDRO (USA)	002 ANAN DAI	(8.6)	(8.4)	(7.4)	(7.2)	8.4	8.4	8.2	8.0	7.8	8.0					17.08	7.32		24.4	1
2 PAEZ JOAQUIN (ECU)	020 GOJUSHIHO DAI	8.0	8.0	(6.8)	(6.8)	(8.6)	(8.6)	8.0	7.8	8.2	8.0					16.94	7.14		24.08	2

### Results

1	MADRID TAPIA RODRIGO ALEJANDRO		UNITED STATES
2	PAEZ JOAQUIN		ECUADOR



Karate1 Youth League - Acapulco 2022 - 2022-01-21  
Junior Kata Male

3	SALDANA MARKUS EMILIO		MEXICO
3	RETIZ CAMPOS RODRIGO ADRIAN		MEXICO

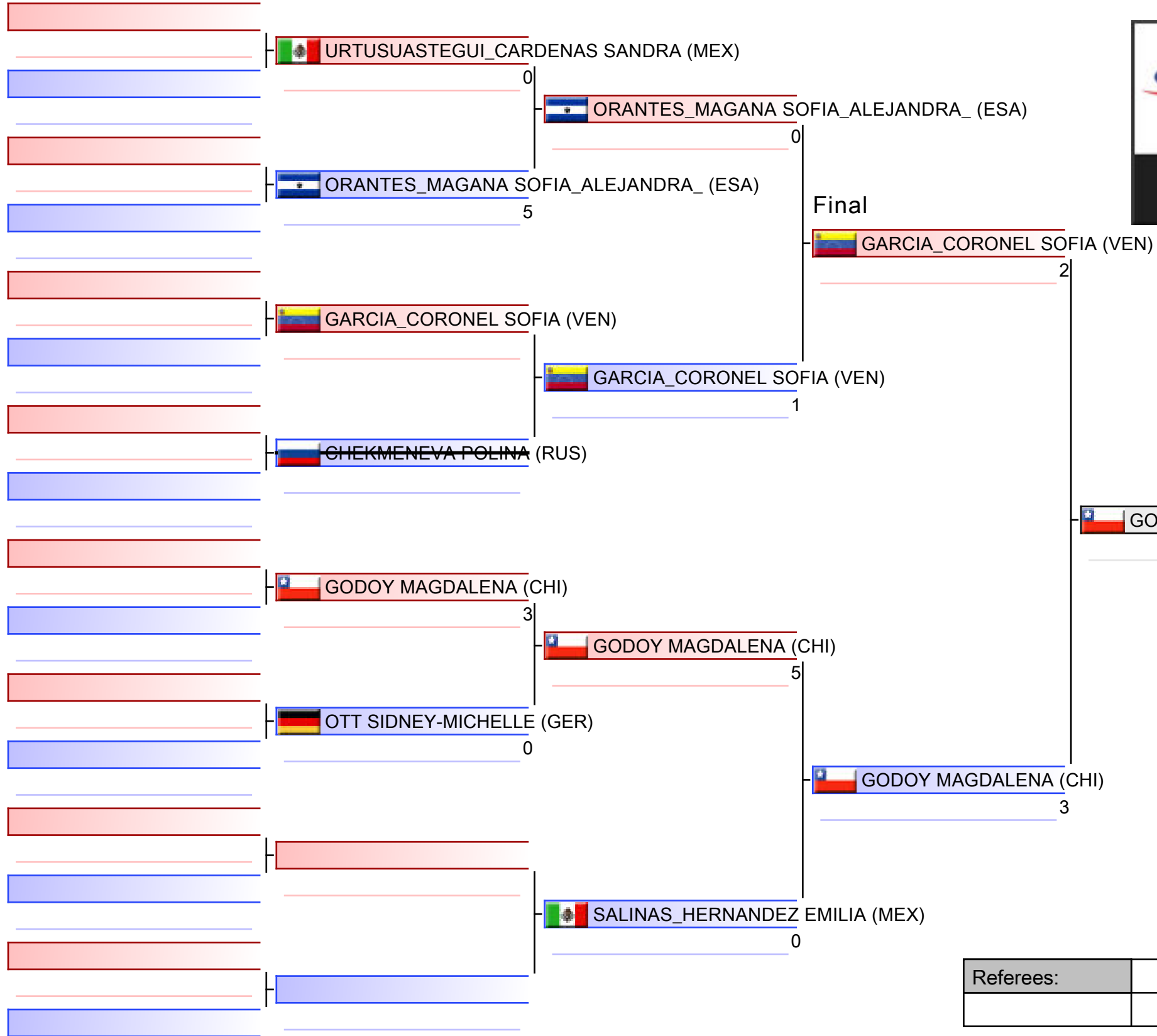

1. GODOY MAGDALENA (CHI)
2. GARCIA_CORONEL SOFIA (VEN)
3. ORANTES_MAGANA SOFIA_ALEJANDRA_ (ESA)
3. OTT SIDNEY-MICHELLE (GER)
5. SALINAS_HERNANDEZ EMILIA (MEX)

Referees:			

# Junior Kumite Female -48 kg

Karate1 Youth League - Acapulco 2022

Tatami  
3 11:25

Pool  
1

(c)sportdata GmbH & Co KG 2000-2022(2022-01-23 12:44) -WKF Approved- v 9.8.8 build 3 (2021-11-04) License: Online\_Event\_ID-560\_Karate1YouthLeagueAcapulco2022 (expire 2022-02-06)

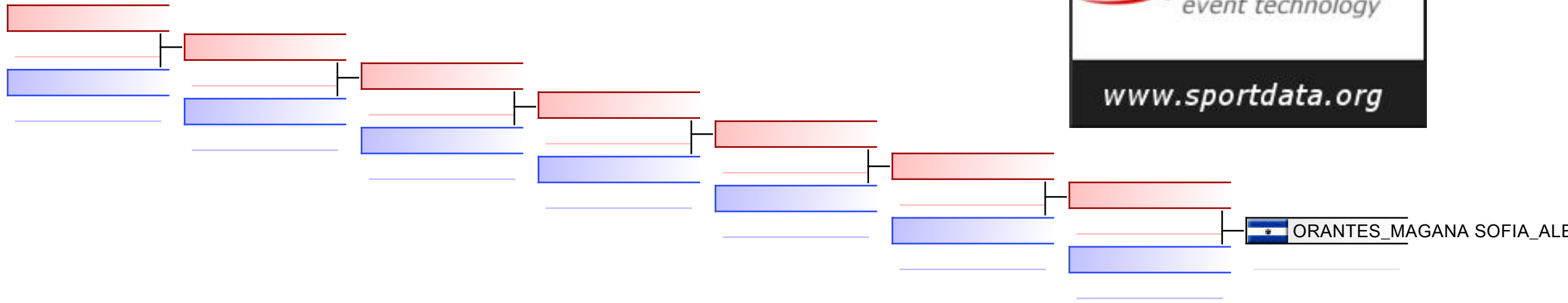

## REPECHAGE: (1)

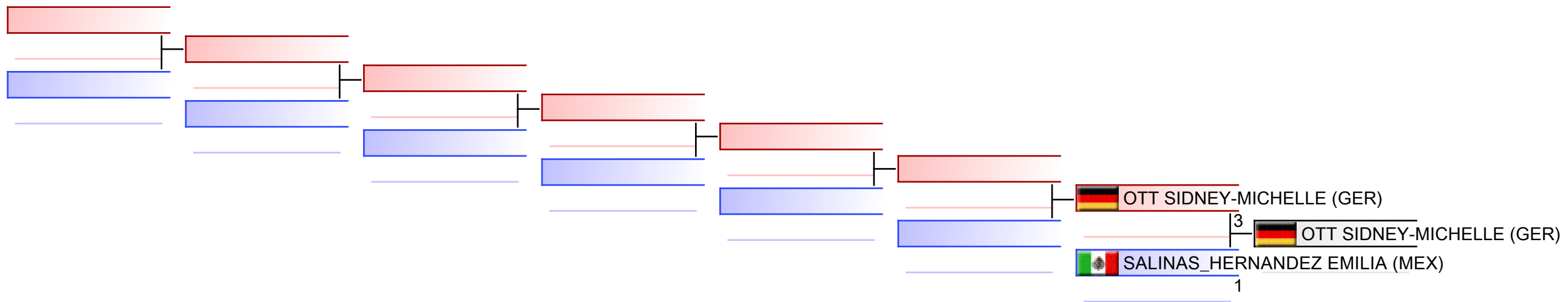

Referees:							
-----------	--	--	--	--	--	--	--



# Junior Kumite Female -53 kg

Karate1 Youth League - Acapulco 2022, Acapulco, MEX

Tatami  
2 12:25

Pool  
1/1

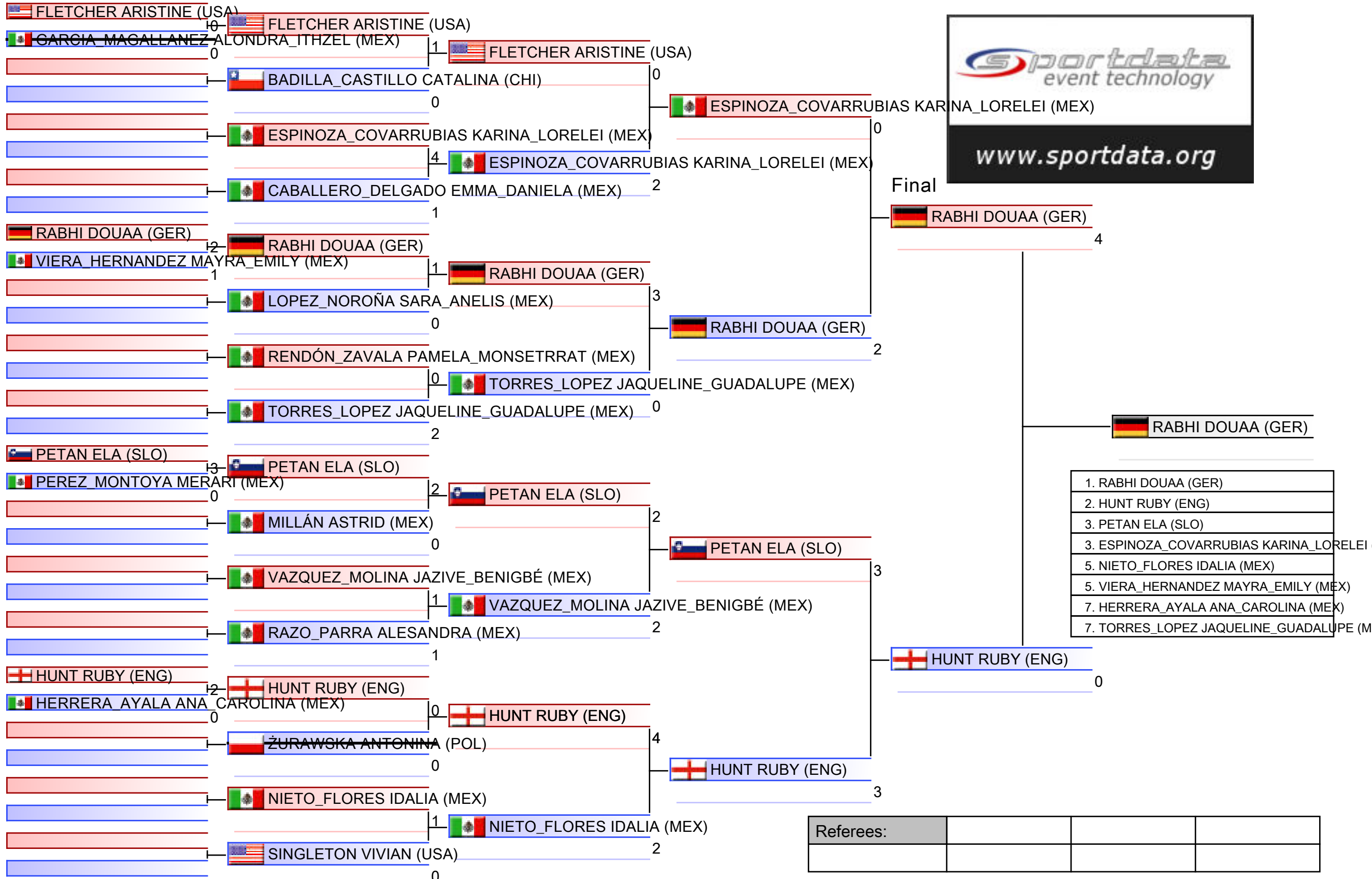

# Junior Kumite Female -53 kg

Karate1 Youth League - Acapulco 2022

Tatami  
2 13:40

Pool  
1

(c)sportdata GmbH & Co KG 2000-2022(2022-01-23 12:44) -WKF Approved- v 9.8.8 build 3 (2021-11-04) License: Online\_Event\_ID-560\_Karate1YouthLeagueAcapulco2022 (expire 2022-02-06)

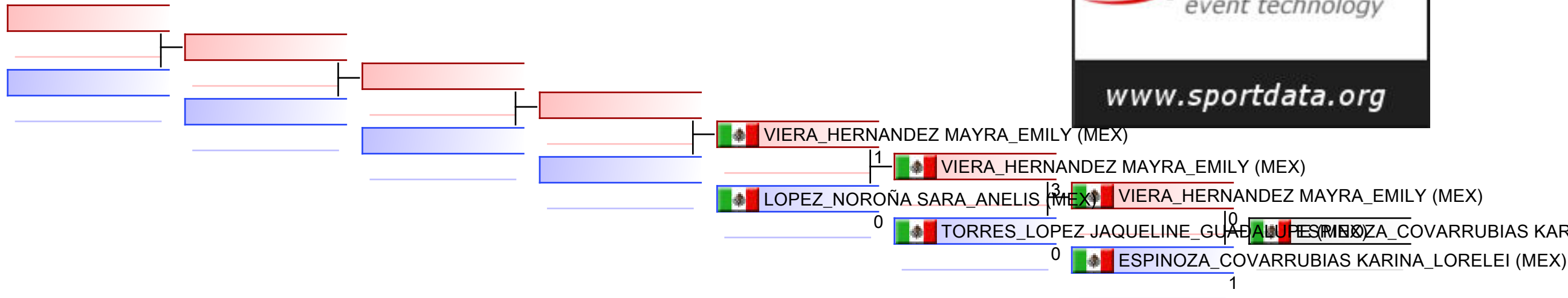

## REPECHAGE: (1)

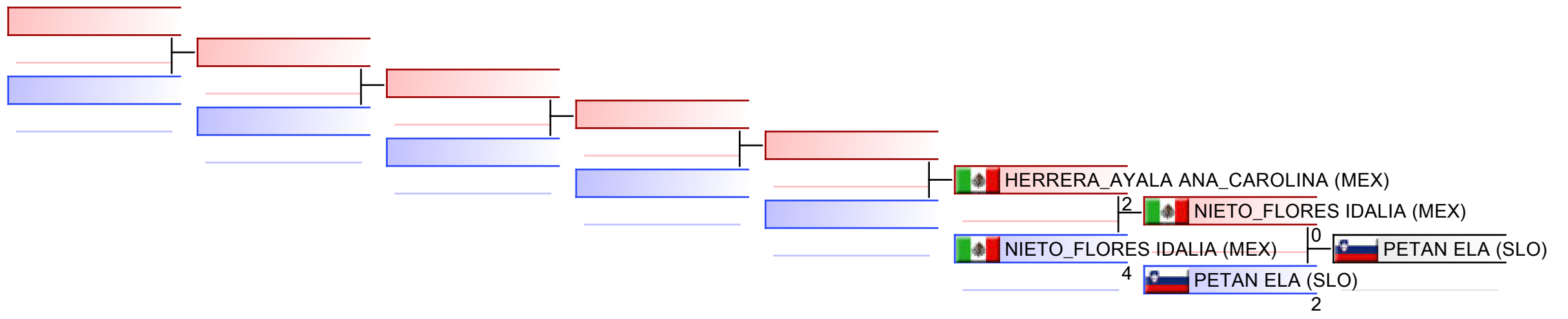

Referees:							
-----------	--	--	--	--	--	--	--

# Junior Kumite Female -59 kg

Karate1 Youth League - Acapulco 2022, Acapulco, MEX

Tatami  
3 12:45

Pool  
1/1

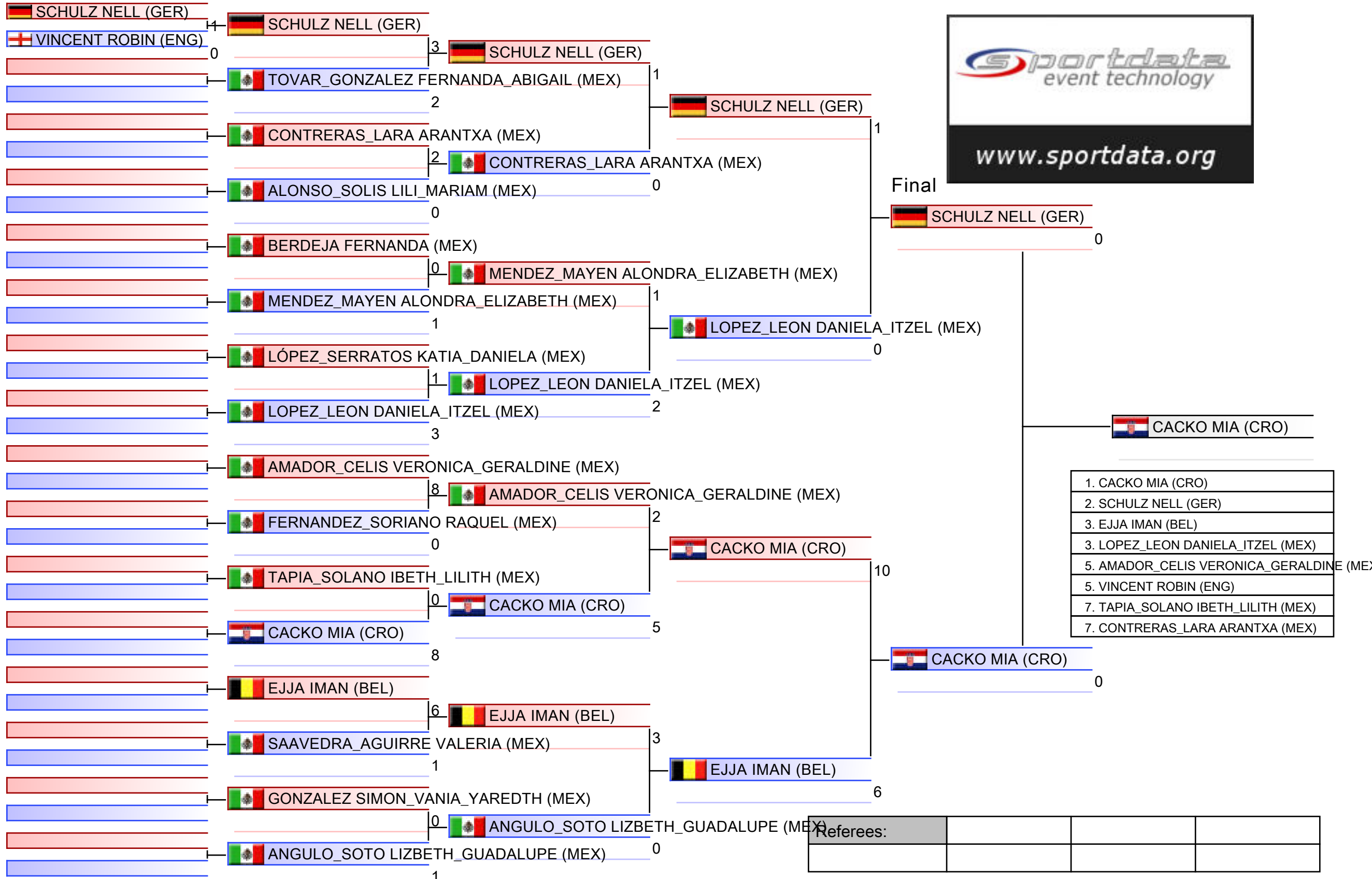

# Junior Kumite Female -59 kg

Karate1 Youth League - Acapulco 2022

Tatami  
3 13:45

Pool  
1

(c)sportdata GmbH & Co KG 2000-2022(2022-01-23 12:44) -WKF Approved- v 9.8.8 build 3 (2021-11-04) License: Online\_Event\_ID-560\_Karate1YouthLeagueAcapulco2022 (expire 2022-02-06)

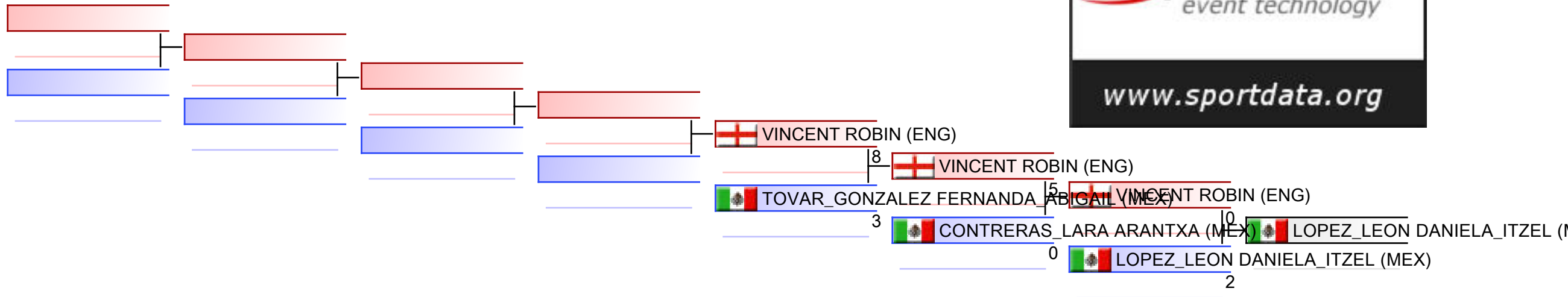

## REPECHAGE: (1)

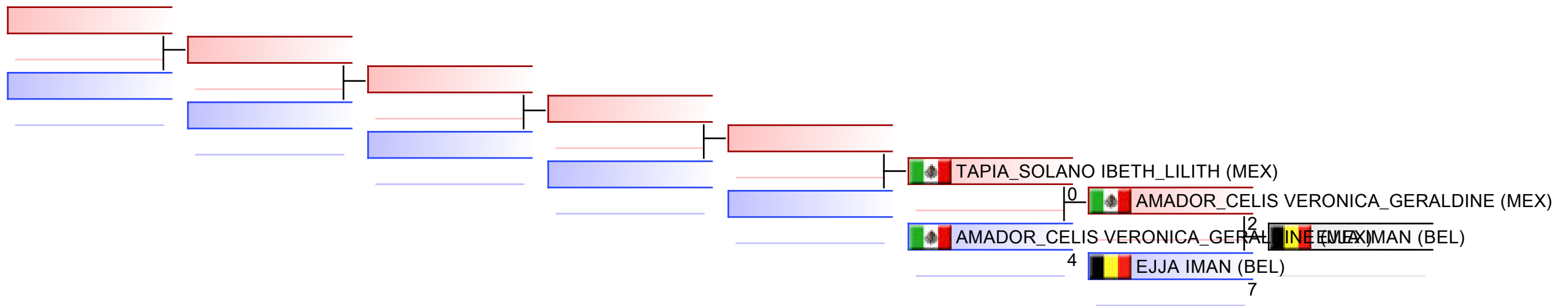

Referees:							
-----------	--	--	--	--	--	--	--

# Junior Kumite Female 59+ kg

Karate1 Youth League - Acapulco 2022, Acapulco, MEX

Tatami  
3 11:45

Pool  
1/1

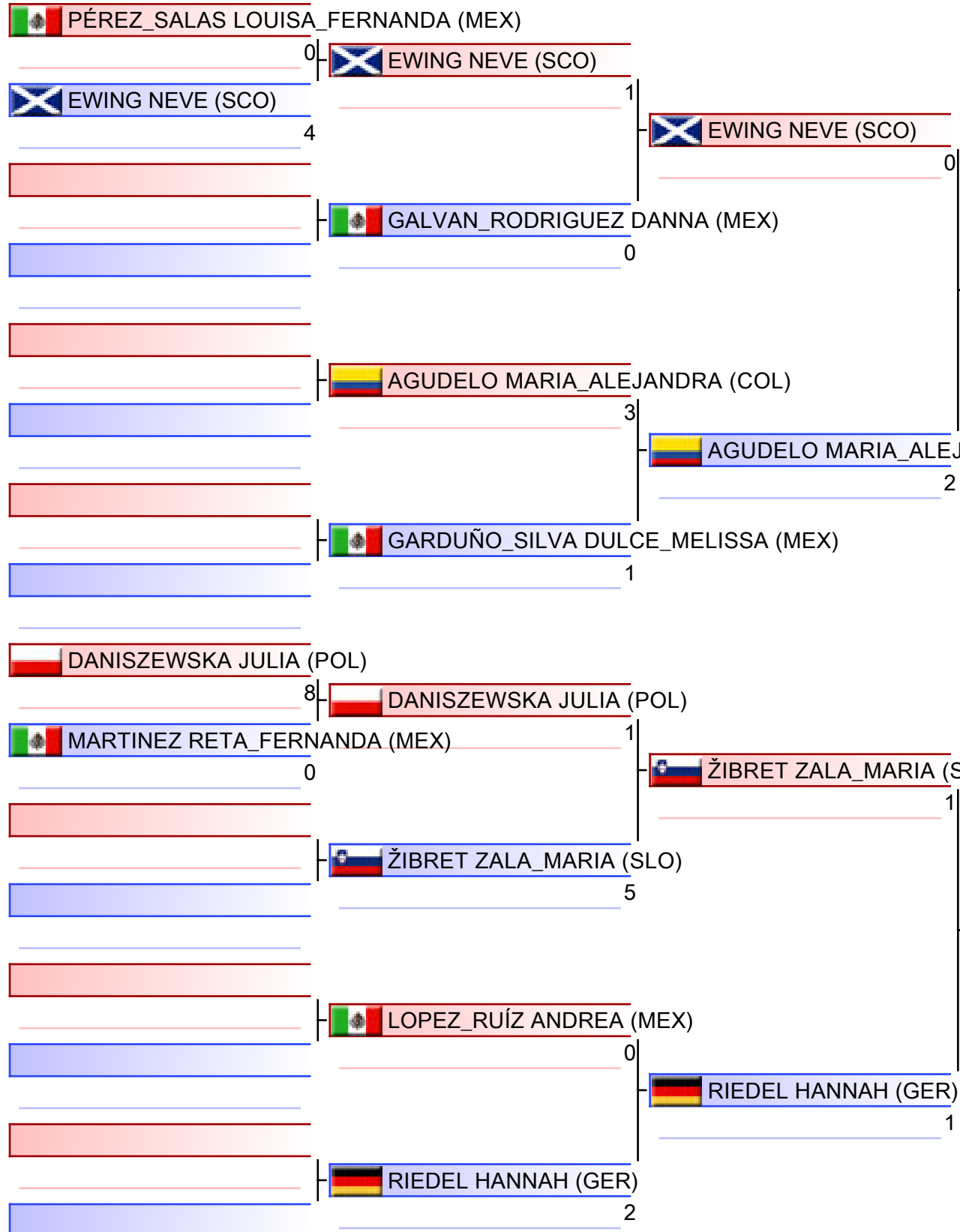

1. AGUDELO MARIA_ALEJANDRA (COL)
2. ŽIBRET ZALA_MARIA (SLO)
3. EWING NEVE (SCO)
3. DANISZEWSKA JULIA (POL)
5. GARDUÑO_SILVA DULCE_MELISSA (MEX)
5. RIEDEL HANNAH (GER)

Referees:			

# Junior Kumite Female 59+ kg

Karate1 Youth League - Acapulco 2022

Tatami  
3 12:20

Pool  
1

(c)sportdata GmbH & Co KG 2000-2022(2022-01-23 12:44) -WKF Approved- v 9.8.8 build 3 (2021-11-04) License: Online\_Event\_ID-560\_Karate1YouthLeagueAcapulco2022 (expire 2022-02-06)

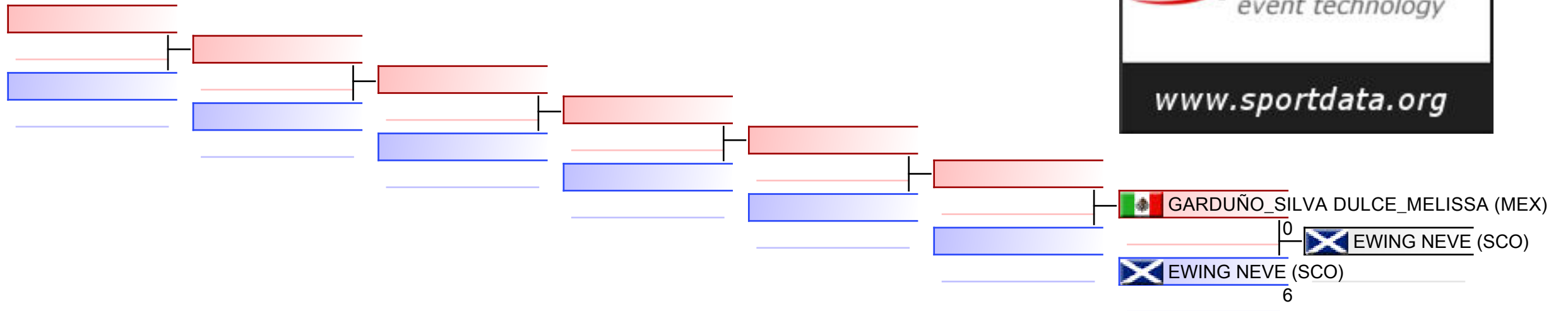

## REPECHAGE: (1)

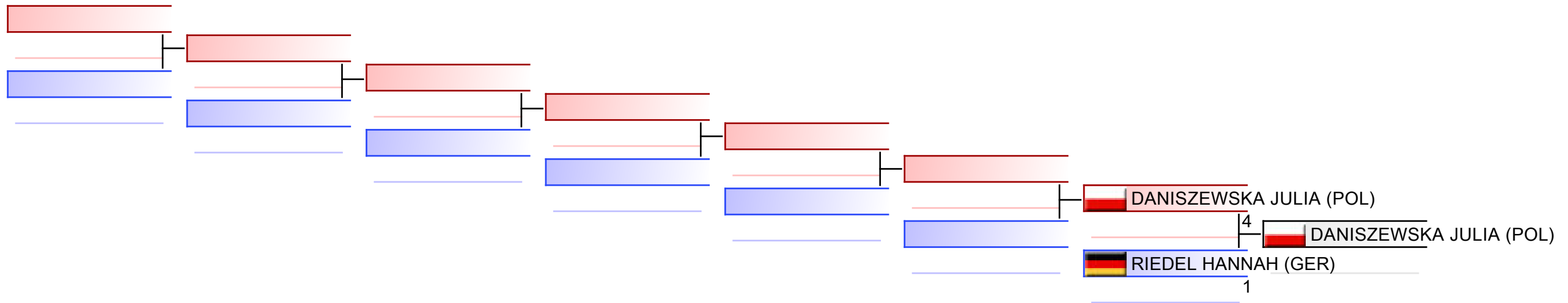

Referees:							
-----------	--	--	--	--	--	--	--

# Junior Kumite Male -55 kg

Karate1 Youth League - Acapulco 2022, Acapulco, MEX

Tatami  
1 13:45

Pool  
1/1

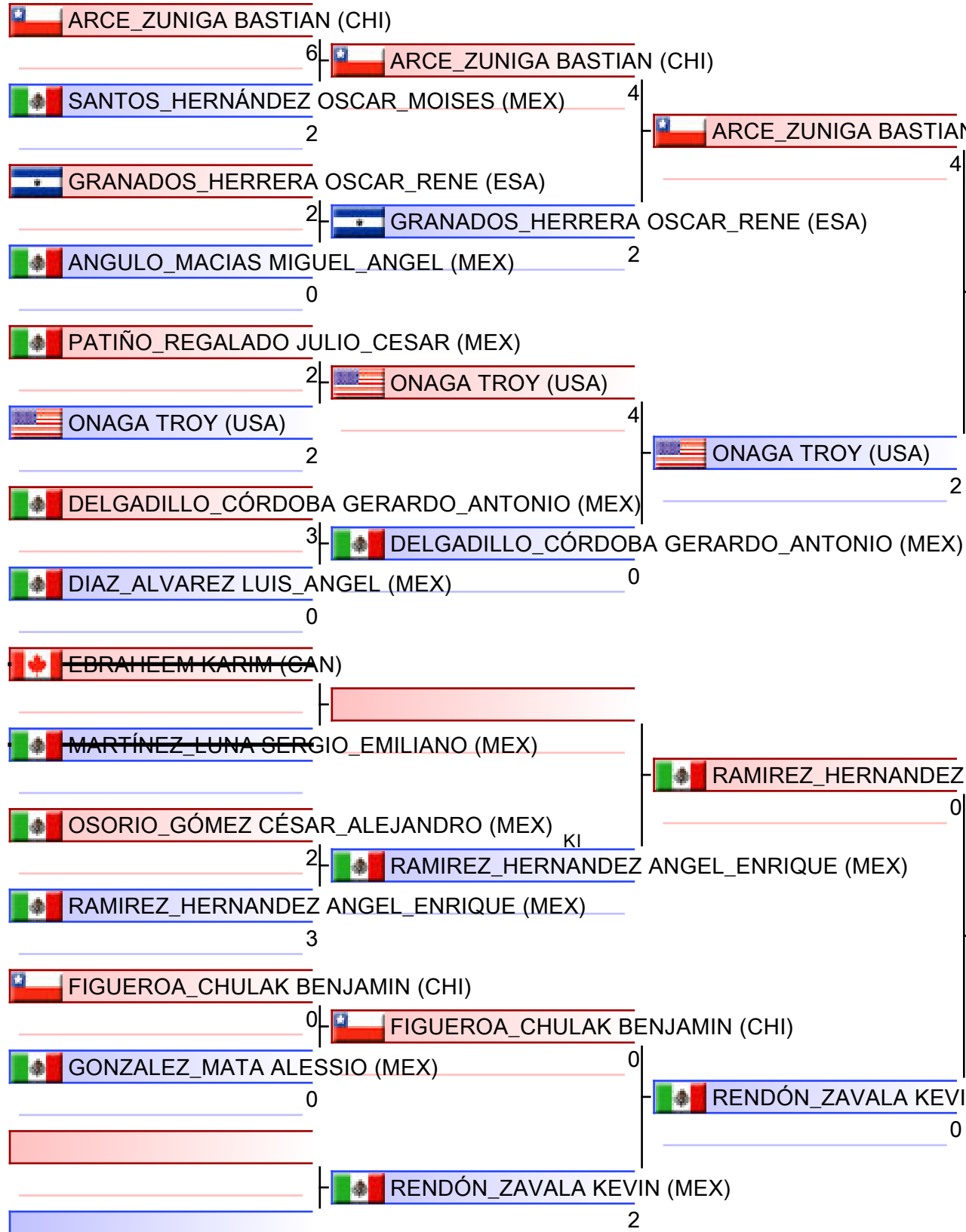

- |  |
|--|
| 1. ARCE_ZUNIGA BASTIAN (CHI)             |
| 2. RENDÓN_ZAVALA KEVIN (MEX)             |
| 3. FIGUEROA_CHULAK BENJAMIN (CHI)        |
| 3. ONAGA TROY (USA)                      |
| 5. RAMIREZ_HERNANDEZ ANGEL_ENRIQUE (MEX) |
| 5. GRANADOS_HERRERA OSCAR_RENE (ESA)     |
| 7. SANTOS_HERNÁNDEZ OSCAR_MOISES (MEX)   |

Referees:			

# Junior Kumite Male -55 kg

Karate1 Youth League - Acapulco 2022

Tatami  
1 14:40

Pool  
1

(c)sportdata GmbH & Co KG 2000-2022(2022-01-23 12:44) -WKF Approved- v 9.8.8 build 3 (2021-11-04) License: Online\_Event\_ID-560\_Karate1YouthLeagueAcapulco2022 (expire 2022-02-06)

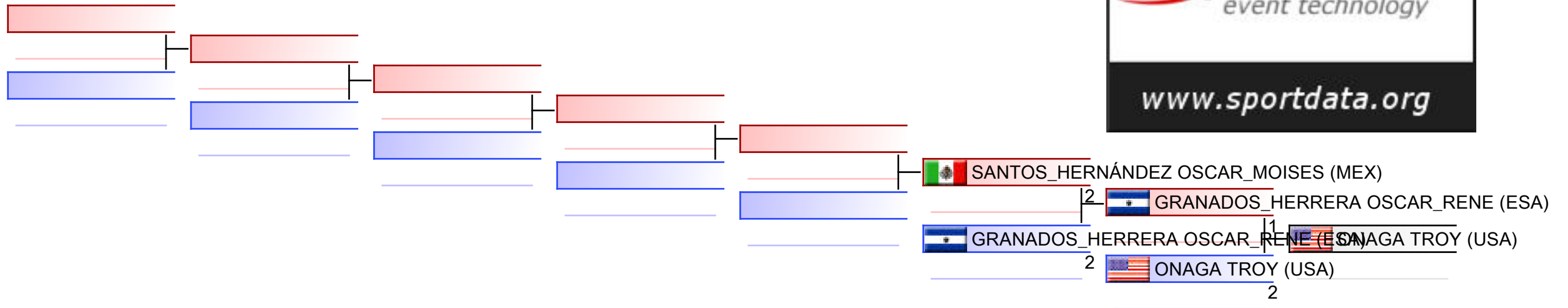

## REPECHAGE: (1)

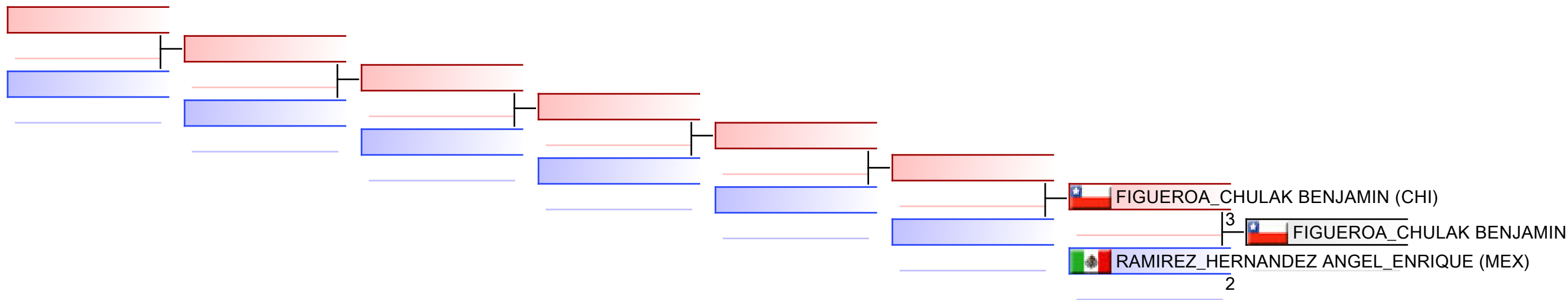

Referees:							
-----------	--	--	--	--	--	--	--



# Junior Kumite Male -61 kg

Karate1 Youth League - Acapulco 2022, Acapulco, MEX

Tatami  
3 09:00

Pool  
1/2

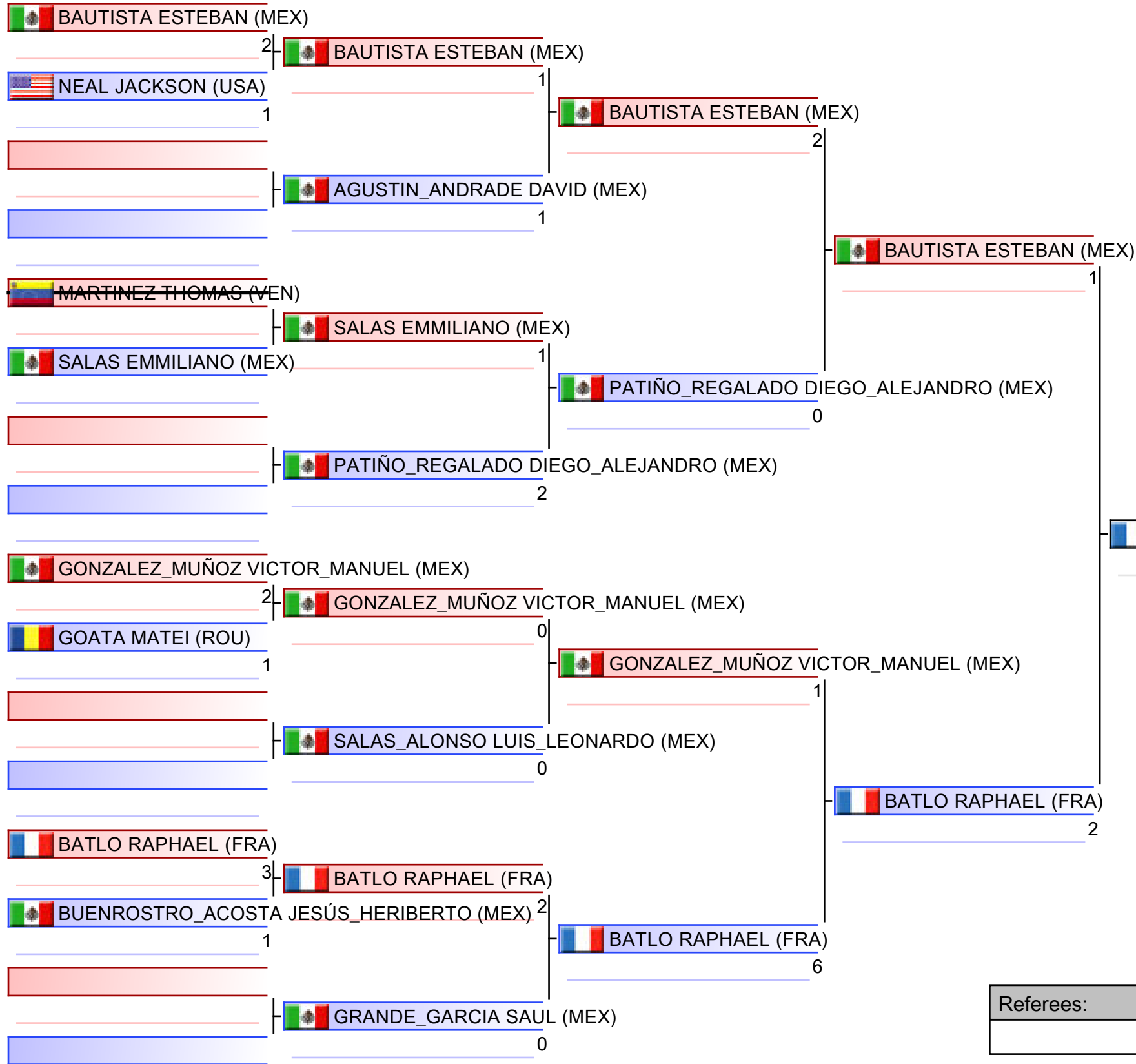

- |  |
|--|
| 1. BATLO RAPHAEL (FRA)                     |
| 2. SOLIS MATEO (USA)                       |
| 3. DORTA JANCO (USA)                       |
| 3. BAUTISTA ESTEBAN (MEX)                  |
| 5. DZIUDA DOMINIK (POL)                    |
| 5. BUENROSTRO_ACOSTA JESÚS_HERIBERTO (MEX) |
| 7. SOLIS_BRAZON JOSE_DAVID (VEN)           |
| 7. GONZALEZ_MUÑOZ VICTOR_MANUEL (MEX)      |

Referees:			

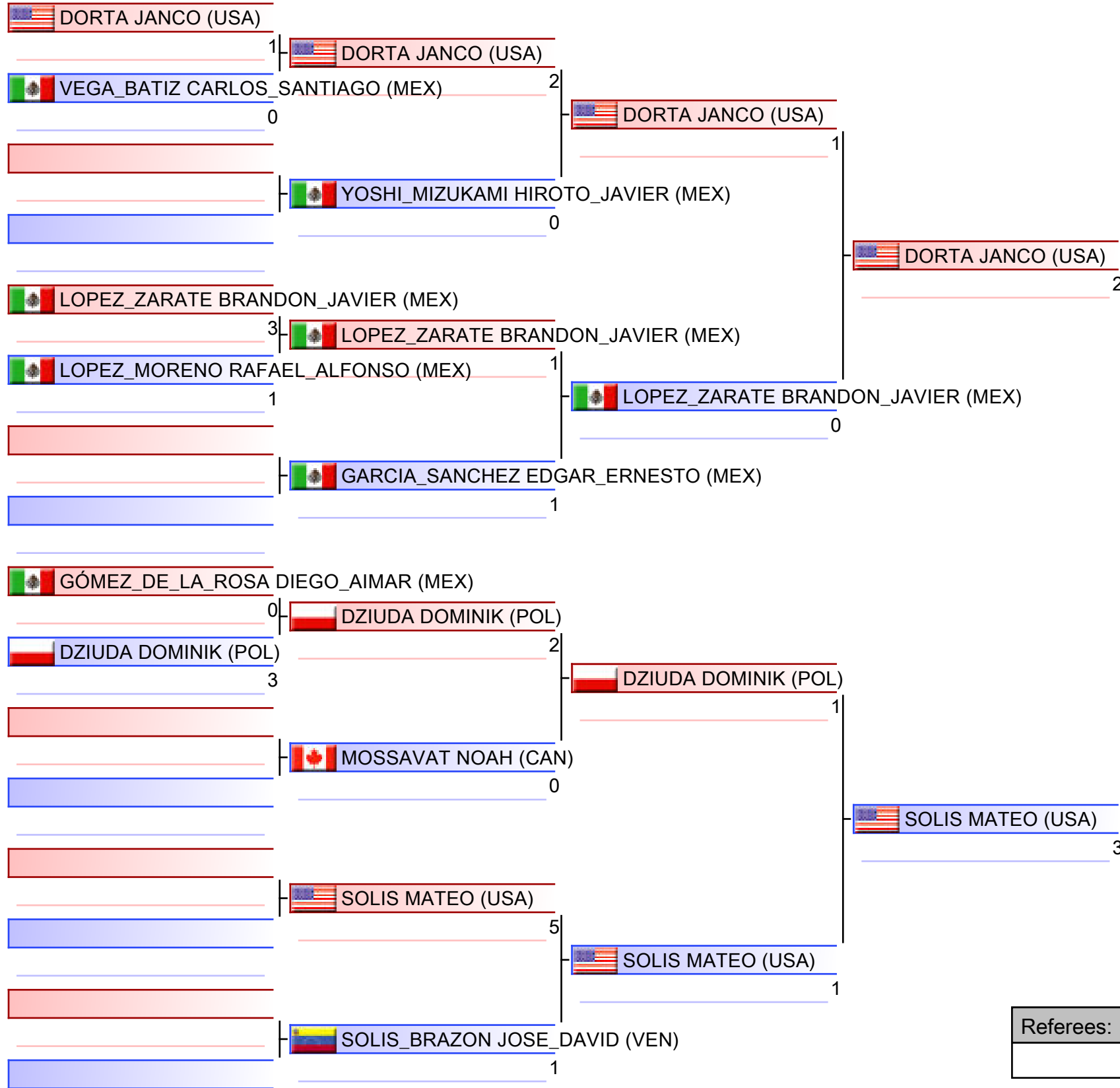

1. BATLO RAPHAEL (FRA)
2. SOLIS MATEO (USA)
3. DORTA JANCO (USA)
3. BAUTISTA ESTEBAN (MEX)
5. DZIUDA DOMINIK (POL)
5. BUENROSTRO_ACOSTA JESÚS_HERIBERTO (MEX)
7. SOLIS_BRAZON JOSE_DAVID (VEN)
7. GONZALEZ_MUÑOZ VICTOR_MANUEL (MEX)

Referees:			

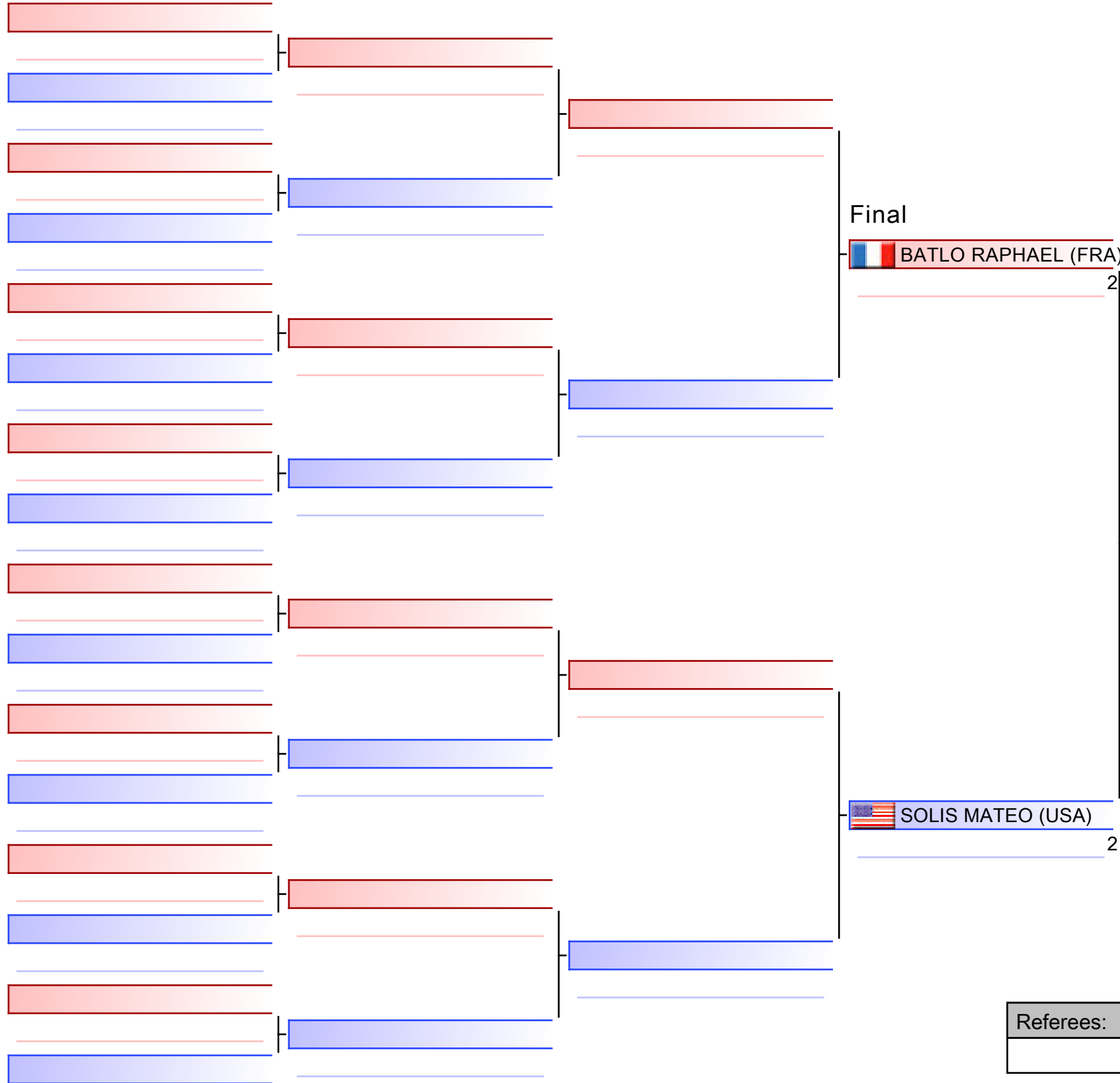

1. BATLO RAPHAEL (FRA)
2. SOLIS MATEO (USA)
3. DORTA JANCO (USA)
3. BAUTISTA ESTEBAN (MEX)
5. DZIUDA DOMINIK (POL)
5. BUENROSTRO_ACOSTA JESÚS_HERIBERTO (MEX)
7. SOLIS_BRAZON JOSE_DAVID (VEN)
7. GONZALEZ_MUÑOZ VICTOR_MANUEL (MEX)

Referees:			

# Junior Kumite Male -61 kg

Karate1 Youth League - Acapulco 2022

Tatami  
3 10:25

Pool  
1,2

(c)sportdata GmbH & Co KG 2000-2022(2022-01-23 12:44) -WKF Approved- v 9.8.8 build 3 (2021-11-04) License: Online\_Event\_ID-560\_Karate1YouthLeagueAcapulco2022 (expire 2022-02-06)

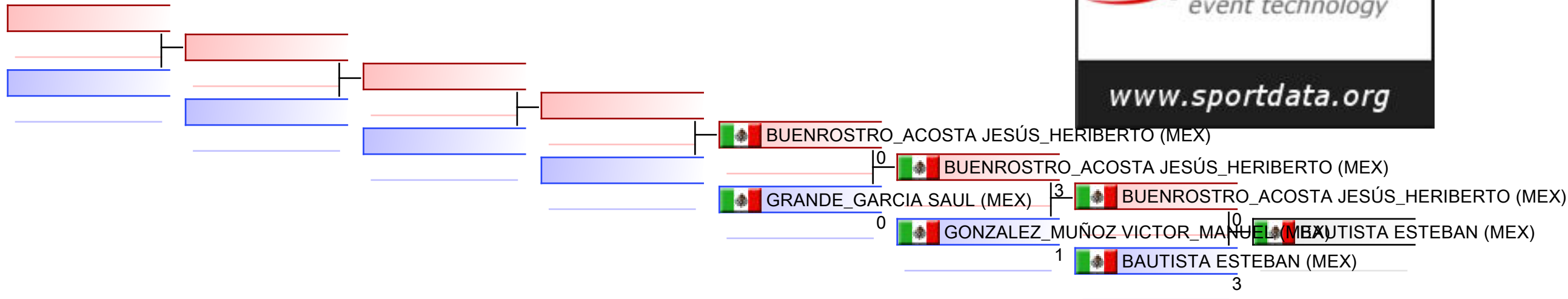

## REPECHAGE: (1,2)

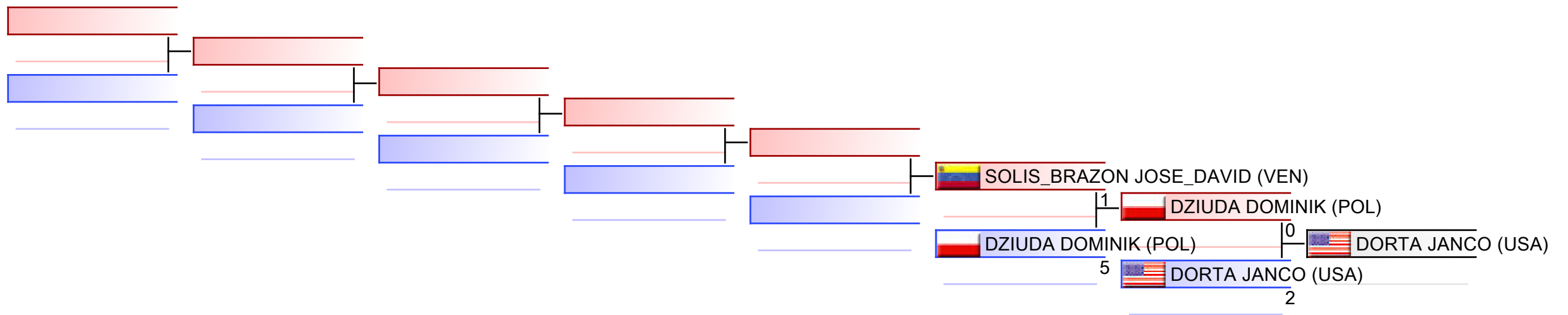

Referees:							
-----------	--	--	--	--	--	--	--

# Junior Kumite Male -68 kg

Karate1 Youth League - Acapulco 2022, Acapulco, MEX

Tatami  
2 14:15

Pool  
1/1

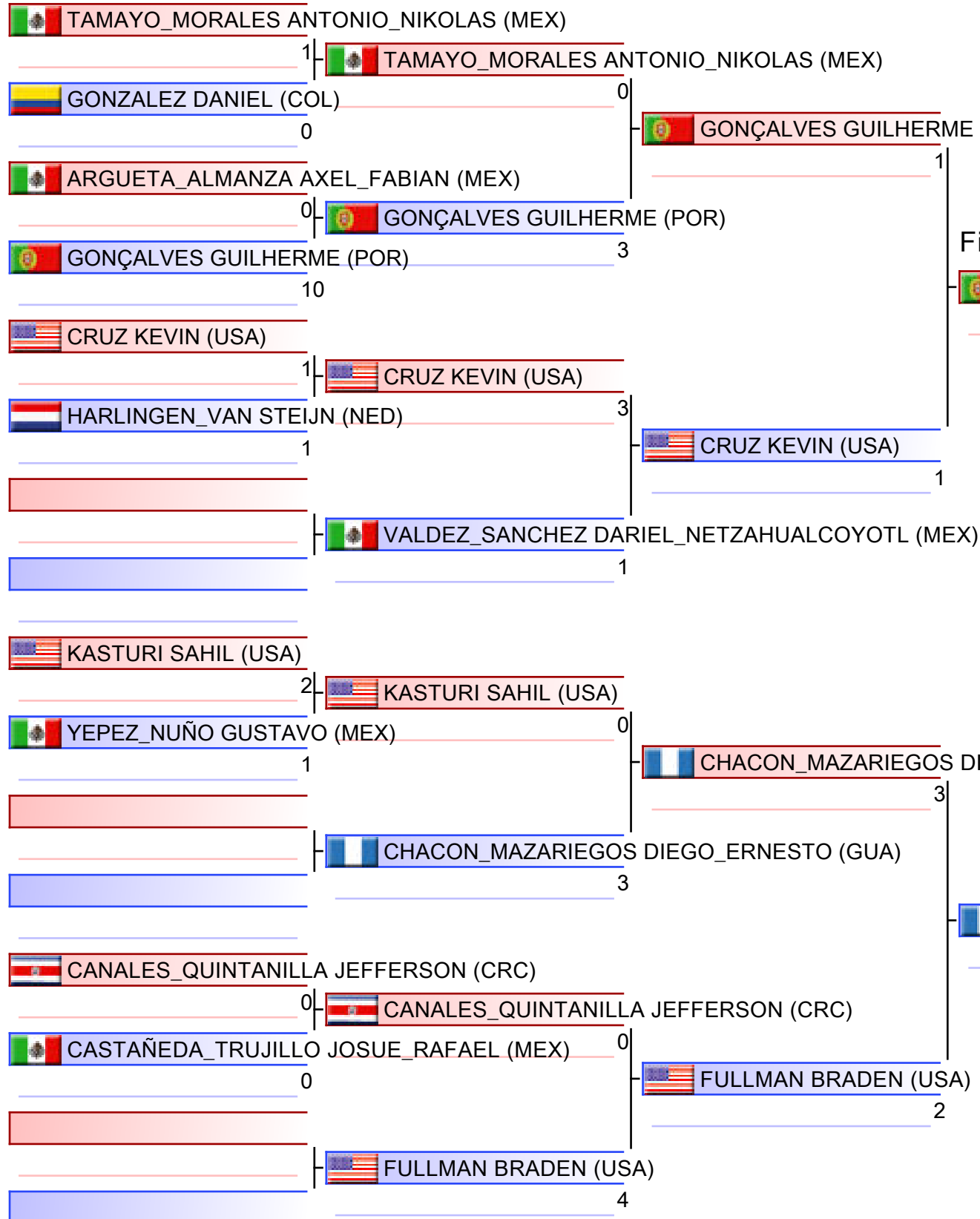

- |  |
|--|
| 1. GONÇALVES GUILHERME (POR)             |
| 2. CHACON_MAZARIEGOS DIEGO_ERNESTO (GUA) |
| 3. KASTURI SAHIL (USA)                   |
| 3. CRUZ KEVIN (USA)                      |
| 5. FULLMAN BRADEN (USA)                  |
| 5. TAMAYO_MORALES ANTONIO_NIKOLAS (MEX)  |
| 7. ARGUETA_ALMANZA AXEL_FABIAN (MEX)     |

Referees:			

# Junior Kumite Male -68 kg

Karate1 Youth League - Acapulco 2022

Tatami  
2 15:00

Pool  
1

(c)sportdata GmbH & Co KG 2000-2022(2022-01-23 12:44) -WKF Approved- v 9.8.8 build 3 (2021-11-04) License: Online\_Event\_ID-560\_Karate1YouthLeagueAcapulco2022 (expire 2022-02-06)

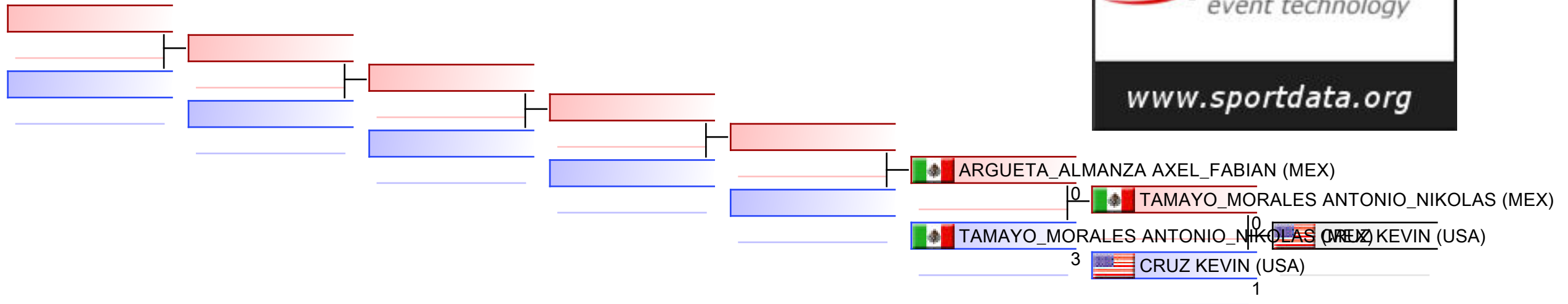

## REPECHAGE: (1)

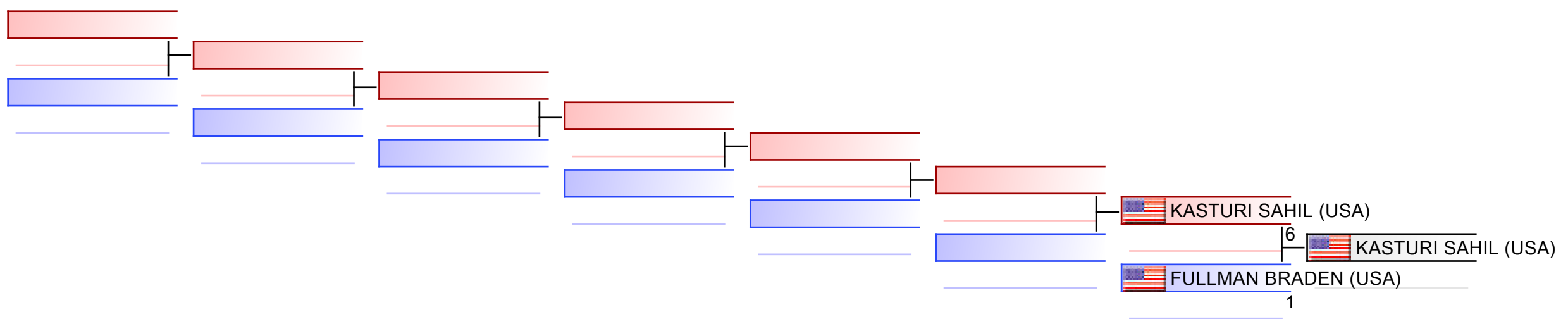

Referees:							
-----------	--	--	--	--	--	--	--

# Junior Kumite Male -76 kg

Karate1 Youth League - Acapulco 2022, Acapulco, MEX

Tatami  
3 14:20

Pool  
1/1

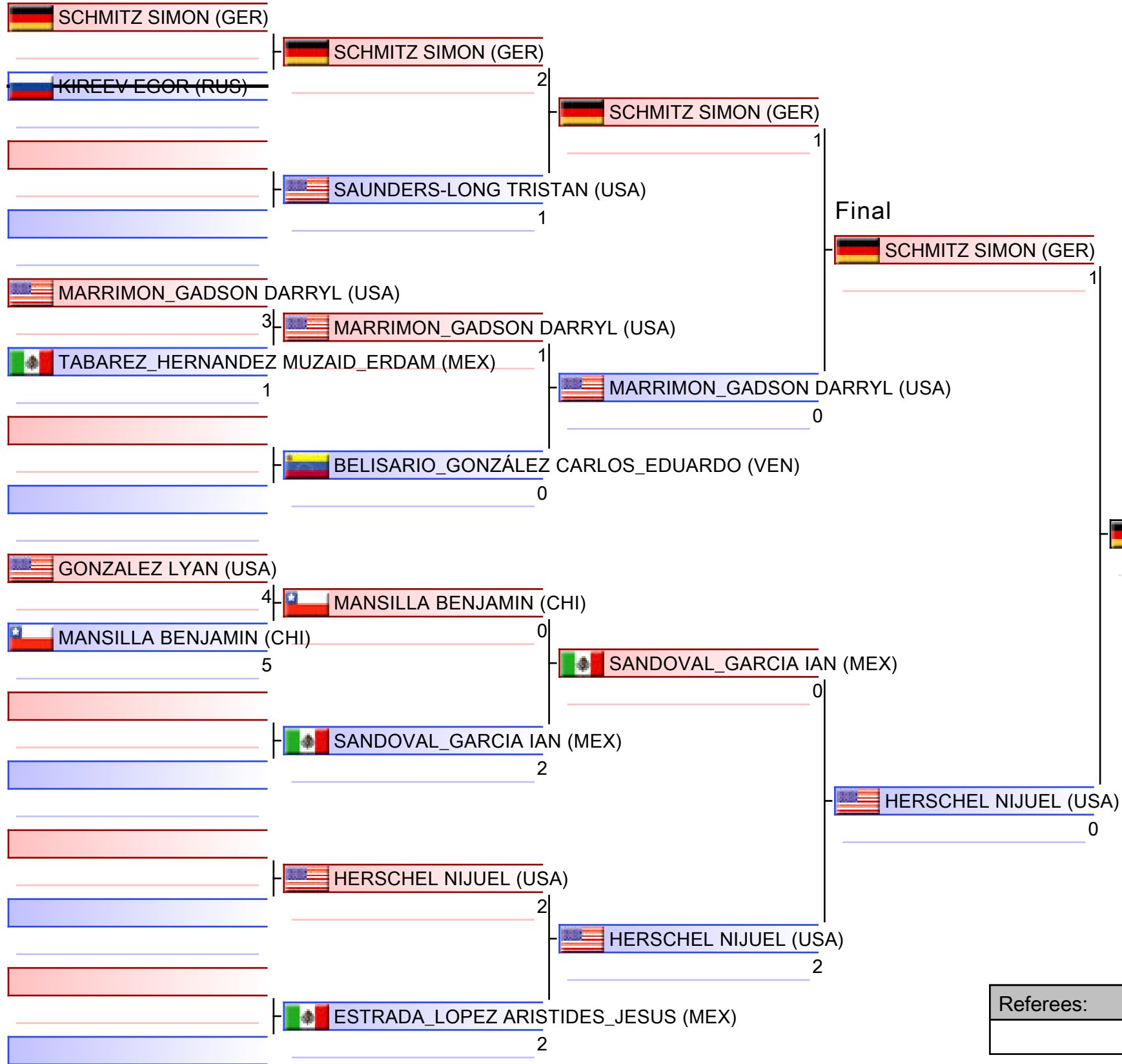

1. SCHMITZ SIMON (GER)
2. HERSCHEL NIJUEL (USA)
3. SAUNDERS-LONG TRISTAN (USA)
3. ESTRADA_LOPEZ ARISTIDES_JESUS (MEX)
5. MARRIMON_GADSON DARRYL (USA)
5. SANDOVAL_GARCIA IAN (MEX)

Referees:			

# Junior Kumite Male -76 kg

Karate1 Youth League - Acapulco 2022

Tatami  
3 14:55

Pool  
1

(c)sportdata GmbH & Co KG 2000-2022(2022-01-23 12:44) -WKF Approved- v 9.8.8 build 3 (2021-11-04) License: Online\_Event\_ID-560\_Karate1YouthLeagueAcapulco2022 (expire 2022-02-06)

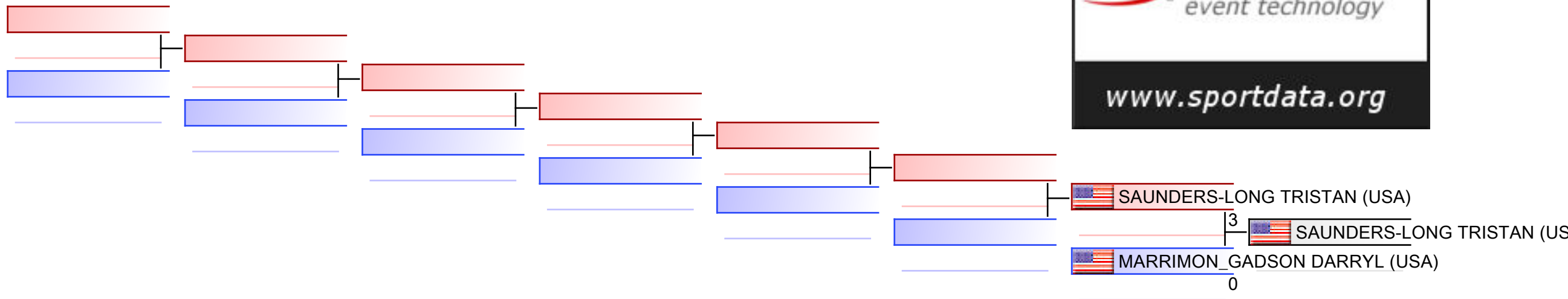

## REPECHAGE: (1)

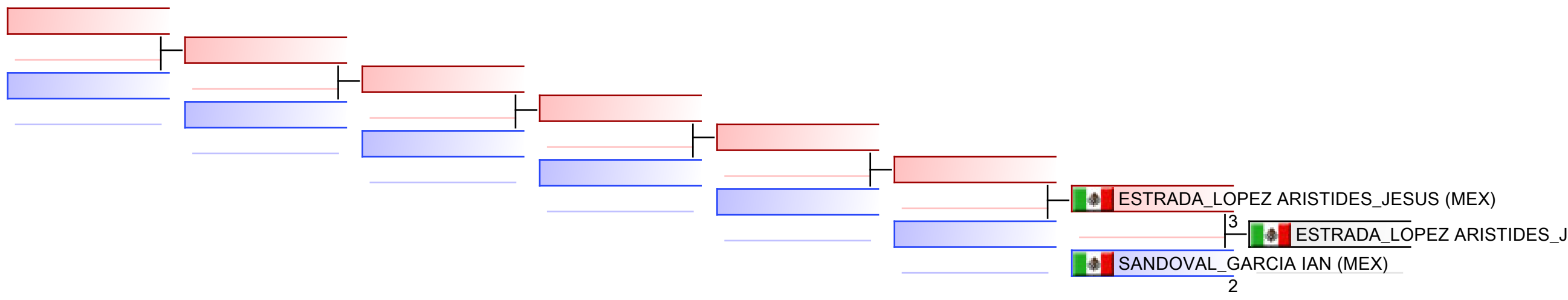

Referees:							
-----------	--	--	--	--	--	--	--



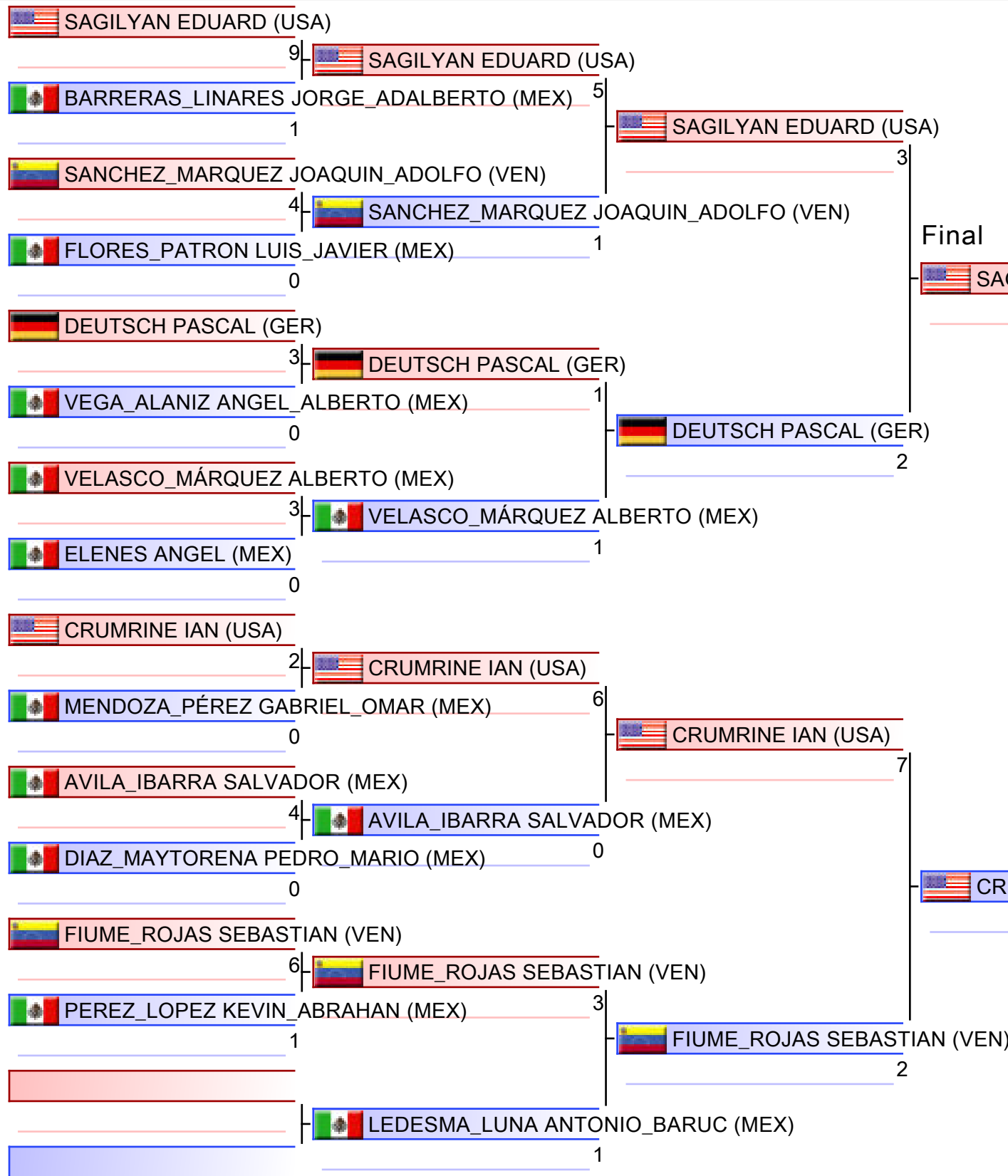

1. SAGILYAN EDUARD (USA)
2. CRUMRINE IAN (USA)
3. FIUME_ROJAS SEBASTIAN (VEN)
3. DEUTSCH PASCAL (GER)
5. SANCHEZ_MARQUEZ JOAQUIN_ADOLFO (VEN)
7. BARRERAS_LINARES JORGE_ADALBERTO (MEX)

Referees:			

# Junior Kumite Male 76+ kg

Karate1 Youth League - Acapulco 2022

Tatami  
1 13:20

Pool  
1

(c)sportdata GmbH & Co KG 2000-2022(2022-01-23 12:44) -WKF Approved- v 9.8.8 build 3 (2021-11-04) License: Online\_Event\_ID-560\_Karate1YouthLeagueAcapulco2022 (expire 2022-02-06)

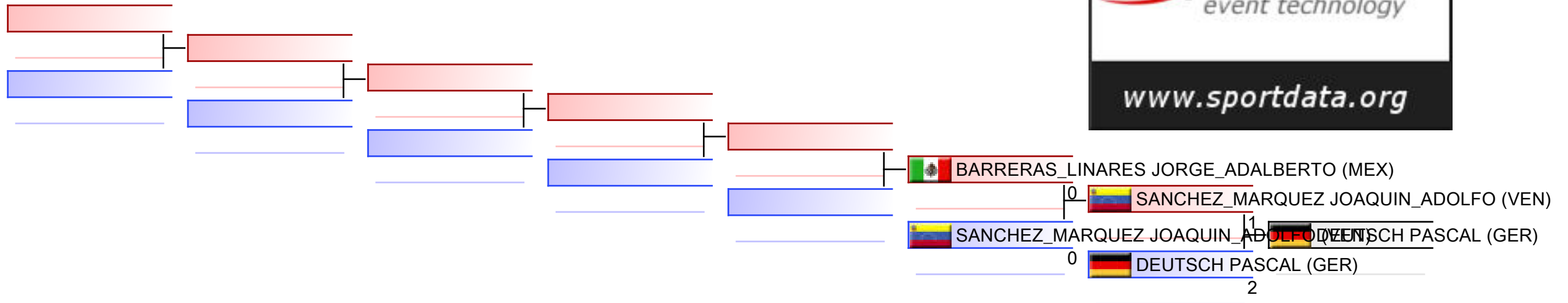

## REPECHAGE: (1)

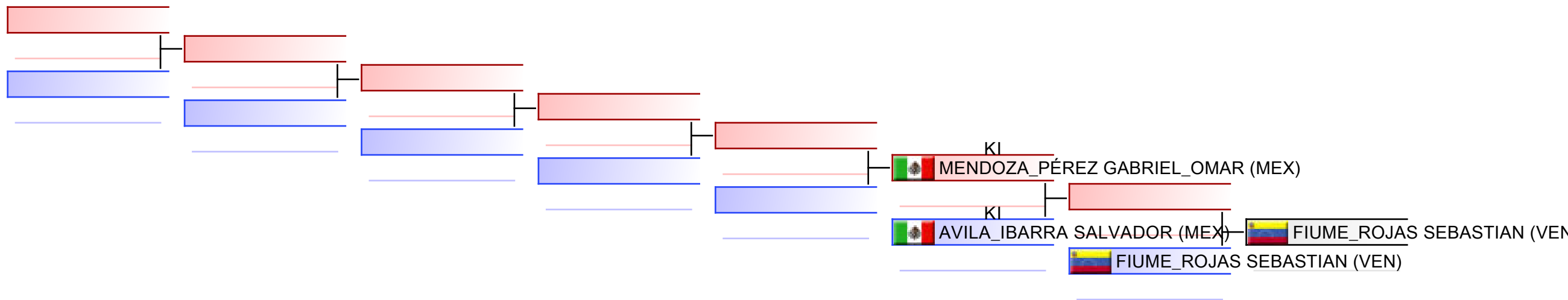

Referees:							
-----------	--	--	--	--	--	--	--



## Karate1 Youth League - Acapulco 2022 - 2022-01-21

### U14 Kata Female

#### R1 G1/2 (6) Tatami 1 09:00

Competitors	Kata	1T	1A	2T	2A	3T	3A	4T	4A	5T	5A	6T	6A	7T	7A	TEC	ATH	Extra	Total Rank
1 FRIAS DESSIRE (PAN)	030 HEIKU	(6.6)	6.8	7.2	7.0	6.8	(6.6)	(7.4)	(7.2)	7.0	6.8					14.7	6.18		20.884
2 TAMAYO_MORALES SENECA (MEX)	068 PAPUREN	6.8	6.8	(6.6)	(6.6)	7.0	6.8	(7.2)	(7.4)	6.8	6.6					14.42	6.06		20.486
3 HERRERA_RODRIGUEZ ANDREA (MEX)	002 ANAN DAI	7.0	6.6	(6.8)	(6.4)	7.2	7.0	(7.4)	(7.4)	6.8	6.8					14.7	6.12		20.825
4 PEREZ ALESSANDRA (USA)	008 CHATANYARA KUSHANKU	(7.8)	(7.6)	7.6	7.4	(6.8)	(7.0)	7.6	7.4	6.8	7.2					15.4	6.6		22.0 1
5 QUINTERO_AVAS YUBIA_MARINA (MEX)	068 PAPUREN	(7.6)	7.2	(6.8)	6.8	6.8	(6.6)	7.4	(7.4)	7.0	6.6					14.84	6.18		21.023
6 LOPEZ_ARCE SASHA (CRC)	092 SUPARINPEI	(7.6)	(7.6)	7.2	(6.8)	(7.0)	7.0	7.4	7.6	7.0	6.8					15.12	6.42		21.542

#### R1 G2/2 (6) Tatami 2 09:00

Competitors	Kata	1T	1A	2T	2A	3T	3A	4T	4A	5T	5A	6T	6A	7T	7A	TEC	ATH	Extra	Total Rank
1 ONTIVEROS DURAN ANDREA ISABELLA (MEX)	009 CHIBANA NO KUSHANKU	(6.8)	(6.6)	(5.6)	(5.8)	6.0	6.0	6.6	6.4	6.8	6.6					13.58	5.7		19.285
2 CHU SIENNA MIYU (USA)	002 ANAN DAI	7.2	7.4	7.4	7.2	7.8	7.8	(6.8)	(6.8)	(8.2)	(8.2)					15.68	6.72		22.4 3
3 SERRANO_AGUILAR VALERIA_ (ESA)	001 ANAN	(7.0)	6.8	7.0	(7.2)	7.2	7.2	7.0	(6.6)	(7.4)	7.2					14.84	6.36		21.2 4
4 CORRALES VEGA MARIANA GUADALUPE (MEX)																			
5 DEODHARI SIERRA (USA)	001 ANAN	7.6	7.6	(7.8)	7.8	7.6	(8.0)	(7.4)	(7.0)	7.8	7.8					16.1	6.96		23.061
6 FERREIRA_VIELMA STEPHANY VALENTINA (VEN)	068 PAPUREN	7.4	(7.2)	(8.2)	(8.0)	7.6	7.8	(7.2)	7.2	8.0	8.0					16.1	6.9		23.0 2

#### R2-G1

Competitors	Kata	1T	1A	2T	2A	3T	3A	4T	4A	5T	5A	6T	6A	7T	7A	TEC	ATH	Extra	Total Rank
1 FRIAS DESSIRE (PAN)	067 PAIKU	(7.4)	7.2	7.0	6.8	(6.8)	(6.6)	7.4	(7.6)	7.2	6.8					15.12	6.24		21.363
2 LOPEZ_ARCE SASHA (CRC)	021 GOJUSHIHO SHO	(7.6)	7.2	(7.2)	(7.0)	7.2	7.0	7.4	(7.4)	7.2	7.2					15.26	6.42		21.682
3 PEREZ ALESSANDRA (USA)	092 SUPARINPEI	(7.8)	(7.8)	7.4	7.4	(7.2)	(7.2)	7.6	7.4	7.4	7.2					15.68	6.6		22.281
4 QUINTERO_AVAS YUBIA_MARINA (MEX)	008 CHATANYARA KUSHANKU	(6.4)	(6.4)	6.8	6.6	6.6	6.6	(7.2)	(7.2)	7.0	7.0					14.28	6.06		20.344

#### R2-G2

Competitors	Kata	1T	1A	2T	2A	3T	3A	4T	4A	5T	5A	6T	6A	7T	7A	TEC	ATH	Extra	Total Rank
1 FERREIRA_VIELMA STEPHANY VALENTINA (VEN)	002 ANAN DAI	(8.4)	(8.2)	(7.4)	(7.6)	7.8	7.6	8.0	8.0	7.8	7.8					16.52	7.02		23.543
2 SERRANO_AGUILAR VALERIA_ (ESA)	067 PAIKU	(6.2)	(6.0)	7.2	7.0	7.2	7.0	(7.8)	(7.8)	7.4	7.4					15.26	6.42		21.684
3 DEODHARI SIERRA (USA)	009 CHIBANA NO KUSHANKU	7.8	8.0	7.8	7.8	(7.6)	(7.4)	(8.0)	8.0	8.0	(8.2)					16.52	7.14		23.662
4 CHU SIENNA MIYU (USA)	068 PAPUREN	(7.4)	7.6	8.0	7.8	7.4	(7.0)	(8.4)	(8.4)	8.4	8.2					16.66	7.08		23.741

#### R3 Bronze Medal Match 1

Competitors	Kata	1T	1A	2T	2A	3T	3A	4T	4A	5T	5A	6T	6A	7T	7A	TEC	ATH	Extra	Total Rank
1 LOPEZ_ARCE SASHA (CRC)	020 GOJUSHIHO DAI	7.2	7.0	(7.6)	(7.4)	(7.0)	(6.8)	7.0	7.2	7.6	7.4					15.26	6.48		21.742
2 FERREIRA_VIELMA STEPHANY VALENTINA (VEN)	064 OHAN DAI	7.4	(7.2)	(8.0)	(8.0)	(7.2)	7.2	7.8	7.6	8.0	8.0					16.24	6.84		23.081

#### R3 Bronze Medal Match 2

Competitors	Kata	1T	1A	2T	2A	3T	3A	4T	4A	5T	5A	6T	6A	7T	7A	TEC	ATH	Extra	Total Rank
1 FRIAS DESSIRE (PAN)	046 KOUSOUKUN SHO	(5.0)	(5.0)	(7.4)	(7.0)	5.8	5.8	7.2	7.0	5.6	5.6					13.02	5.52		18.542
2 DEODHARI SIERRA (USA)	002 ANAN DAI	7.8	7.8	7.8	7.6	(7.4)	(7.2)	(8.0)	7.8	8.0	(8.0)					16.52	6.96		23.481

#### R3 Gold Medal Match

Competitors	Kata	1T	1A	2T	2A	3T	3A	4T	4A	5T	5A	6T	6A	7T	7A	TEC	ATH	Extra	Total Rank
1 PEREZ ALESSANDRA (USA)	009 CHIBANA NO KUSHANKU	7.6	7.6	(7.4)	(7.2)	(8.2)	(8.4)	7.8	7.6	7.8	7.8					16.24	6.9		23.141
2 CHU SIENNA MIYU (USA)	008 CHATANYARA KUSHANKU	7.4	7.6	(7.2)	(7.0)	(8.4)	(8.6)	7.6	7.8	7.8	8.0					15.96	7.02		22.982

#### Results

1	PEREZ ALESSANDRA		UNITED STATES
2	CHU SIENNA MIYU		UNITED STATES
3	FERREIRA_VIELMA STEPHANY VALENTINA		VENEZUELA
3	DEODHARI SIERRA		UNITED STATES



Karate1 Youth League - Acapulco 2022 - 2022-01-21  
U14 Kata Male

R1 G1/2 (8) Tatami 1 10:00

Competitors	Kata	1T	1A	2T	2A	3T	3A	4T	4A	5T	5A	6T	6A	7T	7A	TEC	ATH	Extra	Total	Rank	
1 VIERA_HERNANDEZ EMMANUEL (MEX)	064 OHAN DAI																				
2 HO DAVID (USA)	002 ANAN DAI	(7.6)	(7.4)	(6.6)	(6.8)	7.2	7.2	7.4	7.2	7.4	7.4					15.4	6.54		21.944		
3 MATSUMOTO ERIC (USA)	002 ANAN DAI	(7.6)	(7.8)	(6.8)	(6.6)	7.4	7.4	7.6	7.4	7.4	7.6					15.68	6.72		22.4	3	
4 DELGADO_SANCHEZ ALFONSO ANDRE (MEX)	008 CHATANYARA KUSHANKU	6.6	6.6	(6.2)	(6.2)	6.8	6.8	(7.2)	(7.0)	6.8	6.4					14.14	5.94		20.086		
5 BALDERRAMA_PALACIOS ENRIQUE_ALEJANDRO (MEX)	009 CHIBANA NO KUSHANKU	6.8	(6.8)	(6.2)	(6.2)	6.6	6.6	(7.0)	6.8	6.2	6.2					13.72	5.88		19.6	7	
6 ISA CHEON (USA)	068 PAPUREN	(8.2)	(8.2)	(7.4)	7.6	7.4	(7.4)	7.6	7.4	7.6	7.6					15.82	6.78		22.6	2	
7 GONZALEZ KARIM_OZIEL (MEX)	064 OHAN DAI	7.2	7.0	7.2	(7.4)	(6.8)	(6.8)	(7.4)	7.2	7.4	7.2					15.26	6.42		21.68	5	
8 GRECO GIANLUCA (VEN)	008 CHATANYARA KUSHANKU	(7.8)	(8.0)	(7.4)	7.6	7.4	(7.2)	7.6	7.4	7.8	7.6					15.96	6.78		22.74	1	

R1 G2/2 (8) Tatami 2 10:00

Competitors	Kata	1T	1A	2T	2A	3T	3A	4T	4A	5T	5A	6T	6A	7T	7A	TEC	ATH	Extra	Total	Rank
1 HO DANIEL (USA)	002 ANAN DAI	7.6	7.6	(7.4)	7.6	(7.8)	7.6	7.8	(7.8)	7.4	(7.4)					15.96	6.84		22.8	4
2 HONORATO_ARRIAGA DANTE_ZAHIR (MEX)	092 SUPARINPEI	7.0	7.0	6.8	6.8	(7.4)	(7.2)	(6.2)	(6.0)	6.8	6.8					14.42	6.18		20.6	6
3 CHOJNACKI BARTOSZ (POL)	021 GOJUSHIHO SHO	(8.0)	(8.0)	7.6	7.6	7.6	(7.4)	(7.4)	7.6	7.6	7.6					15.96	6.84		22.8	3
4 SAGILYAN MIKHAIL (USA)	041 KANKU SHO	7.0	7.0	(6.6)	(6.8)	7.2	7.0	(7.6)	(7.8)	6.8	7.0					14.7	6.3		21.0	5
5 RODRIGUEZ LUIS (MEX)	001 ANAN	(8.2)	(8.2)	7.6	7.8	(7.0)	(7.0)	7.8	7.8	7.6	7.4					16.1	6.9		23.0	2
6 FARRIS LOGAN (USA)	012 ENPI	(7.2)	(7.4)	(5.8)	(5.8)	6.0	6.0	6.0	6.0	6.6	6.4					13.02	5.52		18.54	7
7 GALMICHE ANGEL_YERIK (MEX)	064 OHAN DAI	8.0	(8.2)	7.8	(7.6)	(8.2)	8.2	8.0	7.8	(7.6)	7.6					16.66	7.08		23.74	1
8 CASTILLO CESAR (USA)																				

R2-G1

Competitors	Kata	1T	1A	2T	2A	3T	3A	4T	4A	5T	5A	6T	6A	7T	7A	TEC	ATH	Extra	Total	Rank
1 HO DAVID (USA)	008 CHATANYARA KUSHANKU	7.2	7.2	(6.8)	(6.6)	7.0	7.0	7.4	7.4	(7.6)	(7.8)					15.12	6.48		21.6	4
2 ISA CHEON (USA)	009 CHIBANA NO KUSHANKU	(7.8)	(7.6)	7.4	7.4	(7.2)	(7.2)	7.6	7.4	7.8	7.6					15.96	6.72		22.68	2
3 MATSUMOTO ERIC (USA)	068 PAPUREN	(7.6)	(7.8)	(7.2)	(6.8)	7.4	7.4	7.6	7.6	7.6	7.8					15.82	6.84		22.66	3
4 GRECO GIANLUCA (VEN)	068 PAPUREN	(8.0)	(8.0)	7.4	7.6	(7.2)	(7.0)	7.6	7.8	7.8	7.8					15.96	6.96		22.92	1

R2-G2

Competitors	Kata	1T	1A	2T	2A	3T	3A	4T	4A	5T	5A	6T	6A	7T	7A	TEC	ATH	Extra	Total	Rank
1 CHOJNACKI BARTOSZ (POL)	099 UNSU	(6.8)	(7.0)	(8.0)	(7.8)	7.6	7.8	7.0	7.2	7.8	7.8					15.68	6.84		22.52	4
2 RODRIGUEZ LUIS (MEX)	002 ANAN DAI	(7.4)	(7.2)	8.2	8.0	7.8	8.0	7.6	7.4	(8.4)	(8.2)					16.52	7.02		23.54	3
3 GALMICHE ANGEL_YERIK (MEX)	068 PAPUREN	(7.2)	(7.4)	8.4	8.4	8.0	8.0	7.8	7.6	(8.6)	(8.6)					16.94	7.2		24.14	1
4 HO DANIEL (USA)	068 PAPUREN	(7.4)	(7.2)	8.2	8.0	8.2	7.8	7.6	7.4	(8.4)	(8.2)					16.8	6.96		23.76	2

R3 Bronze Medal Match 1

Competitors	Kata	1T	1A	2T	2A	3T	3A	4T	4A	5T	5A	6T	6A	7T	7A	TEC	ATH	Extra	Total	Rank
1 ISA CHEON (USA)	092 SUPARINPEI	(6.8)	(6.8)	7.6	(7.6)	7.4	7.4	7.6	7.4	(7.8)	7.6					15.82	6.72		22.54	1
2 RODRIGUEZ LUIS (MEX)	068 PAPUREN	(6.4)	(6.4)	7.4	(7.4)	7.0	6.8	(7.6)	7.2	7.4	7.4					15.26	6.42		21.68	2

R3 Bronze Medal Match 2

Competitors	Kata	1T	1A	2T	2A	3T	3A	4T	4A	5T	5A	6T	6A	7T	7A	TEC	ATH	Extra	Total	Rank
1 MATSUMOTO ERIC (USA)	092 SUPARINPEI	8.0	(8.2)	(7.6)	(7.6)	(8.2)	8.0	8.2	8.0	7.8	7.8					16.8	7.14		23.94	2
2 HO DANIEL (USA)	009 CHIBANA NO KUSHANKU	8.0	8.0	8.0	8.0	(8.4)	(8.4)	8.4	8.4	(7.4)	(7.2)					17.08	7.32		24.4	1

R3 Gold Medal Match

Competitors	Kata	1T	1A	2T	2A	3T	3A	4T	4A	5T	5A	6T	6A	7T	7A	TEC	ATH	Extra	Total	Rank
1 GRECO GIANLUCA (VEN)	043 KISHIMOTO NO KUSHANKU	(7.8)	(7.8)	8.4	8.6	8.4	8.6	8.2	8.4	(8.6)	(8.8)					17.5	7.68		25.18	1
2 GALMICHE ANGEL_YERIK (MEX)	008 CHATANYARA KUSHANKU	(7.2)	(7.2)	(8.6)	(8.4)	8.0	8.0	7.8	8.0	8.2	8.2					16.8	7.26		24.06	2

Results

1	GRECO GIANLUCA		VENEZUELA
2	GALMICHE ANGEL YERIK		MEXICO
3	ISA CHEON		UNITED STATES
3	HO DANIEL		UNITED STATES

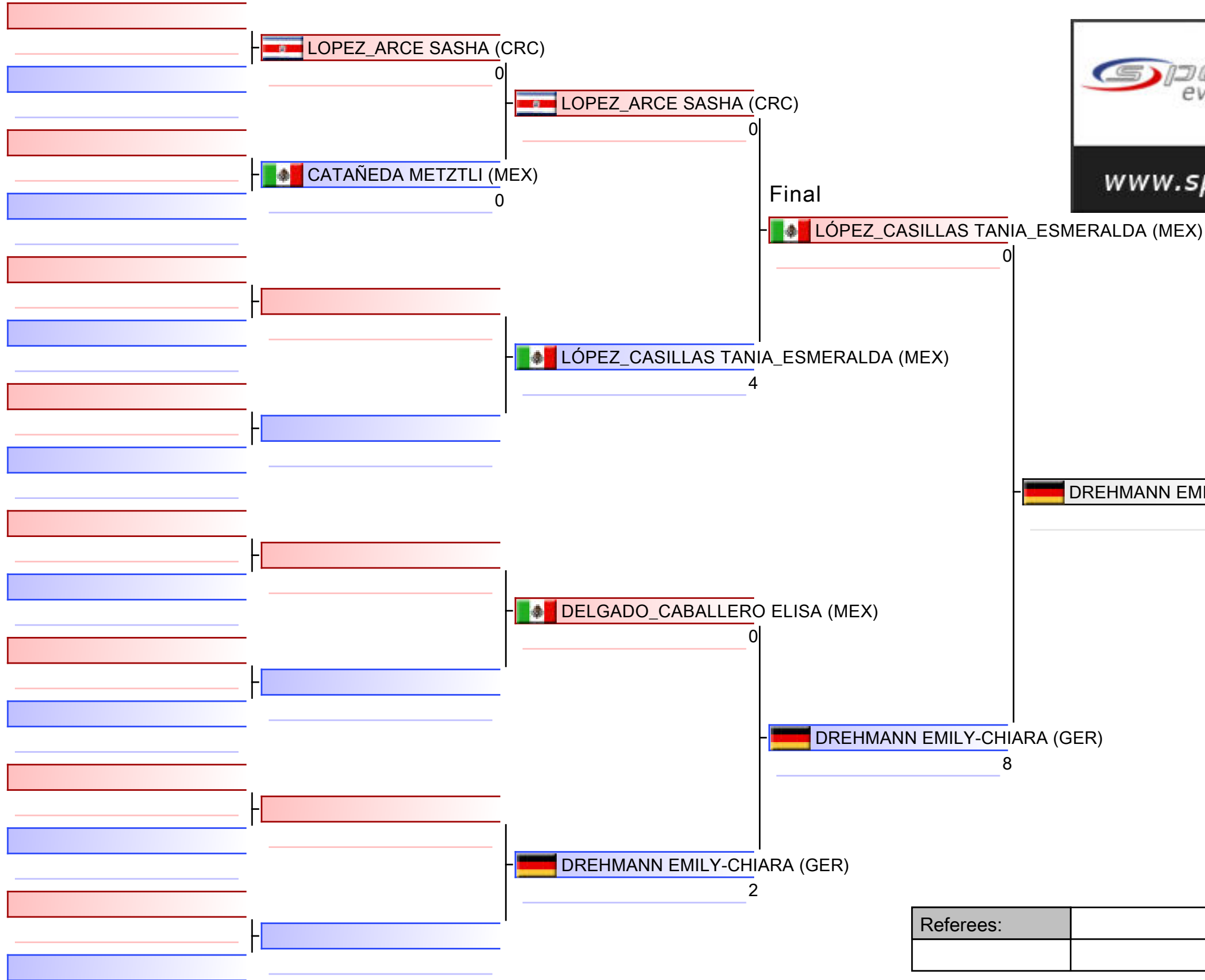

1. DREHMANN EMILY-CHIARA (GER)
2. LÓPEZ_CASILLAS TANIA_ESMERALDA (MEX)
3. LOPEZ_ARCE SASHA (CRC)
3. DELGADO_CABALLERO ELISA (MEX)

Referees:			

# U14 Kumite Female -42 kg

Karate1 Youth League - Acapulco 2022

Tatami  
2 12:10

Pool  
1

(c)sportdata GmbH & Co KG 2000-2022(2022-01-23 12:44) -WKF Approved- v 9.8.8 build 3 (2021-11-04) License: Online\_Event\_ID-560\_Karate1YouthLeagueAcapulco2022 (expire 2022-02-06)

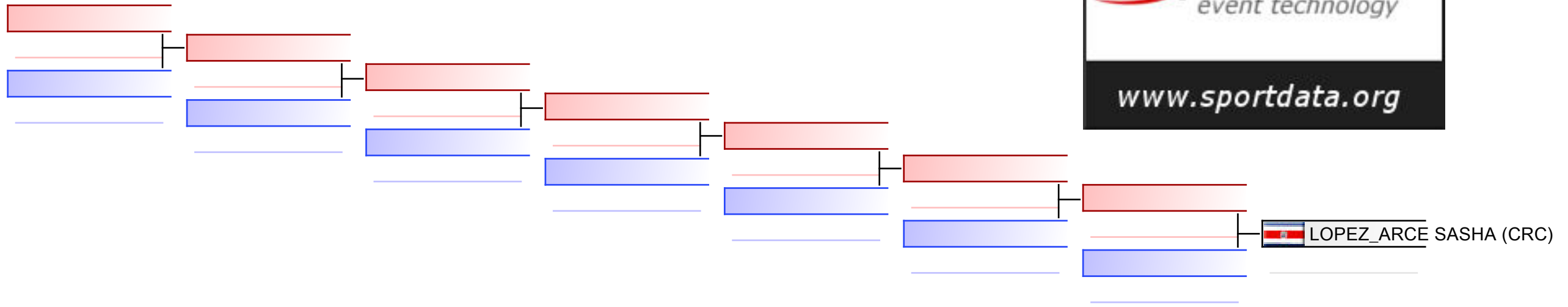

## REPECHAGE: (1)

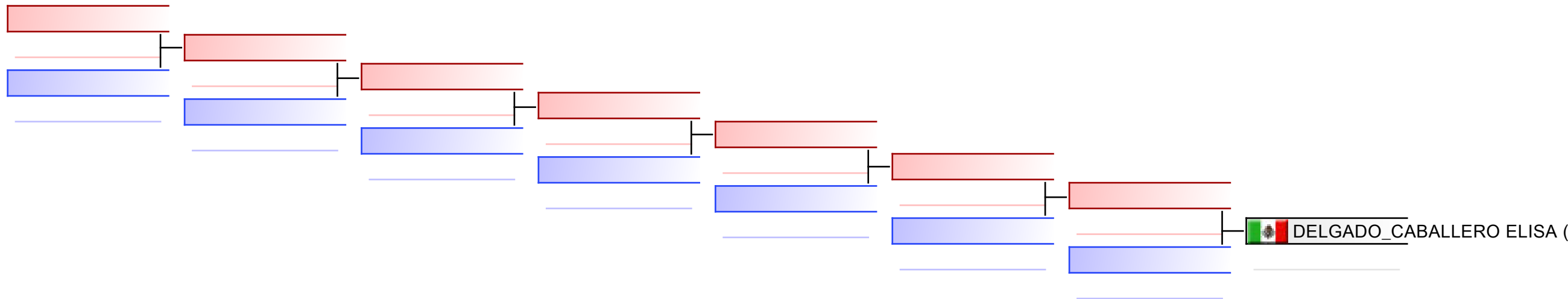

Referees:							
-----------	--	--	--	--	--	--	--

# U14 Kumite Female -47 kg

Karate1 Youth League - Acapulco 2022, Acapulco, MEX

Tatami  
1 11:20

Pool  
1/1

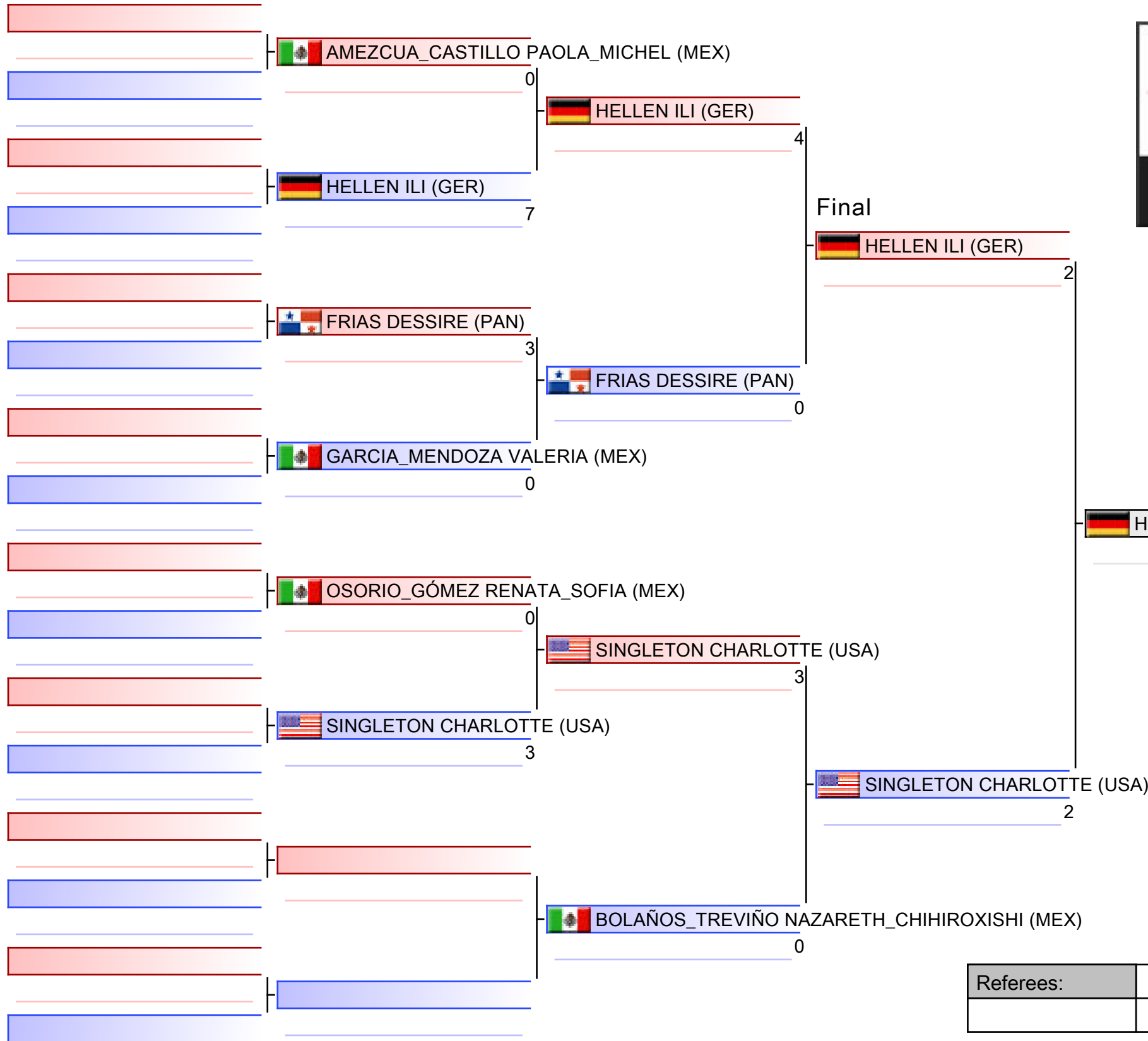

1. HELEN ILI (GER)
2. SINGLETON CHARLOTTE (USA)
3. FRIAS DESSIRE (PAN)
3. BOLAÑOS_TREVIÑO NAZARETH_CHIHIROXISHI (MEX)
5. AMEZCUA_CASTILLO PAOLA_MICHEL (MEX)
5. OSORIO_GÓMEZ RENATA_SOFIA (MEX)

Referees:			

# U14 Kumite Female -47 kg

Karate1 Youth League - Acapulco 2022

Tatami  
1 11:40

Pool  
1

(c)sportdata GmbH & Co KG 2000-2022(2022-01-23 12:44) -WKF Approved- v 9.8.8 build 3 (2021-11-04) License: Online\_Event\_ID-560\_Karate1YouthLeagueAcapulco2022 (expire 2022-02-06)

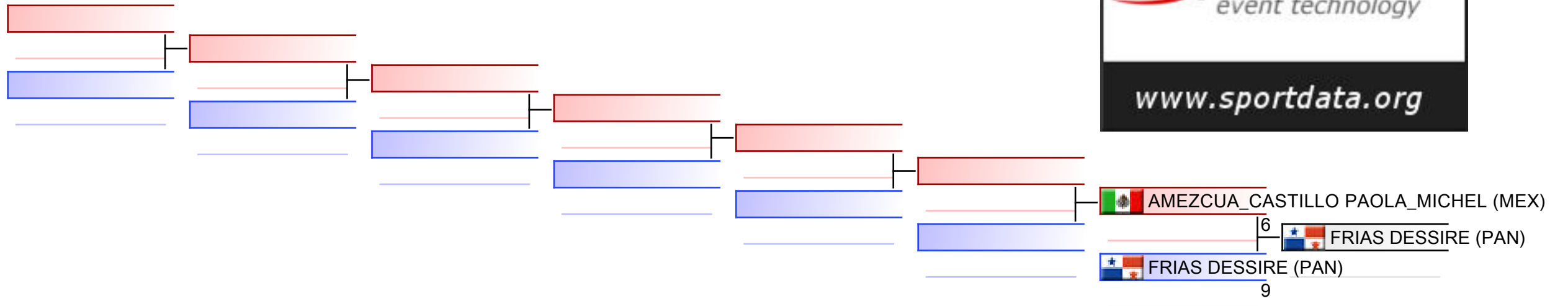

## REPECHAGE: (1)

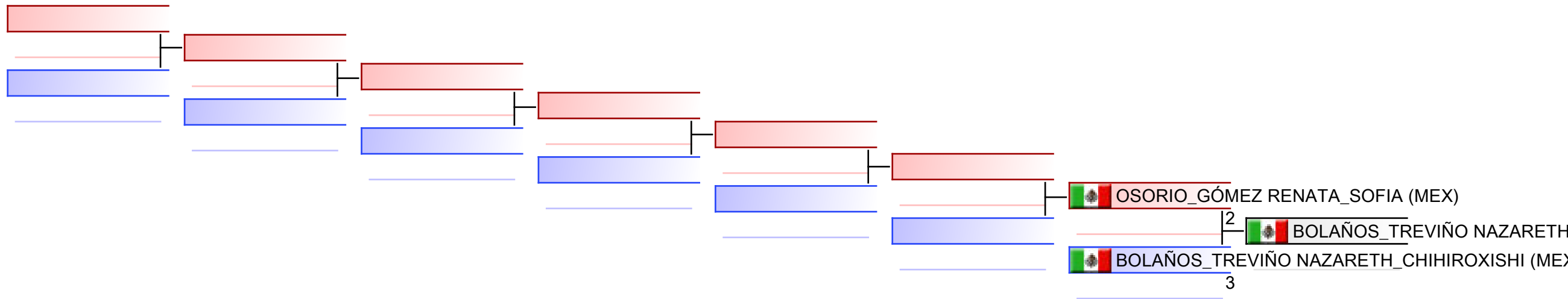

Referees:							
-----------	--	--	--	--	--	--	--



# U14 Kumite Female 47+ kg

Karate1 Youth League - Acapulco 2022, Acapulco, MEX

Tatami  
3 09:45

Pool  
1/1

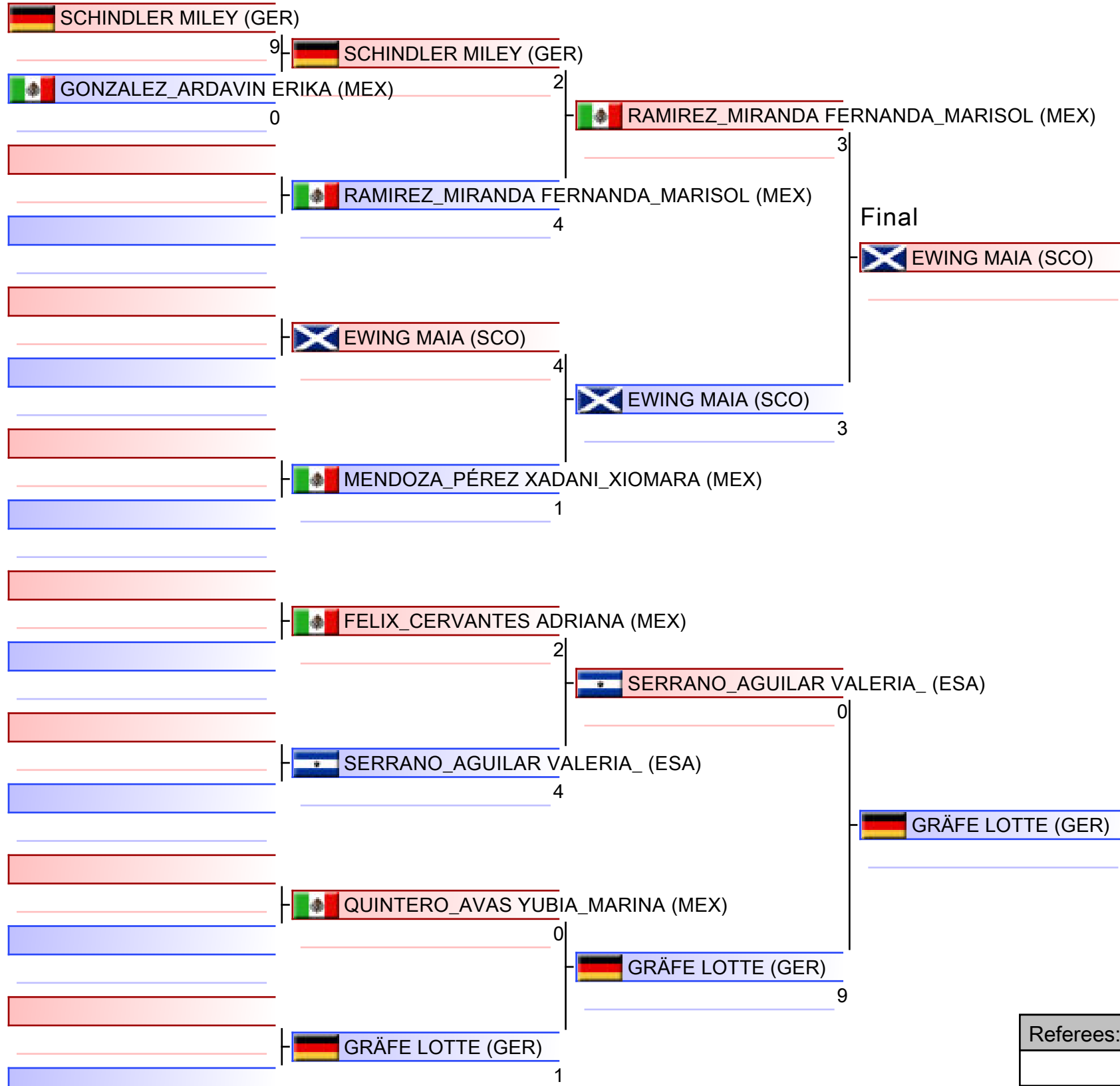

1. EWING MAIA (SCO)
2. GRÄFE LOTTE (GER)
3. RAMIREZ_MIRANDA FERNANDA_MARISOL (MEX)
3. SERRANO_AGUILAR VALERIA_ (ESA)
5. MENDOZA_PÉREZ XADANI_XIOMARA (MEX)
5. QUINTERO_AVAS YUBIA_MARINA (MEX)

Referees:			

# U14 Kumite Female 47+ kg

Karate1 Youth League - Acapulco 2022

Tatami  
3 10:15

Pool  
1

(c)sportdata GmbH & Co KG 2000-2022(2022-01-23 12:44) -WKF Approved- v 9.8.8 build 3 (2021-11-04) License: Online\_Event\_ID-560\_Karate1YouthLeagueAcapulco2022 (expire 2022-02-06)

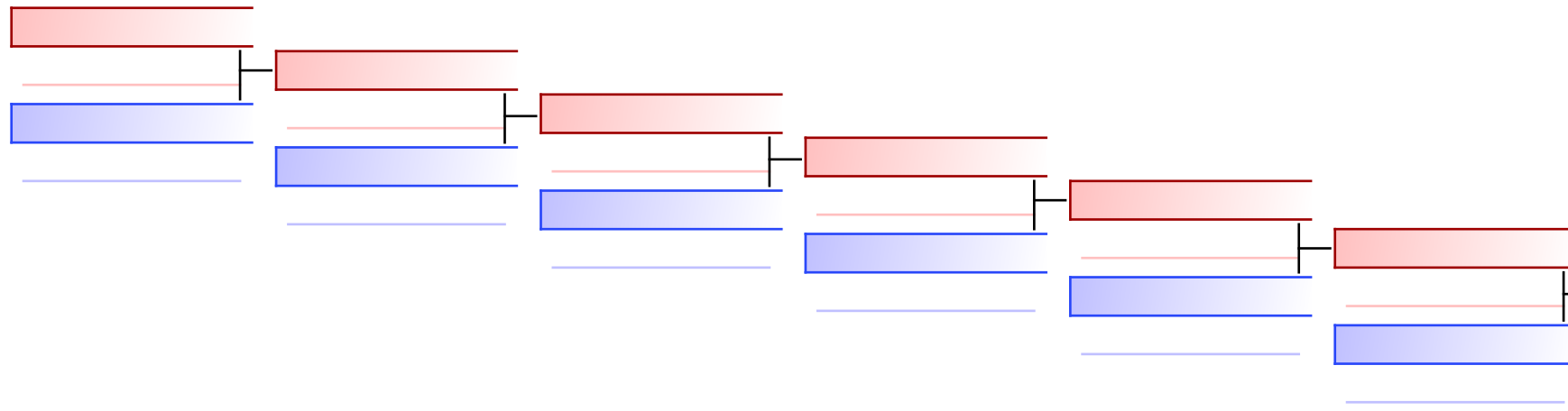

MENDOZA\_PÉREZ XADANI\_XIOMARA (MEX) 0  
RAMIREZ\_MIRANDA FERNANDA  
RAMIREZ\_MIRANDA FERNANDA\_MARISOL (MEX) 6

## REPECHAGE: (1)

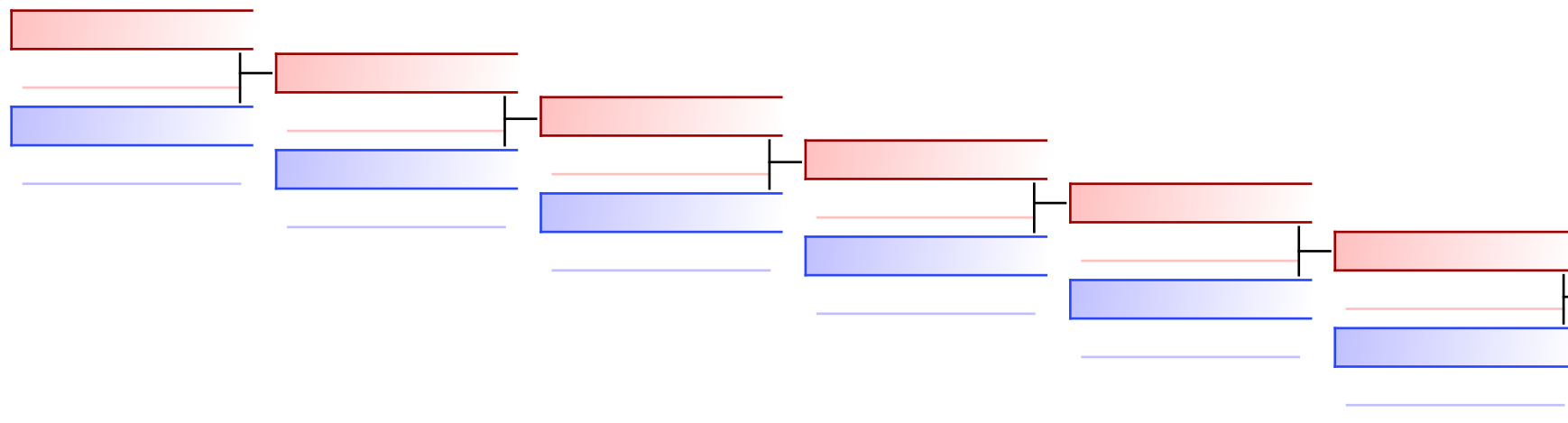

QUINTERO\_AVAS YUBIA\_MARINA (MEX) 2  
SERRANO\_AGUILAR VALERIA\_  
SERRANO\_AGUILAR VALERIA\_(ESA) 4

Referees:							
-----------	--	--	--	--	--	--	--

# U14 Kumite Male +55 kg

Karate1 Youth League - Acapulco 2022, Acapulco, MEX

Tatami  
2 11:20

Pool  
1/1

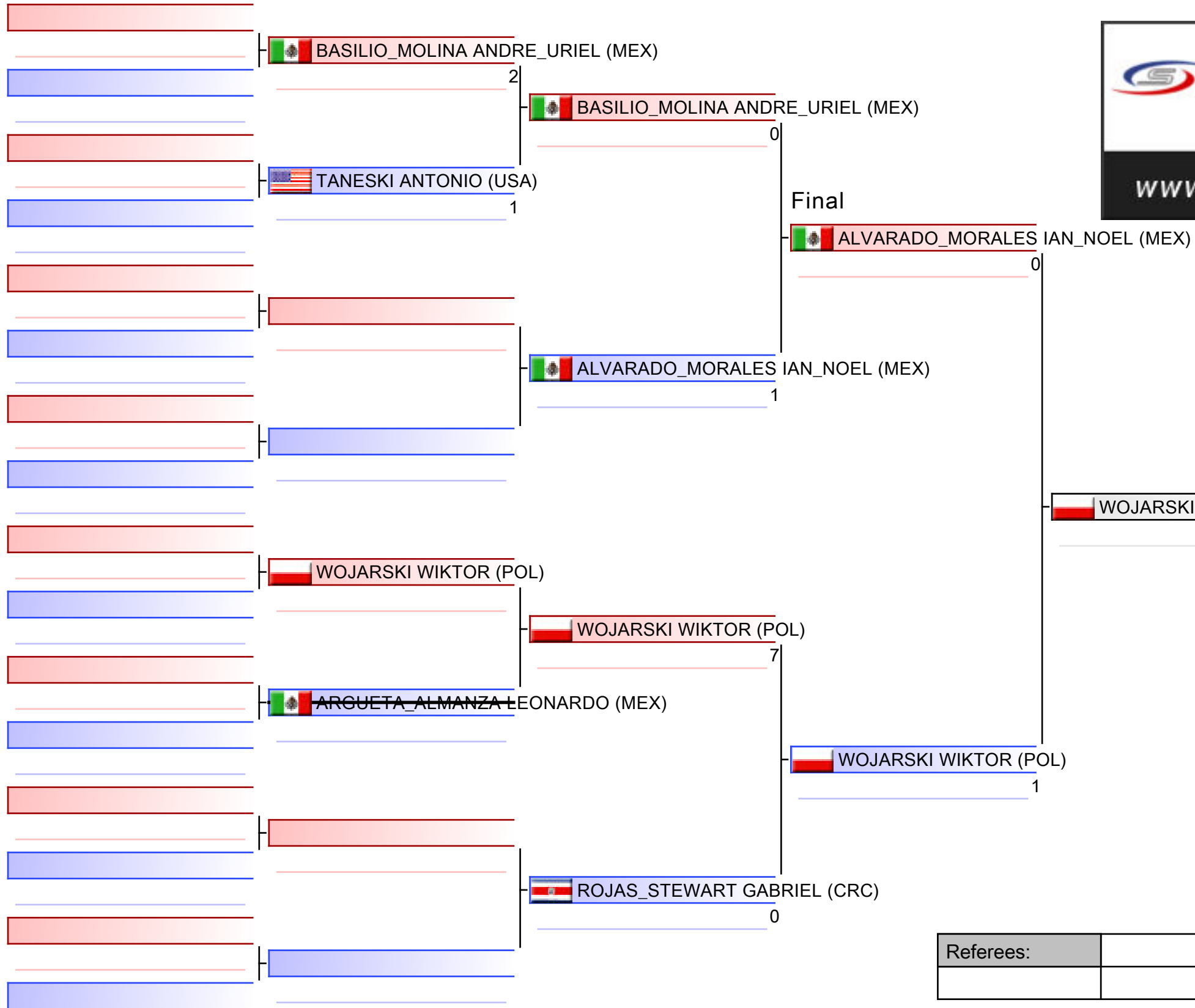

1. WOJARSKI WIKTOR (POL)
2. ALVARADO_MORALES IAN_NOEL (MEX)
3. BASILIO_MOLINA ANDRE_URIEL (MEX)
3. ROJAS_STEWART GABRIEL (CRC)

Referees:			

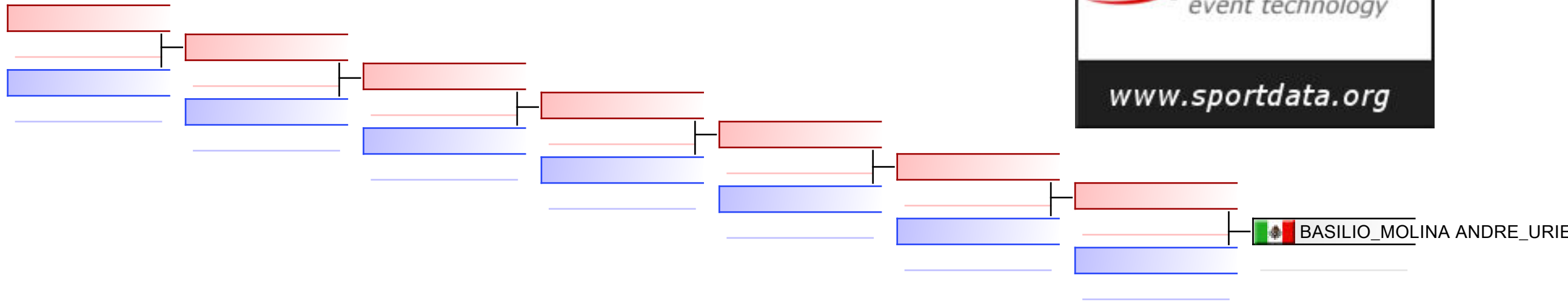

REPECHAGE: (1)

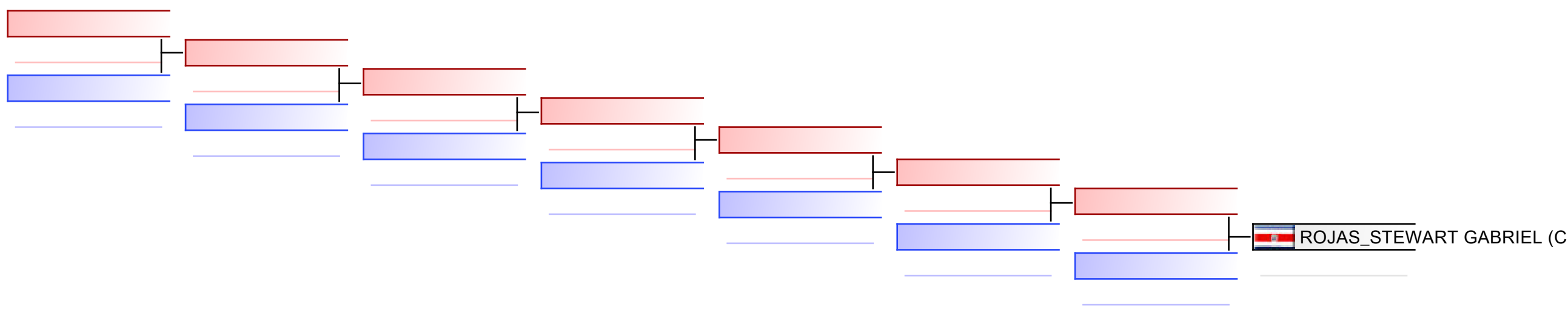

Referees:							
-----------	--	--	--	--	--	--	--

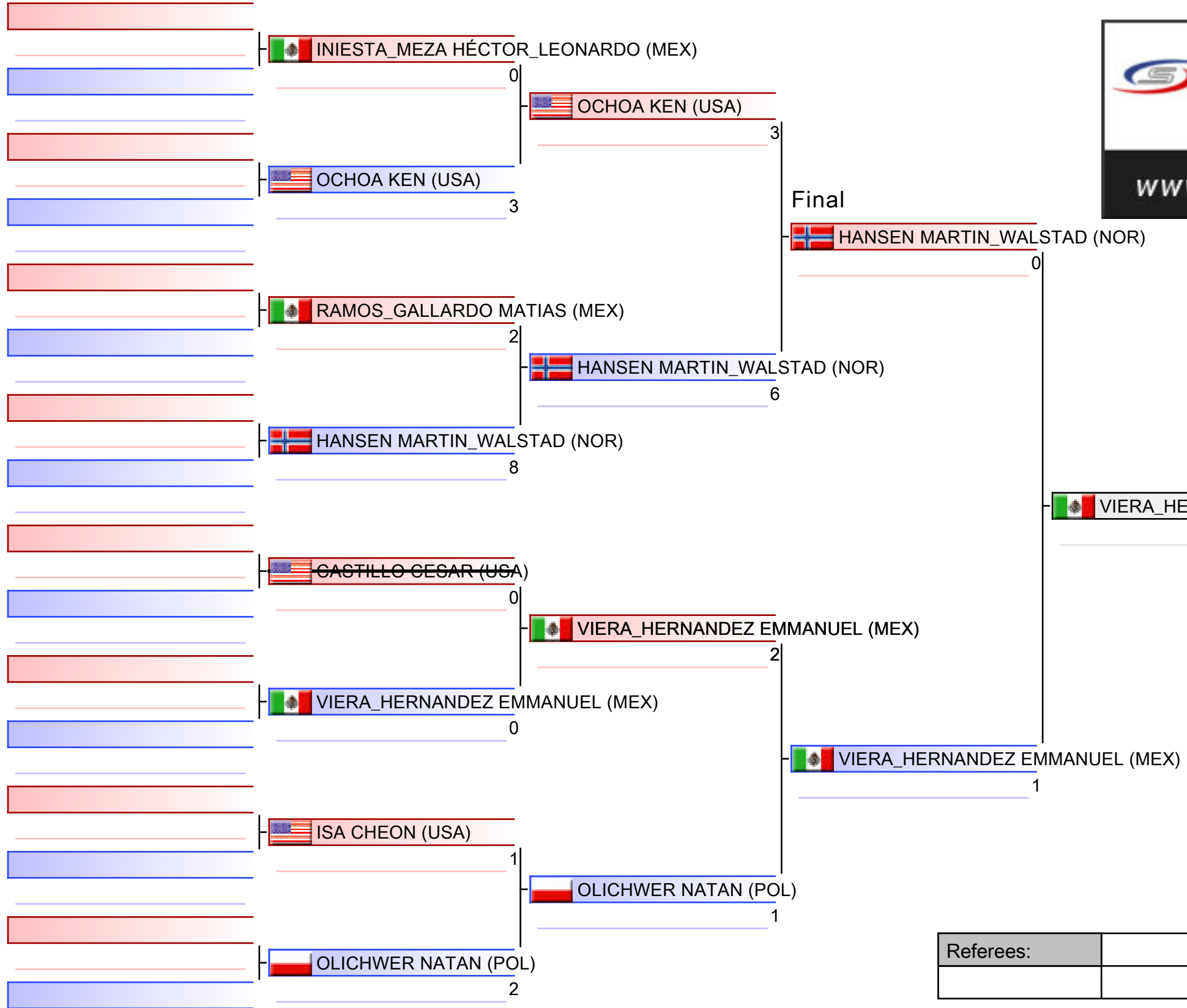

1. VIERA_HERNADEZ EMMANUEL (MEX)
2. HANSEN MARTIN_WALSTAD (NOR)
3. OLICHWER NATAN (POL)
3. OCHOA KEN (USA)
5. RAMOS_GALLARDO MATIAS (MEX)

Referees:			

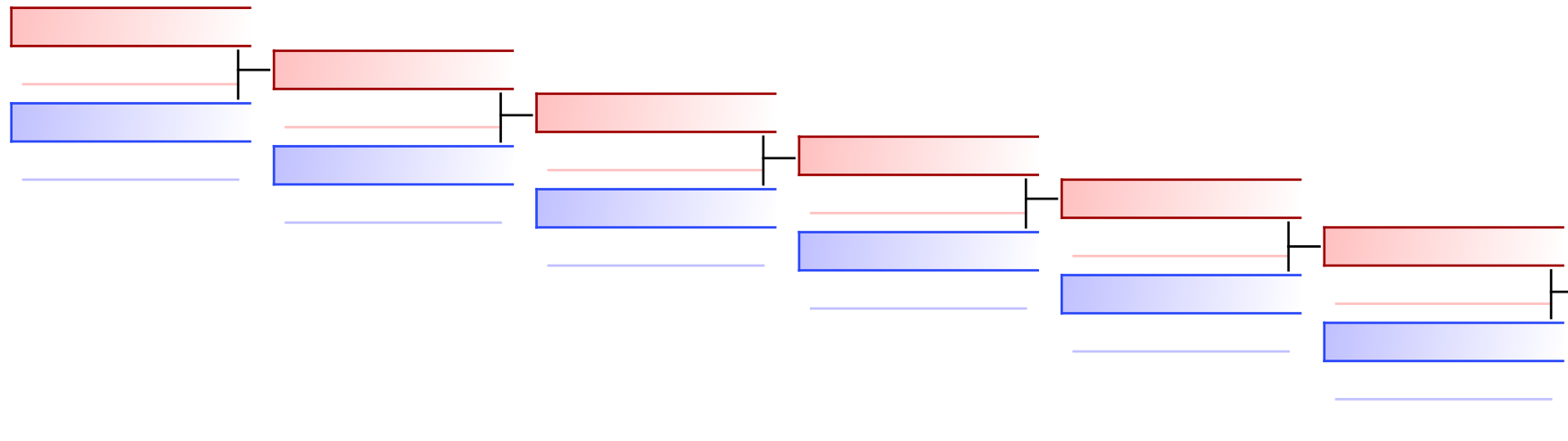

RAMOS\_GALLARDO MATIAS (MEX) 0  
 OCHOA KEN (USA) 2

REPECHAGE: (1)

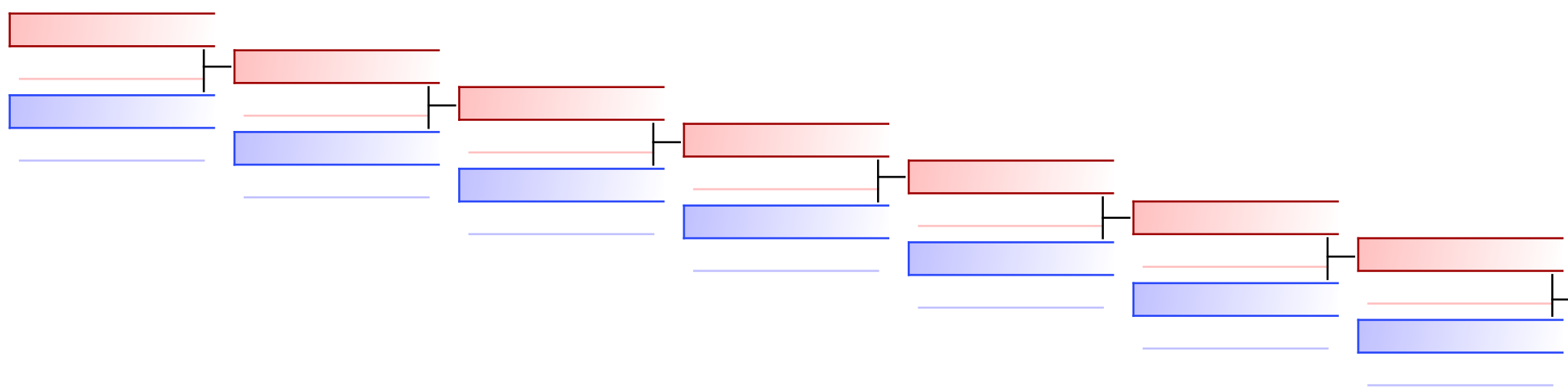

OLICHWER NATAN (POL)

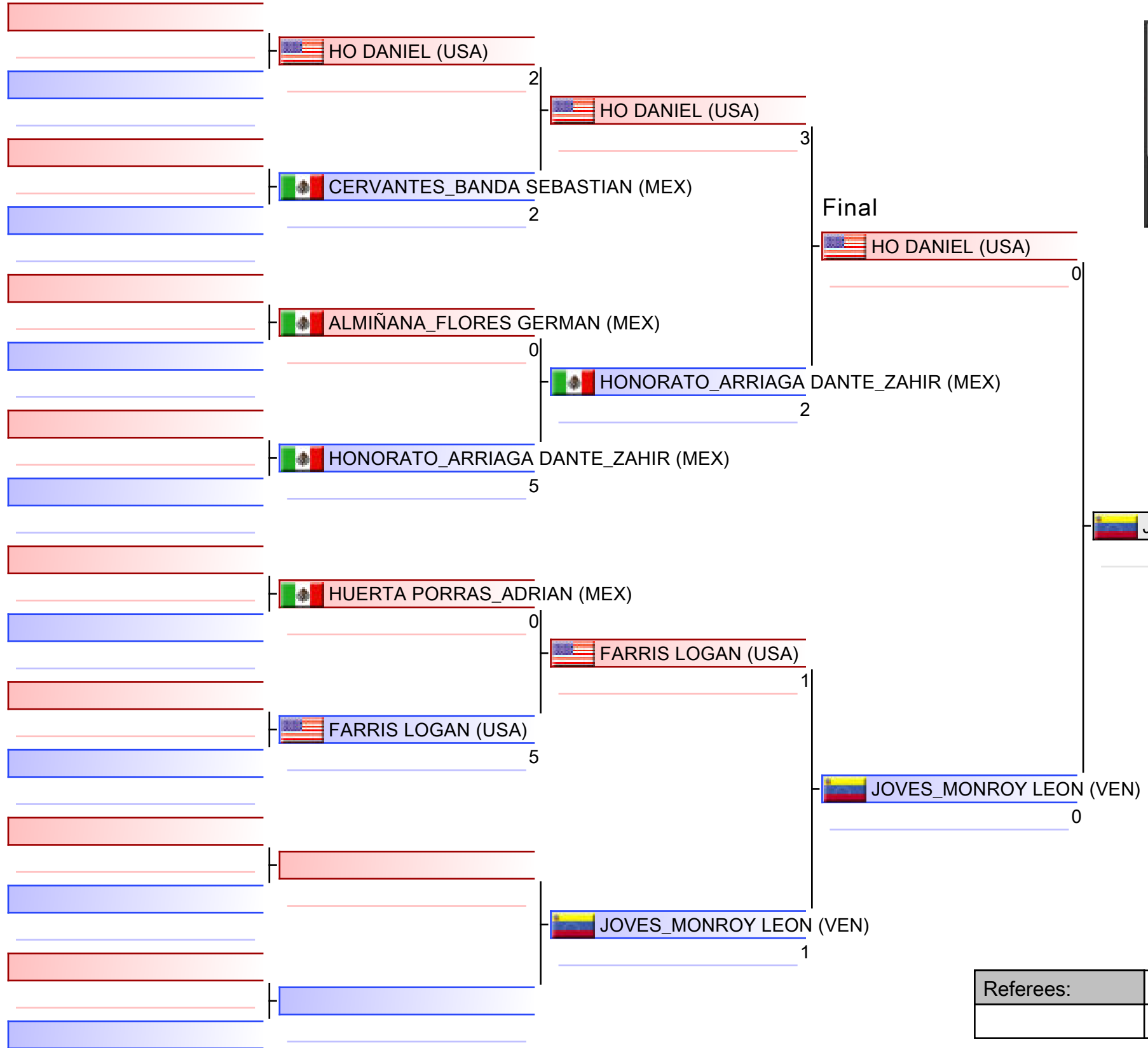

Referees:							
-----------	--	--	--	--	--	--	--

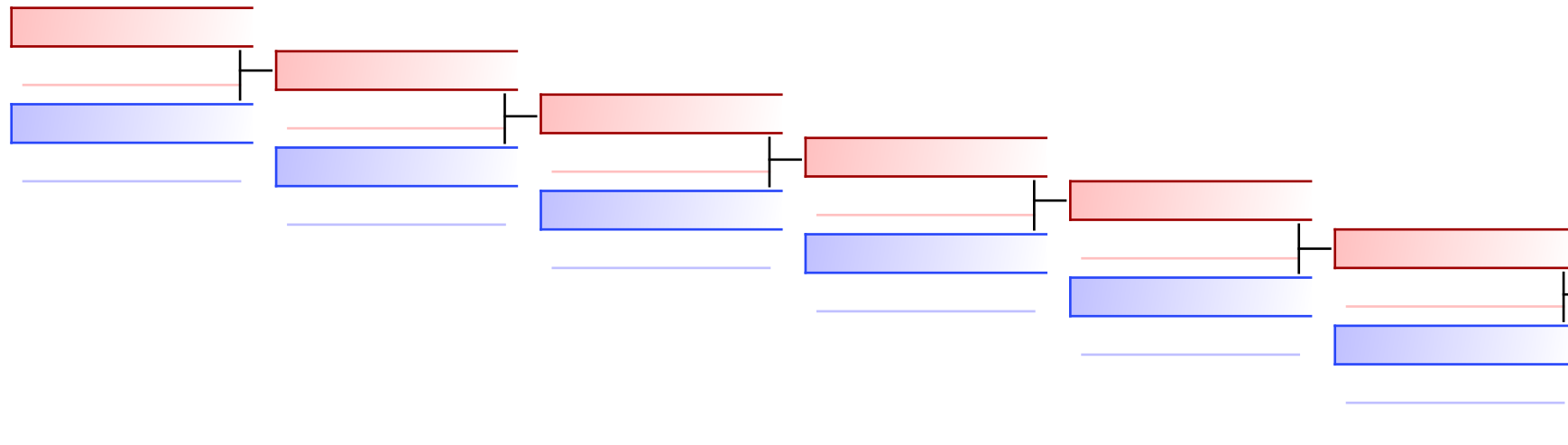

1. JOVES_MONROY LEON (VEN)
2. HO DANIEL (USA)
3. FARRIS LOGAN (USA)
3. CERVANTES_BANDA SEBASTIAN (MEX)
5. HONORATO_ARRIAGA DANTE_ZAHIR (MEX)

Referees:			



 CERVANTES\_BANDA SEBASTIAN (MEX)  
 5  
 CERVANTES\_BANDA SEBASTIA  
 HONORATO\_ARRIAGA DANTE\_ZAHIR (MEX)  
 4

REPECHAGE: (1)

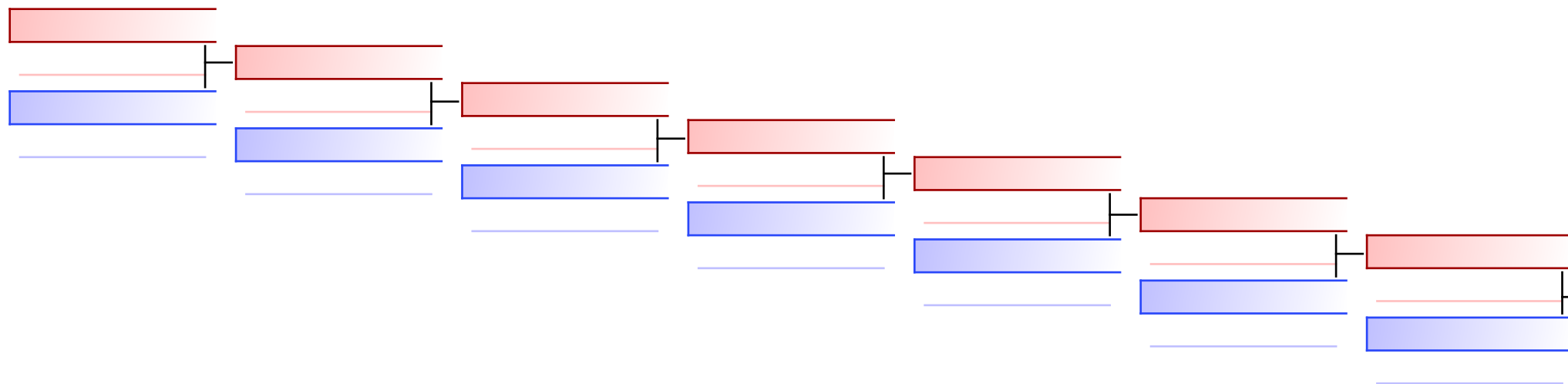

 FARRIS LOGAN (USA)

Referees:							
-----------	--	--	--	--	--	--	--





www.sportdata.org

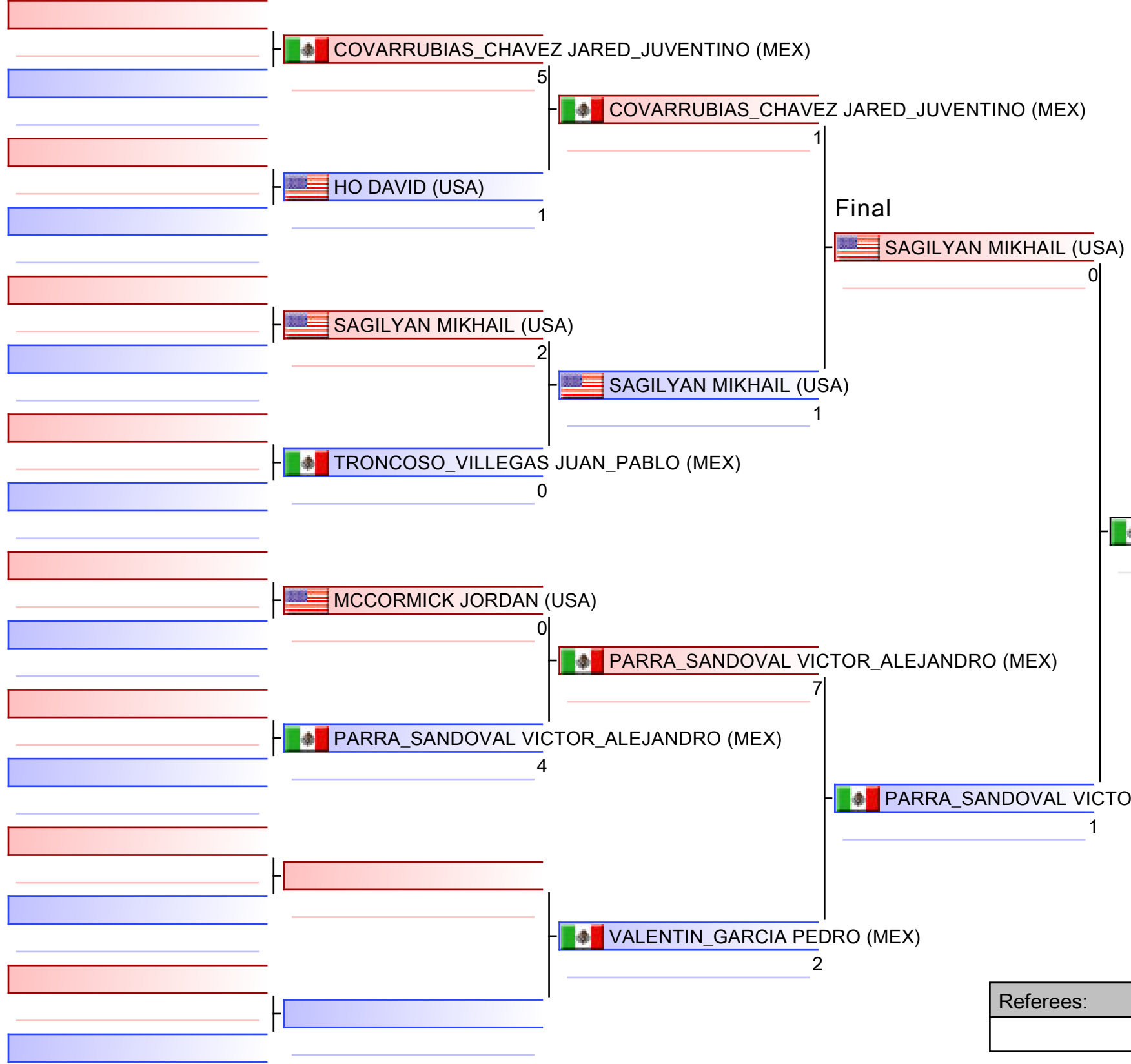

1. PARRA_SANDOVAL VICTOR_ALEJANDRO (MEX)
2. SAGILYAN MIKHAIL (USA)
3. COVARRUBIAS_CHAVEZ JARED_JUVENTINO (MEX)
3. VALENTIN_GARCIA PEDRO (MEX)
5. TRONCOSO_VILLEGAS JUAN_PABLO (MEX)
5. MCCORMICK JORDAN (USA)

Referees:			

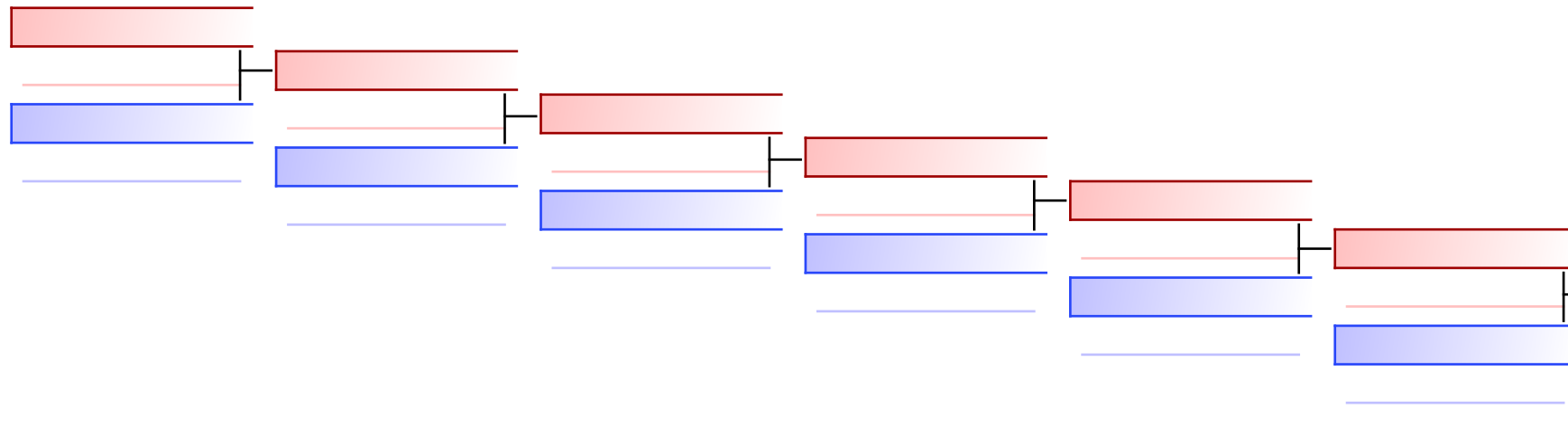

TRONCOSO\_VILLEGAS JUAN\_PABLO (MEX) | 0  
 COVARRUBIAS\_CHAVEZ JARED | 5  
 COVARRUBIAS\_CHAVEZ JARED\_JUVENTINO (MEX)

REPECHAGE: (1)

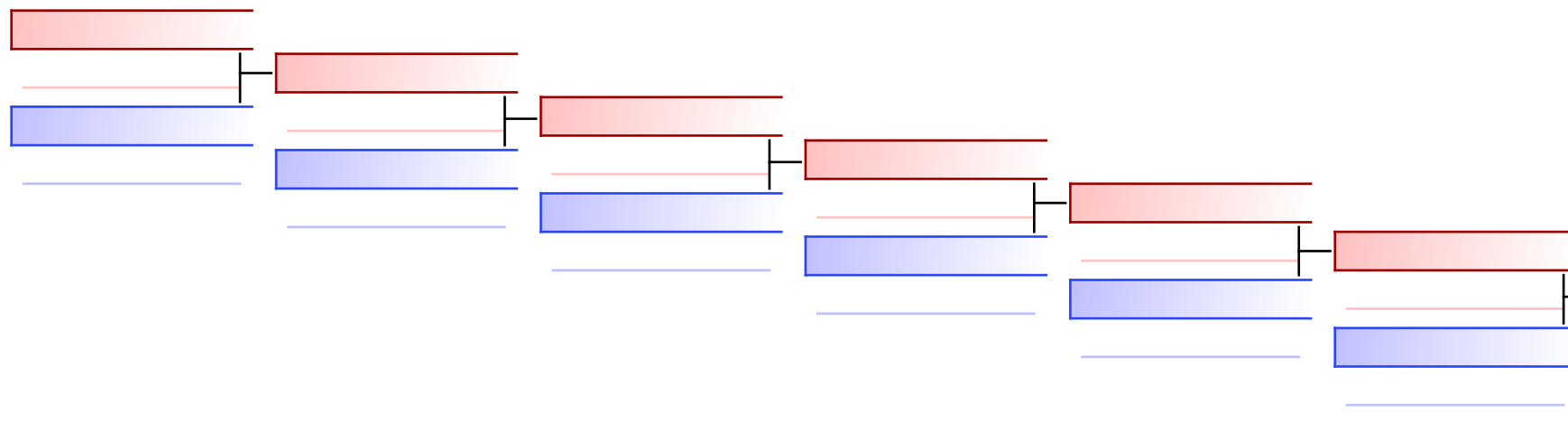

MCCORMICK JORDAN (USA) | 2  
 VALENTIN\_GARCIA PEDRO (MEX) | 4  
 VALENTIN\_GARCIA PEDRO (MEX)

Referees:							
-----------	--	--	--	--	--	--	--

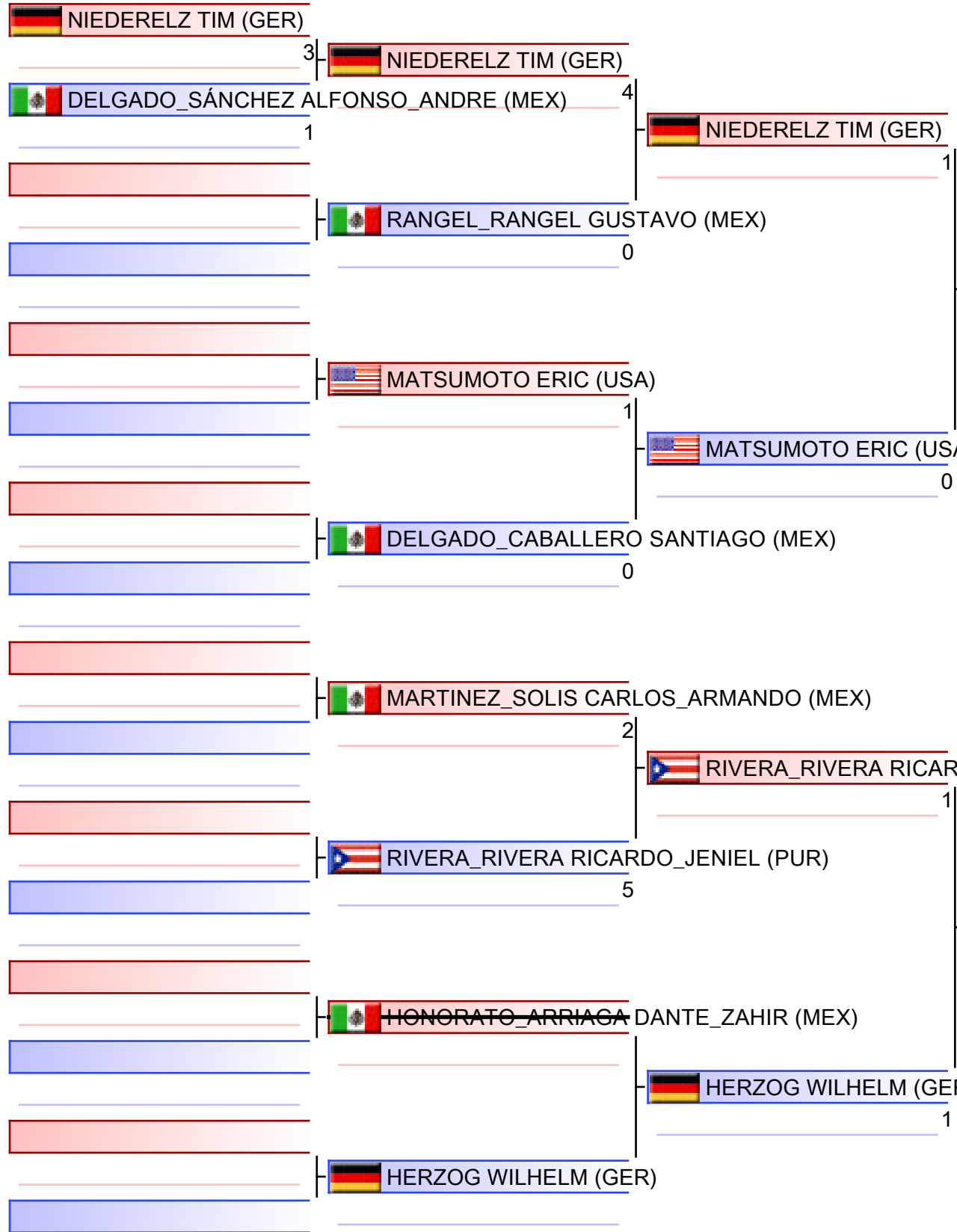

1. NIEDERELZ TIM (GER)
2. RIVERA_RIVERA RICARDO_JENIEL (PUR)
3. HERZOG WILHELM (GER)
3. DELGADO_SÁNCHEZ ALFONSO_ANDRE (MEX)
5. MARTINEZ_SOLIS CARLOS_ARMANDO (MEX)
5. MATSUMOTO ERIC (USA)
7. RANGEL_RANGEL GUSTAVO (MEX)

Referees:			

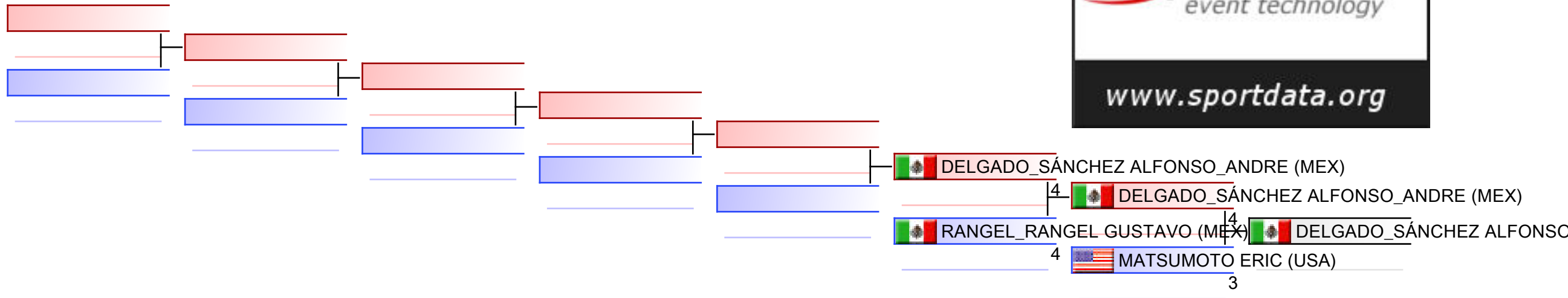

REPECHAGE: (1)

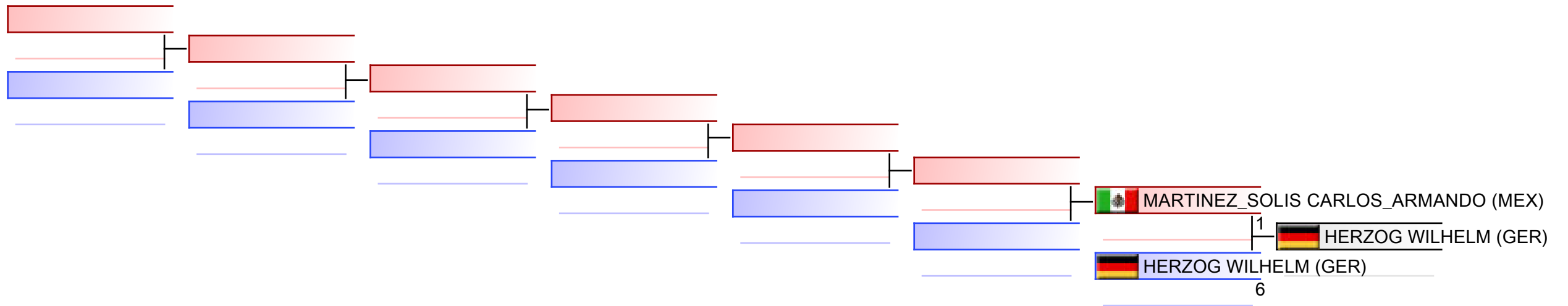

Referees:							
-----------	--	--	--	--	--	--	--



## Karate1 Youth League - Acapulco 2022 - 2022-01-21

### Official Results

Cadet Kata Female			
1	BUI MAI-LINH		FRA - FRANCE
2	CASTRO MOLINA CAMILA		VEN - VENEZUELA
3	OLIGINO DIANA		VEN - VENEZUELA
3	NAVARRETE GABRIELA		USA - UNITED STATES
5	AGUILAR CRUZ NICOLE		ECU - ECUADOR
5	CARDONA GRAJALES SARA		COL - COLOMBIA
7	CHU JADE LI-YA MISAKI		USA - UNITED STATES
7	GONZALEZ MEZTLI RENATA		MEX - MEXICO
9	GALVAN RODRIGUEZ MICHELLE		MEX - MEXICO
9	LOBO ARAUZ SAMANTHA		CRC - COSTA RICA
11	HERRERA CASTRO ERICKA SUZETHE		MEX - MEXICO
11	QUINTERO AVAS CIELO		MEX - MEXICO
13	ALVARADO PORRAS ANA MARIA		CRC - COSTA RICA
13	DE LA O GARCIA XIMENA		MEX - MEXICO
15	CASTRO TREJOS LIZETH MANUELA		COL - COLOMBIA
15	SOLIS BELLA LAN		USA - UNITED STATES
17	RAJNANDHINI JOANNE		CAN - CANADA
17	VELIZ RODRIGUEZ KARIN MARIANA		GUA - GUATEMALA
17	CAMPOS GUZMAN DORIAN GISELIS		PUR - PUERTO RICO
17	AGUILAR ALBIZURES MARIA RENEE		GUA - GUATEMALA
21	SIBAJA CASTRO MARIEDITH		CRC - COSTA RICA
21	LEVY HARARI ANDREA		MEX - MEXICO
21	SOSA PIÑA NORMA ANGELIZA		MEX - MEXICO
21	SALAME ROZILLIO GECY		MEX - MEXICO
25	CASILLAS OCHOA MELISSA MONSERRAT		MEX - MEXICO
25	CALVO LEAL ARIELA		CRC - COSTA RICA
25	SKINNER LUCY		USA - UNITED STATES
29	PARRA GRAJEDA CAMILA		MEX - MEXICO

Cadet Kata Male			
1	GRUITIA MATTHEW B		CAN - CANADA
2	PINHEIRO PEDRO		USA - UNITED STATES
3	NACU MATEO		USA - UNITED STATES
3	NARVAEZ MARCO		ECU - ECUADOR
5	POLLEY CHASE		USA - UNITED STATES
5	MACIAS CASTELLANOS JUAN PABLO		MEX - MEXICO
7	CASTILLO BARRIOS JOSHUA DANERY		GUA - GUATEMALA
7	GRANADOS HERRERA ANGEL EMIIO		ESA - EL SALVADOR
9	BOJORQUEZ CERVANTES HECMAR ARNOLDO		MEX - MEXICO
9	NAKAJIMA-WU AIDAN		USA - UNITED STATES
11	GARCIA VALADEZ JUAN PABLO		MEX - MEXICO
11	MONTALVETTI PATRICIO		ARG - ARGENTINA
13	LOPEZ HERNANDEZ NEFTALI		MEX - MEXICO
13	DÍAZ DE LEON MAXIMO		MEX - MEXICO



## Karate1 Youth League - Acapulco 2022 - 2022-01-21

### Official Results

15	MONROY LOPEZ HUGO GAEL		MEX - MEXICO	
15	OROZCO GALICIA DANTE ALEJANDRO		MEX - MEXICO	
17	GONZALEZ PAZ CARLOS ERNESTO		ESA - EL SALVADOR	
17	OLLAGNERO GIOVANNI		ITA - ITALY	
17	BUCAY MIZRAHI JONATHAN		MEX - MEXICO	
17	NGUYEN ALEX		USA - UNITED STATES	
21	ARÁMBULA PADILLA ERYNN ZAHID		MEX - MEXICO	
21	ROJAS SANCHEZ ARATH SAID		MEX - MEXICO	
21	MORENO FLORES GUILLERMO ZABDIEL		MEX - MEXICO	
21	ATTARD ZACHARY		ENG - ENGLAND	
25	GARZA VIZCAINO JOSE MARCELO		MEX - MEXICO	
25	PADILLA NAVARRO MARIO ANDRE		MEX - MEXICO	
25	SERENO OSCAR		MEX - MEXICO	
25	ZAVALA MERCADO JOSE JUAN		MEX - MEXICO	
29	RUIZ GARCIA LUIS CARLOS		MEX - MEXICO	
29	MIZRAHI KALACH SONY		MEX - MEXICO	

#### Cadet Kumite Female -47 kg

1	THIEL ZOE		GER - GERMANY	
2	DOPIERALSKA ZUZANNA		POL - POLAND	
3	MOJICA BARRIOS VALERIA FERNANDA		MEX - MEXICO	
3	CISNEROS ALMA ARITZU		MEX - MEXICO	
5	CONTRERAS MUÑOZ ANA KARENI		MEX - MEXICO	
5	CALVO LEAL ARIELA		CRC - COSTA RICA	
7	RAJNANDHINI JOANNE		CAN - CANADA	

#### Cadet Kumite Female -54 kg

1	VELIZ RODRIGUEZ KARIN MARIANA		GUA - GUATEMALA	
2	PALOMINO VIANNA		USA - UNITED STATES	
3	CASTRO MOLINA CAMILA		VEN - VENEZUELA	
3	MUSSWEILER MIA		GER - GERMANY	
5	PARRA SANDOVAL LAURA ALEJANDRA		MEX - MEXICO	
5	LUNA RIVERA CARRIE BARBARA MABEL		GUA - GUATEMALA	
7	AGUILAR CRUZ NICOLE		ECU - ECUADOR	
7	SAZHINA VERONIKA		RUS - RUSSIAN FEDERATION	

#### Cadet Kumite Female 54+ kg

1	VALENTIN GARCIA LIZETTE BASILISA		MEX - MEXICO	
2	NAVARRETE GABRIELA		USA - UNITED STATES	
3	QUINTERO AVAS CIELO		MEX - MEXICO	
3	MUZIK TAŠA		SLO - SLOVENIA	
5	ALVARADO PORRAS ANA MARIA		CRC - COSTA RICA	
5	QUINTERO FLORES GEOMARA		MEX - MEXICO	
7	DIAZ ALVAREZ ANA LUCIA		MEX - MEXICO	

#### Cadet Kumite Male -52 kg

1	ROMBEAUX MATT		BEL - BELGIUM	
---	---------------	--	---------------	--



## Karate1 Youth League - Acapulco 2022 - 2022-01-21

### Official Results

2	CRUZ ROMERO DANIEL ALEJANDRO		MEX - MEXICO	
3	REYES ALCANTAR GERARDO DE JESUS		MEX - MEXICO	
3	THIERBACH LUCA		GER - GERMANY	
5	LOAIZA MARTINEZ BRUNO		MEX - MEXICO	
5	DORTA JEAN		USA - UNITED STATES	
7	LOPEZ ZACK		USA - UNITED STATES	
7	ERNWEIN THOMAS		FRA - FRANCE	
9	ATTARD ZACHARY		ENG - ENGLAND	

#### Cadet Kumite Male -57 kg

1	YOSHI MIZUKAMI HAYATO		MEX - MEXICO	
2	NAKAJIMA-WU AIDAN		USA - UNITED STATES	
3	NACU MATEO		USA - UNITED STATES	
3	CRUZ BRYAN		USA - UNITED STATES	
5	JIMENEZ ANDRES		MEX - MEXICO	
5	KANAPARTHI ANSHUL		USA - UNITED STATES	
7	MONDRAGON TORRES ANTONIO IESHUA		MEX - MEXICO	
7	FERNANDEZ VICTOR		MEX - MEXICO	

#### Cadet Kumite Male -63 kg

1	LEAL MORENO IKER		ESP - SPAIN	
2	ZUNIGA SPÄTHE ROBIN MATEO		GER - GERMANY	
3	ŽIBRET BOR		SLO - SLOVENIA	
3	HELIMI SABRI		FRA - FRANCE	
5	SWANSON CONNOR		USA - UNITED STATES	
5	BOLAÑOS TREVIÑO RICARDO DIETER		MEX - MEXICO	
7	SUÁREZ GARZA RAFAEL		MEX - MEXICO	
7	MERINO HERNÁNDEZ JOSUÉ JACOB		MEX - MEXICO	

#### Cadet Kumite Male -70 kg

1	ZERPA ALEJANDRO		VEN - VENEZUELA	
2	MONTALVETTI PATRICIO		ARG - ARGENTINA	
3	TURPIN ABELLAN ANGEL		ESP - SPAIN	
3	REYNA MARTINEZ GAEL 1		MEX - MEXICO	
5	MENDOZA RAMÍREZ CHRISTIAN ALEXANDER		MEX - MEXICO	
5	RIVERA ADRIAN		MEX - MEXICO	
7	ZAVALA MERCADO JOSE JUAN		MEX - MEXICO	
7	PALMA ROMERO JULIO CESAR		MEX - MEXICO	

#### Cadet Kumite Male 70+ kg

1	GONDI NIKOLA		CRO - CROATIA	
2	TANESKI KRISTIAN		USA - UNITED STATES	
3	OROZCO PÉREZ LIAM NOEL		MEX - MEXICO	
3	GARCIA GARCIA JESUS FRANCISCO		MEX - MEXICO	
5	CASTRO YAIR		MEX - MEXICO	
5	MICHEJLIS KEVIN		GER - GERMANY	
7	TROYO RAMOS ISAAC		MEX - MEXICO	



## Karate1 Youth League - Acapulco 2022 - 2022-01-21

### Official Results

7	MORENO FLORES GUILLERMO ZABDIEL		MEX - MEXICO
---	---------------------------------	--	--------------

#### Junior Kata Female

1	VIERA HERNANDEZ MAYRA EMILY		MEX - MEXICO
2	TAGLIAFIERRO CHIARA		ITA - ITALY
3	GARCIA CORONEL SOFIA		VEN - VENEZUELA
3	MIÑANO LANYFER		SUI - SWITZERLAND
5	MARTINEZ ZAPATA ANA YURIDIA		MEX - MEXICO
5	MARTINEZ ESCOBEDO AMERICA VALERIA		MEX - MEXICO
7	WILLIAMS DANNI		ENG - ENGLAND
7	MARTINEZ RETA FERNANDA		MEX - MEXICO
9	LARIS SANTOS DENISSE		MEX - MEXICO
9	OCANA LAYLA		USA - UNITED STATES
11	DENA ALVAREZ JOANA MARIA		MEX - MEXICO
11	ESPIRITO SANTO DIAS NICOLE		USA - UNITED STATES
13	LOPEZ NOROÑA SARA ANELIS		MEX - MEXICO
13	HUYET DUMONG JUSTINE		FRA - FRANCE
15	SWANSON KAITLIN		USA - UNITED STATES
15	NACU MAILE		USA - UNITED STATES
17	ANGULO SOTO LIZBETH GUADALUPE		MEX - MEXICO
17	SANTOS PAYAN LIZETH		MEX - MEXICO
17	PEREZ MONTOYA HANNIA		MEX - MEXICO
17	RIVERA AGUIRRE ANNA SOFIA		MEX - MEXICO
21	TAPIA SOLANO IBETH LILITH		MEX - MEXICO
21	SANTIAGO SANCHEZ MARIA FERNANDA		MEX - MEXICO
21	VAZQUEZ MOLINA JAZIVE BENIGBÉ		MEX - MEXICO
21	CLOW AMELIA		ENG - ENGLAND
25	ZAMUDIO FELIX YANETH		MEX - MEXICO
25	MILLÁN ASTRID		MEX - MEXICO
25	KORMAN CHRISTINA		USA - UNITED STATES
25	ALQUINTA NABEEL		CHI - CHILE
29	SOTO TERRAZAS JUANA PAOLA		MEX - MEXICO

#### Junior Kata Male

1	MADRID TAPIA RODRIGO ALEJANDRO		USA - UNITED STATES
2	PAEZ JOAQUIN		ECU - ECUADOR
3	SALDAÑA MARKUS EMILIO		MEX - MEXICO
3	RETIZ CAMPOS RODRIGO ADRIAN		MEX - MEXICO
5	BERRETTA DYLAN		CAN - CANADA
5	ONAGA TROY		USA - UNITED STATES
7	SAGILYAN EDUARD		USA - UNITED STATES
7	CASTILLO RAMOS RODRIGO		MEX - MEXICO
9	VEGA BATIZ CARLOS SANTIAGO		MEX - MEXICO
9	ADI DAVID		USA - UNITED STATES
11	DOMINGUEZ DANIEL		PAN - PANAMA
11	SALAS ALONSO LUIS LEONARDO		MEX - MEXICO





## Karate1 Youth League - Acapulco 2022 - 2022-01-21

### Official Results

13	LOK AIDAN		USA - UNITED STATES	
13	NEAL JACKSON		USA - UNITED STATES	
15	CASTRO SEGURA ERIC GIOVANNI		MEX - MEXICO	
15	GRANADOS HERRERA OSCAR RENE		ESA - EL SALVADOR	
17	DIAZ MAYTORENA PEDRO MARIO		MEX - MEXICO	

#### Junior Kumite Female -48 kg

1	GODOY MAGDALENA		CHI - CHILE	
2	GARCIA CORONEL SOFIA		VEN - VENEZUELA	
3	ORANTES MAGANA SOFIA ALEJANDRA		ESA - EL SALVADOR	
3	OTT SIDNEY-MICHELLE		GER - GERMANY	
5	SALINAS HERNANDEZ EMILIA		MEX - MEXICO	

#### Junior Kumite Female -53 kg

1	RABHI DOUAA		GER - GERMANY	
2	HUNT RUBY		ENG - ENGLAND	
3	PETAN ELA		SLO - SLOVENIA	
3	ESPINOZA COVARRUBIAS KARINA LORELEI		MEX - MEXICO	
5	NIETO FLORES IDALIA		MEX - MEXICO	
5	VIERA HERNANDEZ MAYRA EMILY		MEX - MEXICO	
7	HERRERA AYALA ANA CAROLINA		MEX - MEXICO	
7	TORRES LOPEZ JAQUELINE GUADALUPE		MEX - MEXICO	
9	LOPEZ NOROÑA SARA ANELIS		MEX - MEXICO	

#### Junior Kumite Female -59 kg

1	CACKO MIA		CRO - CROATIA	
2	SCHULZ NELL		GER - GERMANY	
3	EJJA IMAN		BEL - BELGIUM	
3	LOPEZ LEON DANIELA ITZEL		MEX - MEXICO	
5	AMADOR CELIS VERONICA GERALDINE		MEX - MEXICO	
5	VINCENT ROBIN		ENG - ENGLAND	
7	TAPIA SOLANO IBETH LILITH		MEX - MEXICO	
7	CONTRERAS LARA ARANTXA		MEX - MEXICO	
9	TOVAR GONZALEZ FERNANDA ABIGAIL		MEX - MEXICO	

#### Junior Kumite Female 59+ kg

1	AGUDELO MARIA ALEJANDRA		COL - COLOMBIA	
2	ŽIBRET ZALA MARIA		SLO - SLOVENIA	
3	EWING NEVE		SCO - SCOTLAND	
3	DANISZEWSKA JULIA		POL - POLAND	
5	GARDUÑO SILVA DULCE MELISSA		MEX - MEXICO	
5	RIEDEL HANNAH		GER - GERMANY	

#### Junior Kumite Male -55 kg

1	ARCE ZUNIGA BASTIAN		CHI - CHILE	
2	RENDÓN ZAVALA KEVIN		MEX - MEXICO	
3	FIGUEROA CHULAK BENJAMIN		CHI - CHILE	



## Karate1 Youth League - Acapulco 2022 - 2022-01-21

### Official Results

3	ONAGA TROY		USA - UNITED STATES	
5	RAMIREZ HERNANDEZ ANGEL ENRIQUE		MEX - MEXICO	
5	GRANADOS HERRERA OSCAR RENE		ESA - EL SALVADOR	
7	SANTOS HERNÁNDEZ OSCAR MOISES		MEX - MEXICO	

#### Junior Kumite Male -61 kg

1	BATLO RAPHAEL		FRA - FRANCE	
2	SOLIS MATEO		USA - UNITED STATES	
3	DORTA JANCO		USA - UNITED STATES	
3	BAUTISTA ESTEBAN		MEX - MEXICO	
5	DZIUDA DOMINIK		POL - POLAND	
5	BUENROSTRO ACOSTA JESÚS HERIBERTO		MEX - MEXICO	
7	SOLIS BRAZON JOSE DAVID		VEN - VENEZUELA	
7	GONZALEZ MUÑOZ VICTOR MANUEL		MEX - MEXICO	
9	GRANDE GARCIA SAUL		MEX - MEXICO	

#### Junior Kumite Male -68 kg

1	GONÇALVES GUILHERME		POR - PORTUGAL	
2	CHACON MAZARIEGOS DIEGO ERNESTO		GUA - GUATEMALA	
3	KASTURI SAHIL		USA - UNITED STATES	
3	CRUZ KEVIN		USA - UNITED STATES	
5	FULLMAN BRADEN		USA - UNITED STATES	
5	TAMAYO MORALES ANTONIO NIKOLAS		MEX - MEXICO	
7	ARGUETA ALMANZA AXEL FABIAN		MEX - MEXICO	

#### Junior Kumite Male -76 kg

1	SCHMITZ SIMON		GER - GERMANY	
2	HERSCHEL NIJUEL		USA - UNITED STATES	
3	SAUNDERS-LONG TRISTAN		USA - UNITED STATES	
3	ESTRADA LOPEZ ARISTIDES JESUS		MEX - MEXICO	
5	MARRIMON GADSON DARRYL		USA - UNITED STATES	
5	SANDOVAL GARCIA IAN		MEX - MEXICO	

#### Junior Kumite Male 76+ kg

1	SAGILYAN EDUARD		USA - UNITED STATES	
2	CRUMRINE IAN		USA - UNITED STATES	
3	FIUME ROJAS SEBASTIAN		VEN - VENEZUELA	
3	DEUTSCH PASCAL		GER - GERMANY	
5	SANCHEZ MARQUEZ JOAQUIN ADOLFO		VEN - VENEZUELA	
7	BARRERAS LINARES JORGE ADALBERTO		MEX - MEXICO	

#### U14 Kata Female

1	PEREZ ALESSANDRA		USA - UNITED STATES	
2	CHU SIENNA MIYU		USA - UNITED STATES	
3	FERREIRA VIELMA STEPHANY VALENTINA		VEN - VENEZUELA	
3	DEODHARI SIERRA		USA - UNITED STATES	
5	LOPEZ ARCE SASHA		CRC - COSTA RICA	



## Karate1 Youth League - Acapulco 2022 - 2022-01-21

### Official Results

5	FRIAS DESSIRE		PAN - PANAMA	
7	QUINTERO AVAS YUBIA MARINA		MEX - MEXICO	
7	SERRANO AGUILAR VALERIA		ESA - EL SALVADOR	
9	HERRERA RODRIGUEZ ANDREA		MEX - MEXICO	
9	ONTIVEROS DURAN ANDREA ISABELLA		MEX - MEXICO	
11	TAMAYO MORALES SENECA		MEX - MEXICO	

#### U14 Kata Male

1	GRECO GIANLUCA		VEN - VENEZUELA	
2	GALMICHE ANGEL YERIK		MEX - MEXICO	
3	ISA CHEON		USA - UNITED STATES	
3	HO DANIEL		USA - UNITED STATES	
5	RODRIGUEZ LUIS		MEX - MEXICO	
5	MATSUMOTO ERIC		USA - UNITED STATES	
7	HO DAVID		USA - UNITED STATES	
7	CHOJNACKI BARTOSZ		POL - POLAND	
9	GONZALEZ KARIM OZIEL		MEX - MEXICO	
11	DELGADO SANCHEZ ALFONSO ANDRE		MEX - MEXICO	
13	BALDERRAMA PALACIOS ENRIQUE ALEJANDRO		MEX - MEXICO	

#### U14 Kumite Female -42 kg

1	DREHMANN EMILY-CHIARA		GER - GERMANY	
2	LÓPEZ CASILLAS TANIA ESMERALDA		MEX - MEXICO	
3	LOPEZ ARCE SASHA		CRC - COSTA RICA	
3	DELGADO CABALLERO ELISA		MEX - MEXICO	

#### U14 Kumite Female -47 kg

1	HELLEN ILI		GER - GERMANY	
2	SINGLETON CHARLOTTE		USA - UNITED STATES	
3	FRIAS DESSIRE		PAN - PANAMA	
3	BOLAÑOS TREVIÑO NAZARETH CHIIHIROXISHI		MEX - MEXICO	
5	AMEZCUA CASTILLO PAOLA MICHEL		MEX - MEXICO	
5	OSORIO GÓMEZ RENATA SOFIA		MEX - MEXICO	

#### U14 Kumite Female 47+ kg

1	EWING MAIA		SCO - SCOTLAND	
2	GRÁFE LOTTE		GER - GERMANY	
3	RAMIREZ MIRANDA FERNANDA MARISOL		MEX - MEXICO	
3	SERRANO AGUILAR VALERIA		ESA - EL SALVADOR	
5	MENDOZA PÉREZ XADANI XIOMARA		MEX - MEXICO	
5	QUINTERO AVAS YUBIA MARINA		MEX - MEXICO	

#### U14 Kumite Male +55 kg

1	WOJARSKI WIKTOR		POL - POLAND	
2	ALVARADO MORALES IAN NOEL		MEX - MEXICO	
3	BASILIO MOLINA ANDRÉ URIEL		MEX - MEXICO	



## Karate1 Youth League - Acapulco 2022 - 2022-01-21

### Official Results

3	ROJAS STEWART GABRIEL		CRC - COSTA RICA	
---	-----------------------	--	------------------	--

#### U14 Kumite Male -40 kg

1	VIERA HERNANDEZ EMMANUEL		MEX - MEXICO	
2	HANSEN MARTIN WALSTAD		NOR - NORWAY	
3	OLICHWER NATAN		POL - POLAND	
3	OCHOA KEN		USA - UNITED STATES	
5	RAMOS GALLARDO MATIAS		MEX - MEXICO	

#### U14 Kumite Male -45 kg

1	JOVES MONROY LEON		VEN - VENEZUELA	
2	HO DANIEL		USA - UNITED STATES	
3	FARRIS LOGAN		USA - UNITED STATES	
3	CERVANTES BANDA SEBASTIAN		MEX - MEXICO	
5	HONORATO ARRIAGA DANTE ZAHIR		MEX - MEXICO	

#### U14 Kumite Male -50 kg

1	PARRA SANDOVAL VICTOR ALEJANDRO		MEX - MEXICO	
2	SAGILYAN MIKHAIL		USA - UNITED STATES	
3	COVARRUBIAS CHAVEZ JARED JUVENTINO		MEX - MEXICO	
3	VALENTIN GARCIA PEDRO		MEX - MEXICO	
5	TRONCOSO VILLEGAS JUAN PABLO		MEX - MEXICO	
5	MCCORMICK JORDAN		USA - UNITED STATES	

#### U14 Kumite Male -55 kg

1	NIEDERELZ TIM		GER - GERMANY	
2	RIVERA RIVERA RICARDO JENIEL		PUR - PUERTO RICO	
3	HERZOG WILHELM		GER - GERMANY	
3	DELGADO SANCHEZ ALFONSO ANDRE		MEX - MEXICO	
5	MARTINEZ SOLIS CARLOS ARMANDO		MEX - MEXICO	
5	MATSUMOTO ERIC		USA - UNITED STATES	
7	RANGEL RANGEL GUSTAVO		MEX - MEXICO	